

0.5 dB LSB GaAs MMIC 6-BIT DIGITAL VARIABLE GAIN AMPLIFIER w/ SERIAL CONTROL, DC - 1 GHz



Typical Applications

The HMC681ALP5E is ideal for:

- IF & RF Applications
- Cellular/3G Infrastructure
- WiBro / WiMAX / 4G
- Microwave Radio & VSAT
- Test Equipment and Sensors

Functional Diagram

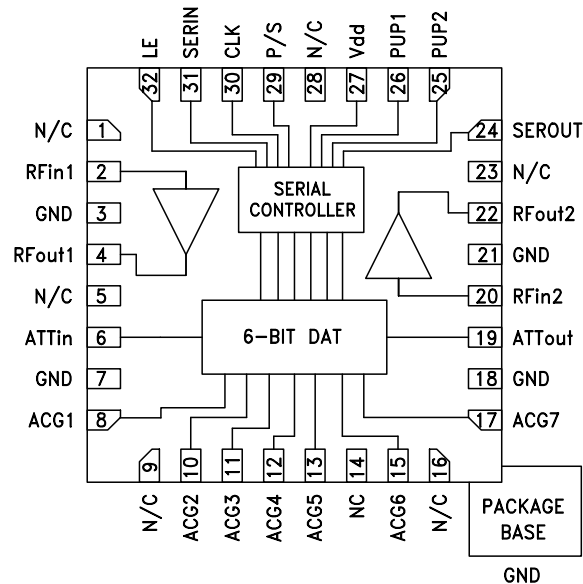

Features

- +13.5 dB to +45 dB Gain Control in 0.5 dB Steps
- High Output IP3: +36 dBm
- ±0.25 dB Typical Gain Step Error
- Single +5V Supply
- 32 Lead 5x5 mm SMT Package: 25 mm²

General Description

The HMC681ALP5E is a digitally controlled variable gain amplifier which operates from DC to 1 GHz, and can be programmed to provide anywhere from 13.5 dB, to 45 dB of gain, in 0.5 dB steps. The HMC681ALP5E delivers noise figure of 2.8 dB in its maximum gain state, with output IP3 of up to +36 dBm in any state. This serially controlled digital VGA incorporates off chip AC ground capacitors for near DC operation, making it suitable for a wide variety of RF and IF applications. The HMC681ALP5E is housed in a RoHS compliant 5x5 mm QFN leadless package, and provides the user with a highly integrated solution. This functionality is also available with parallel control as the HMC626ALP5E.

Electrical Specifications, $T_A = +25^\circ C$, $V_{dd} = V_s = P/S = +5V$

Parameter	Min.	Typ.	Max.	Min.	Typ.	Max.	Units
	50 - 350			350 - 1000			MHz
Gain (Maximum Gain State)	40	45		30	40		dB
Gain Control Range		31.5			31.5		dB
Input Return Loss		25			30		dB
Output Return Loss		20			17		dB
Gain Setting Accuracy: (Referenced to Maximum Gain State) All Gain States	± (0.15 + 3% of Relative Gain Setting) Max.			± (0.15 + 3% of Relative Gain Setting) Max.			dB
Output Power for 1 dB Compression		20			19		dBm
Output Third Order Intercept Point (Two-Tone Output Power= 5 dBm Each Tone)		38			36		dBm
Noise Figure		2.7			2.8		dB
Switching Characteristics tRISE, tFALL (10/90% RF) tON, tOFF (50% CTL to 10/90% RF)		60 120			60 120		ns ns
Total Supply Current (I _{dd} + 2*I _s)		184.5	225		184.5	225	mA

Information furnished by Analog Devices is believed to be accurate and reliable. However, no responsibility is assumed by Analog Devices for its use, nor for any infringements of patents or other rights of third parties that may result from its use. Specifications subject to change without notice. No license is granted by implication or otherwise under any patent or patent rights of Analog Devices. Trademarks and registered trademarks are the property of their respective owners.

For price, delivery, and to place orders: Analog Devices, Inc., One Technology Way, P.O. Box 9106, Norwood, MA 02062-9106 Phone: 781-329-4700 • Order online at www.analog.com Application Support: Phone: 1-800-ANALOG-D

HMC681A* PRODUCT PAGE QUICK LINKS

Last Content Update: 02/23/2017

[COMPARABLE PARTS](#)

View a parametric search of comparable parts.

[EVALUATION KITS](#)

- HMC681ALP5 Evaluation Board

[DOCUMENTATION](#)

Data Sheet

- HMC681A Data Sheet

[REFERENCE MATERIALS](#)

Quality Documentation

- Semiconductor Qualification Test Report: PHEMT-J (QTR: 2013-00285)

[DESIGN RESOURCES](#)

- HMC681A Material Declaration
- PCN-PDN Information
- Quality And Reliability
- Symbols and Footprints

[DISCUSSIONS](#)

View all HMC681A EngineerZone Discussions.

[SAMPLE AND BUY](#)

Visit the product page to see pricing options.

[TECHNICAL SUPPORT](#)

Submit a technical question or find your regional support number.

[DOCUMENT FEEDBACK](#)

Submit feedback for this data sheet.

This page is dynamically generated by Analog Devices, Inc., and inserted into this data sheet. A dynamic change to the content on this page will not trigger a change to either the revision number or the content of the product data sheet. This dynamic page may be frequently modified.



0.5 dB LSB GaAs MMIC 6-BIT DIGITAL VARIABLE GAIN AMPLIFIER w/ SERIAL CONTROL, DC - 1 GHz

50 to 350 MHz Tuning

Gain vs. Frequency

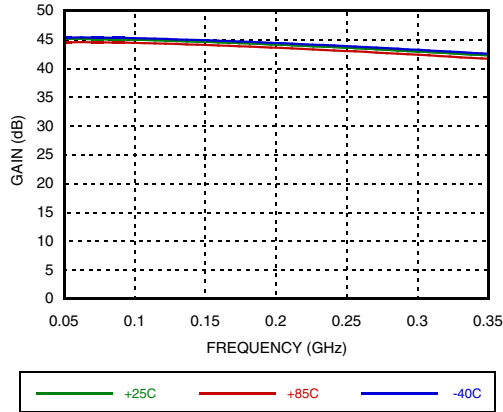

Relative Gain Setting

(Referenced to Maximum Gain State)
(Only Major States are Shown)

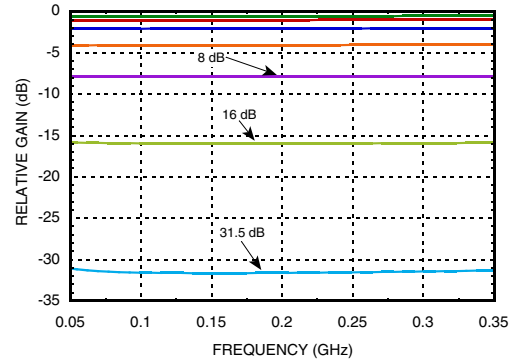

Input Return Loss

(Only Major States are Shown)

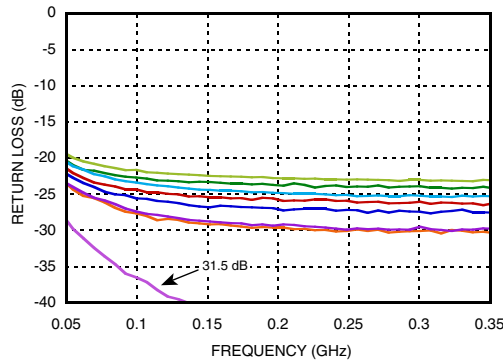

Output Return Loss

(Only Major States are Shown)

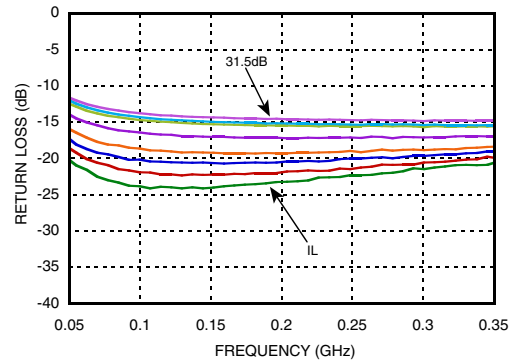

Bit Error vs. Frequency

(Only Major States are Shown)

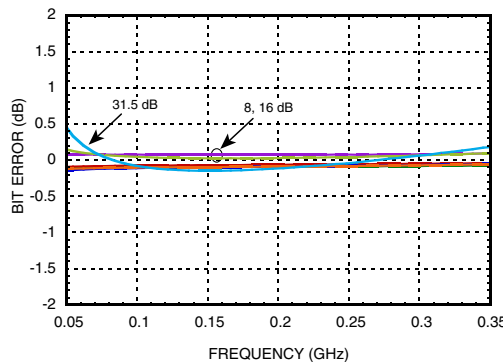

Bit Error vs. Relative Gain Setting

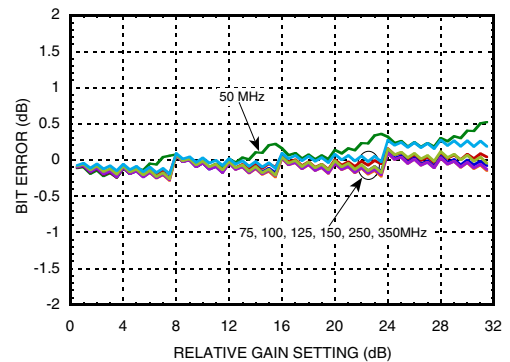

Information furnished by Analog Devices is believed to be accurate and reliable. However, no responsibility is assumed by Analog Devices for its use, nor for any infringements of patents or other rights of third parties that may result from its use. Specifications subject to change without notice. No license is granted by implication or otherwise under any patent or patent rights of Analog Devices. Trademarks and registered trademarks are the property of their respective owners.

For price, delivery, and to place orders: Analog Devices, Inc., One Technology Way, P.O. Box 9106, Norwood, MA 02062-9106 Phone: 781-329-4700 • Order online at www.analog.com Application Support: Phone: 1-800-ANALOG-D



**0.5 dB LSB GaAs MMIC 6-BIT DIGITAL VARIABLE GAIN
AMPLIFIER w/ SERIAL CONTROL, DC - 1 GHz**

50 to 350 MHz Tuning

Relative Phase vs. Frequency
(Only Major States are Shown)

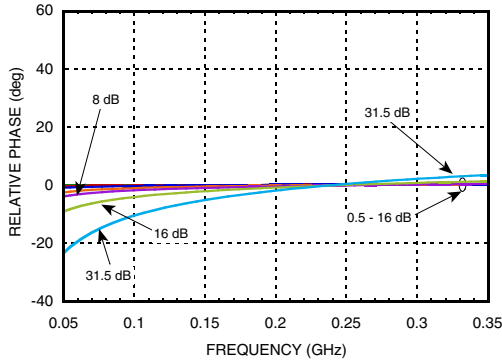

Step Error vs. Frequency
(Only Major States are Shown)

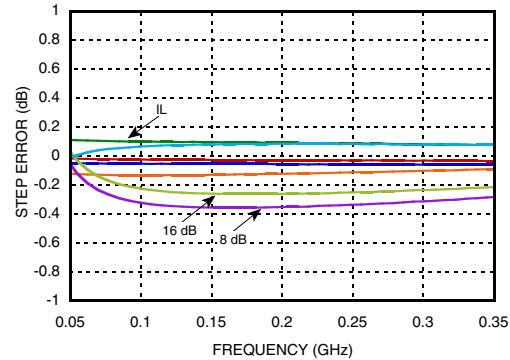

Output P1dB
(Major States shown are IL through 16 dB)

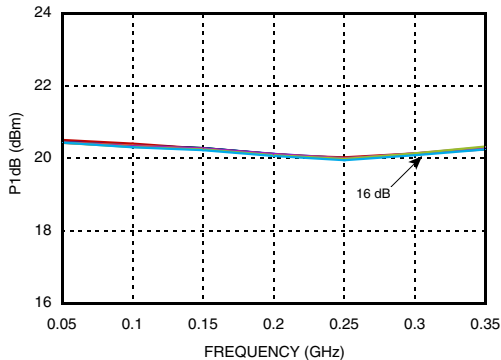

Output IP3 @ 5 dBm Output Power per Tone
(Major States shown are IL through 16 dB)

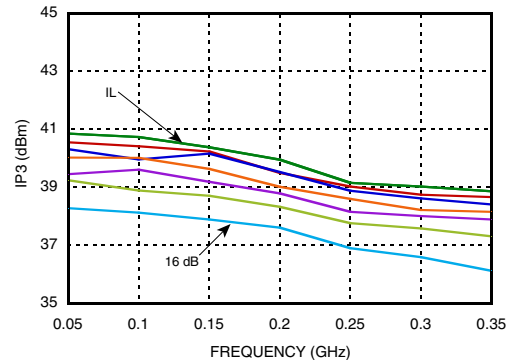

Information furnished by Analog Devices is believed to be accurate and reliable. However, no responsibility is assumed by Analog Devices for its use, nor for any infringements of patents or other rights of third parties that may result from its use. Specifications subject to change without notice. No license is granted by implication or otherwise under any patent or patent rights of Analog Devices. Trademarks and registered trademarks are the property of their respective owners.

For price, delivery, and to place orders: Analog Devices, Inc., One Technology Way, P.O. Box 9106, Norwood, MA 02062-9106 Phone: 781-329-4700 • Order online at www.analog.com Application Support: Phone: 1-800-ANALOG-D



**0.5 dB LSB GaAs MMIC 6-BIT DIGITAL VARIABLE GAIN
AMPLIFIER w/ SERIAL CONTROL, DC - 1 GHz**
350 to 1000 MHz Tuning

Gain vs. Frequency

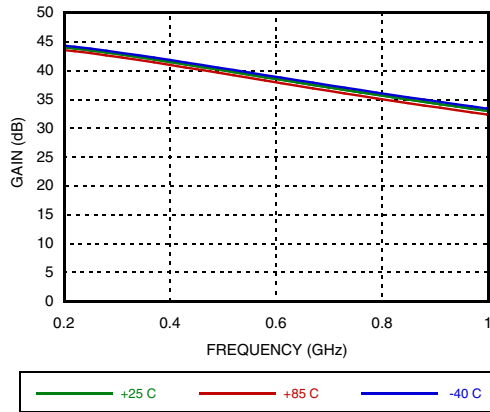

Relative Gain Setting

(Referenced to Maximum Gain State)
(Only Major States are Shown)

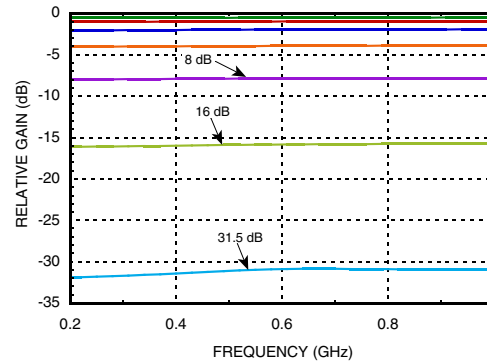

Input Return Loss

(Only Major States are Shown)

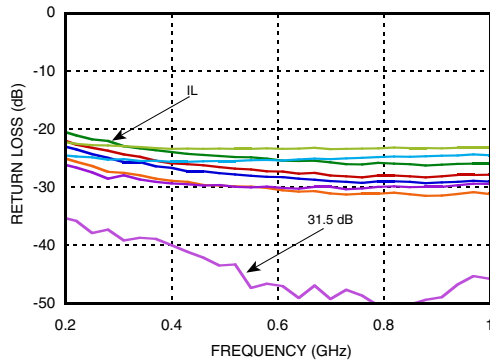

Output Return Loss

(Only Major States are Shown)

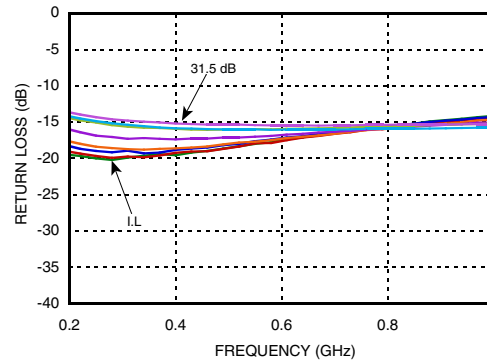

Bit Error vs. Frequency

(Only Major States are Shown)

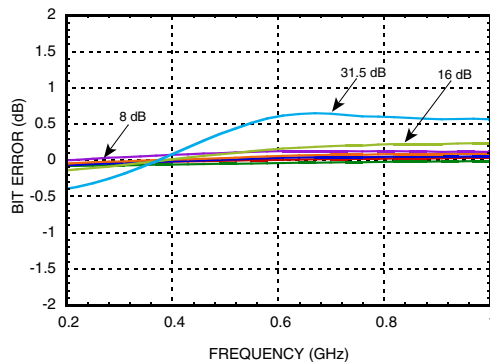

Bit Error vs. Relative Gain Setting

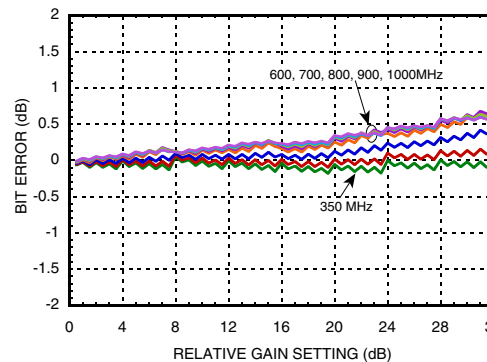

Information furnished by Analog Devices is believed to be accurate and reliable. However, no responsibility is assumed by Analog Devices for its use, nor for any infringements of patents or other rights of third parties that may result from its use. Specifications subject to change without notice. No license is granted by implication or otherwise under any patent or patent rights of Analog Devices. Trademarks and registered trademarks are the property of their respective owners.

For price, delivery, and to place orders: Analog Devices, Inc., One Technology Way, P.O. Box 9106, Norwood, MA 02062-9106 Phone: 781-329-4700 • Order online at www.analog.com Application Support: Phone: 1-800-ANALOG-D



0.5 dB LSB GaAs MMIC 6-BIT DIGITAL VARIABLE GAIN AMPLIFIER w/ SERIAL CONTROL, DC - 1 GHz
350 to 1000 MHz Tuning

VARIABLE GAIN AMPLIFIERS - DIGITAL - SMT

Relative Phase vs. Frequency
 (Only Major States are Shown)

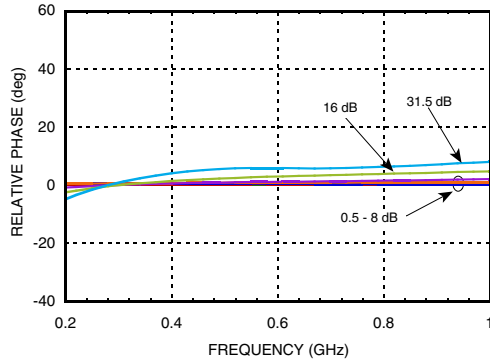

Step Error vs. Frequency
 (Only Major States are Shown)

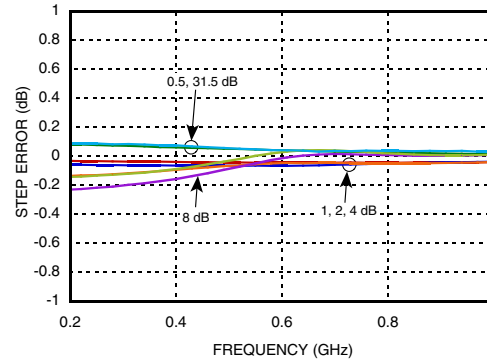

Output P1dB
 (Major States shown are IL through 16 dB)

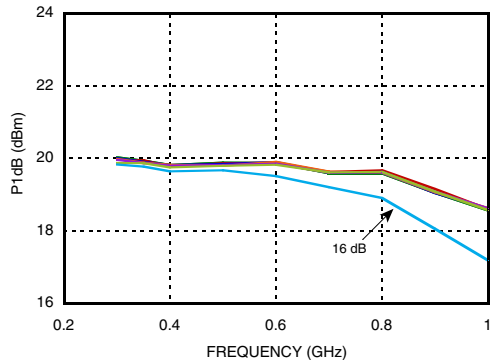

Output IP3 @ 5 dBm Output Power per Tone
 (Major States shown are IL through 16 dB)

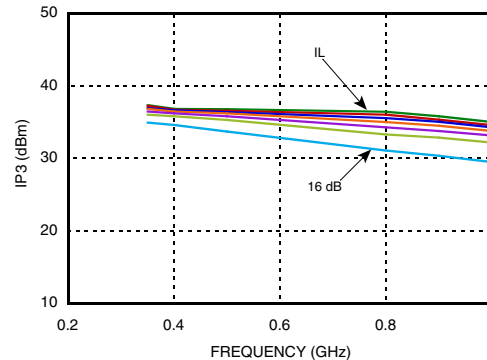

Power-Up States

If LE is set to logic LOW at power-up, the logic state of PUP1 and PUP2 determines the power-up state of the part per PUP truth table. The attenuator latches in the desired power-up state approximately 200 ms after power-up.

Power-On Sequence

The ideal power-up sequence is: GND, Vdd, digital inputs, RF inputs. The relative order of the digital inputs are not important as long as they are powered after Vdd / GND

PUP Truth Table

LE	PUP1	PUP2	Relative Gain Setting
0	0	0	-31.5
0	1	0	-24
0	0	1	-16
0	1	1	Insertion Loss

Information furnished by Analog Devices is believed to be accurate and reliable. However, no responsibility is assumed by Analog Devices for its use, nor for any infringements of patents or other rights of third parties that may result from its use. Specifications subject to change without notice. No license is granted by implication or otherwise under any patent or patent rights of Analog Devices. Trademarks and registered trademarks are the property of their respective owners.

For price, delivery, and to place orders: Analog Devices, Inc., One Technology Way, P.O. Box 9106, Norwood, MA 02062-9106 Phone: 781-329-4700 • Order online at www.analog.com Application Support: Phone: 1-800-ANALOG-D

0.5 dB LSB GaAs MMIC 6-BIT DIGITAL VARIABLE GAIN AMPLIFIER w/ SERIAL CONTROL, DC - 1 GHz



Serial Control Interface

The HMC681ALP5E contains a 3-wire SPI compatible digital interface (SERIN, CLK, LE). It is activated when P/S is kept high. The 6-bit serial word must be loaded MSB first. The positive-edge sensitive CLK and LE requires clean transitions. If mechanical switches were used, sufficient debouncing should be provided. When LE is high, 6-bit data in the serial input register is transferred to the attenuator. When LE is high CLK is masked to prevent data transition during output loading.

For all modes of operations, gain will remain constant while LE is kept low.

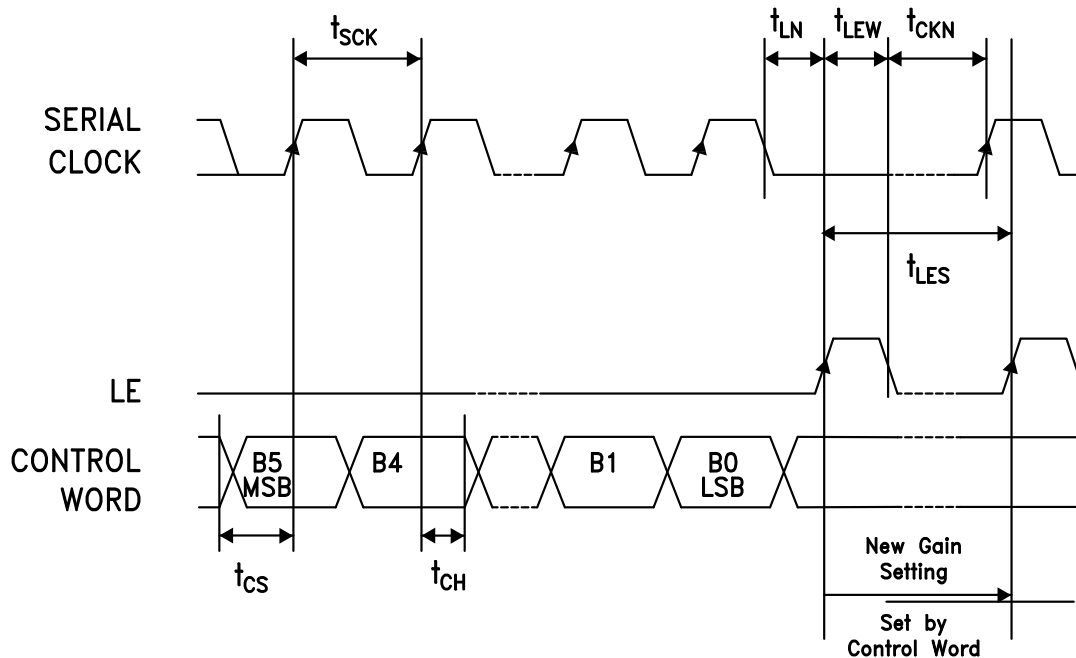

Truth Table

Parameter	Typ.
Min. serial period, t_{SCK}	100 ns
Control set-up time, t_{CS}	20 ns
Control hold-time, t_{CH}	20 ns
LE setup-time, t_{LN}	10 ns
Min. LE pulse width, t_{LEW}	10 ns
Min LE pulse spacing, t_{LES}	630 ns
Serial clock hold-time from LE, t_{CKN}	10 ns
Hold Time, t_{PH}	0 ns
Latch Enable Minimum Width, t_{LEN}	10 ns
Setup Time, t_{PS}	2 ns

Serial Word						Relative Gain Setting
B5 16 dB	B4 8dB	B3 4 dB	B2 2 dB	B1 1 dB	B0 0.5 dB	
High	High	High	High	High	High	Reference 0 dB
High	High	High	High	High	Low	-0.5 dB
High	High	High	High	Low	High	-1 dB
High	High	High	Low	High	High	-2 dB
High	High	Low	High	High	High	-4 dB
High	Low	High	High	High	High	-8 dB
Low	High	High	High	High	High	-16 dB
Low	Low	Low	Low	Low	Low	-31.5 dB

Any combination of the above states will provide a relative gain setting approximately equal to the sum of the bits selected.

**0.5 dB LSB GaAs MMIC 6-BIT DIGITAL VARIABLE GAIN
AMPLIFIER w/ SERIAL CONTROL, DC - 1 GHz**
Absolute Maximum Ratings

RF Input Power ^[1] (At Max Gain Setting)	-10.5 dBm (T = +85 °C)
Digital Inputs (Reset, Shift Clock, Latch Enable & Serial Input)	-0.5 to Vdd +0.5V
Bias Voltage (Vdd)	5.5V
Collector Bias Voltage (Vcc)	5.5V
Channel/Junction Temperature	150 °C
Continuous Pdiss (T = 85 °C) (derate 18.2 mW/°C above 85 °C) ^[2]	1.18 W
Thermal Resistance ^[3]	55 °C/W
Storage Temperature	-65 to +150 °C
Operating Temperature	-40 to +85 °C

[1] The Max RF Input Power Rating will increase by 0.5 dB for every 0.5 dB reduction in gain to a maximum RF Input Power of 10 dBm.

[2] This value is the total power dissipation in the amplifier.

[3] This is the thermal resistance for the amplifier.

Bias Voltage

Vdd (V)	Idd (Typ.) (mA)	
+5	2.5	
Vs (V)	Is ₁ (mA)	Is ₂ (mA)
+5	91	91

Control Voltage Table

State	Vdd = +3V	Vdd = +5V
Low	0 to 0.5V @ <1 μA	0 to 0.8V @ <1 μA
High	2 to 3V @ <1 μA	2 to 5V @ <1 μA



**ELECTROSTATIC SENSITIVE DEVICE
OBSERVE HANDLING PRECAUTIONS**



**0.5 dB LSB GaAs MMIC 6-BIT DIGITAL VARIABLE GAIN
AMPLIFIER w/ SERIAL CONTROL, DC - 1 GHz**

Outline Drawing

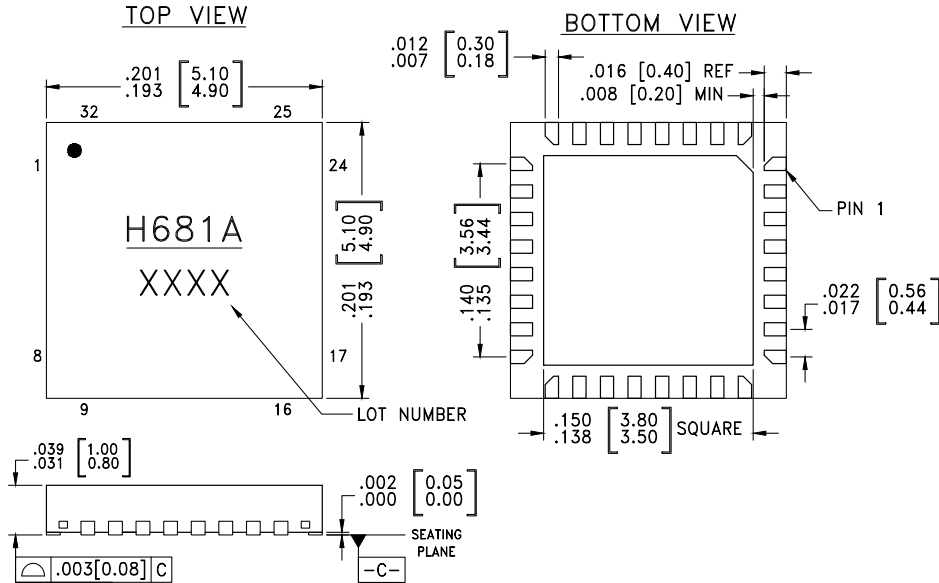

NOTES:

1. LEADFRAME MATERIAL: COPPER ALLOY
2. DIMENSIONS ARE IN INCHES [MILLIMETERS]
3. LEAD SPACING TOLERANCE IS NON-CUMULATIVE.
4. PAD BURR LENGTH SHALL BE 0.15mm MAXIMUM.
PAD BURR HEIGHT SHALL BE 0.05mm MAXIMUM.
5. PACKAGE WARP SHALL NOT EXCEED 0.05mm.
6. ALL GROUND LEADS AND GROUND PADDLE MUST BE SOLDERED TO PCB RF GROUND.
7. REFER TO HITTITE APPLICATION NOTE FOR SUGGESTED LAND PATTERN.



Package Information

Part Number	Package Body Material	Lead Finish	MSL Rating	Package Marking ^[2]
HMC681ALP5E	RoHS-compliant Low Stress Injection Molded Plastic	100% matte Sn	MSL1 ^[1]	H681A XXXX

[1] Max peak reflow temperature of 260 °C

[2] 4-Digit lot number XXXX

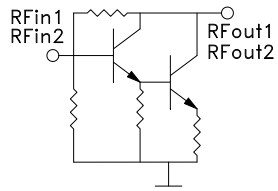
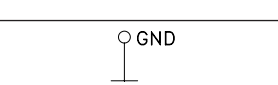
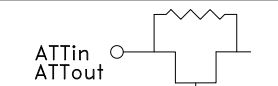

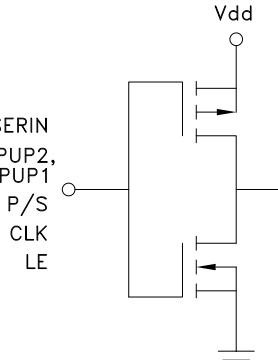
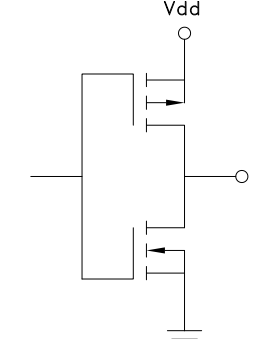
**0.5 dB LSB GaAs MMIC 6-BIT DIGITAL VARIABLE GAIN
AMPLIFIER w/ SERIAL CONTROL, DC - 1 GHz**
Pin Descriptions

Pin Number	Function	Description	Interface Schematic
1, 5, 9, 14, 16, 23, 28	N/C	The pins are not connected internally; however, all data shown herein was measured with these pins connected to RF/DC ground externally.	
2, 20	RFin1,RFin2	This pin is DC coupled. An off chip DC blocking capacitor is required.	
4, 22	RFout1, RFout2	RF output and DC bias (Vcc) for the output stage of the amplifiers. Amplifier bias provided via external bias tee as shown in application circuit.	
3, 7, 18, 21	GND	These pins and package bottom must be connected to RF/DC ground.	
6, 19	ATTin, ATTout	These pins are DC coupled and matched to 50 Ohms. Blocking capacitors are required. Select value based on lowest frequency of operation.	
8, 10, 11, 12, 13, 15, 17	ACG1, ACG2, ACG3, ACG4, ACG5, ACG6, ACG7	External capacitors to ground is required. Select value for lowest frequency of operation. Place capacitor as close to pins as possible.	
24	SEROUT	Serial input data delayed by 6 clock cycles.	
25, 26	PUP2, PUP1	Refer to truth tables and serial control interface diagram.	
30	CLK		
31	SERIN		
32	LE		
29	P/S		Apply +5V for normal operation.
27	Vdd	Supply voltage	

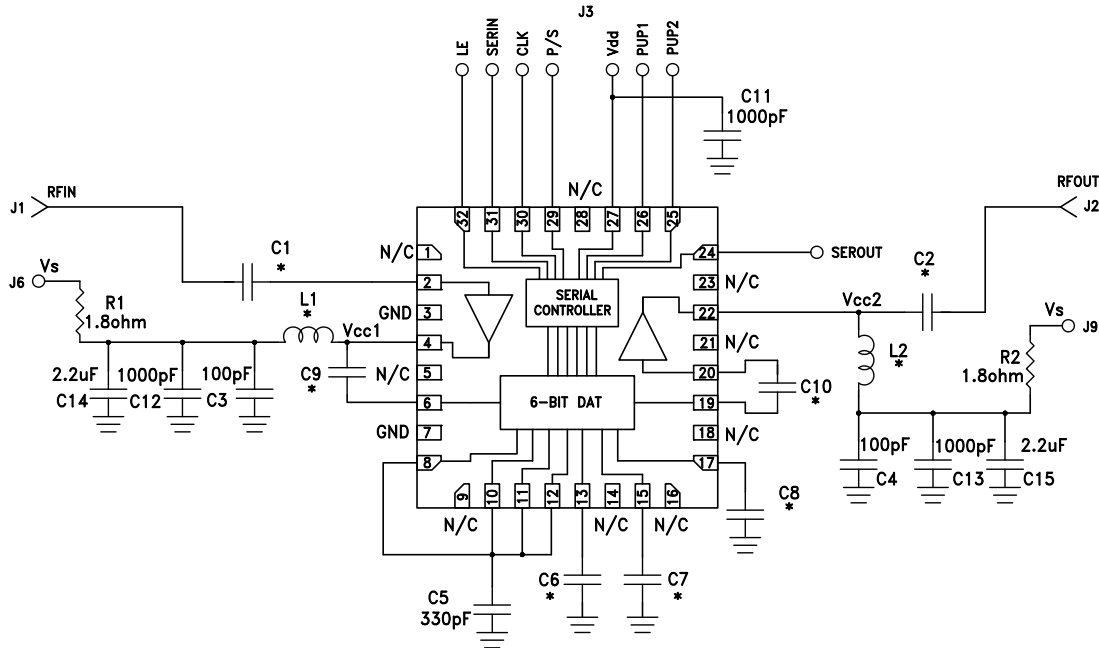

0.5 dB LSB GaAs MMIC 6-BIT DIGITAL VARIABLE GAIN AMPLIFIER w/ SERIAL CONTROL, DC - 1 GHz

Application Circuit



Components for Selected Frequencies

Tuned Frequency	50 - 350 MHz	350 - 1000 MHz
Evaluation PCB	119171-HMC681ALP5	123115-HMC681ALP5
C1, C2, C9, C10	3300 pF	100 pF
C6 - C8	330 pF	100 pF
L1, L2	560 nH	270 nH

Information furnished by Analog Devices is believed to be accurate and reliable. However, no responsibility is assumed by Analog Devices for its use, nor for any infringements of patents or other rights of third parties that may result from its use. Specifications subject to change without notice. No license is granted by implication or otherwise under any patent or patent rights of Analog Devices. Trademarks and registered trademarks are the property of their respective owners.

For price, delivery, and to place orders: Analog Devices, Inc., One Technology Way, P.O. Box 9106, Norwood, MA 02062-9106 Phone: 781-329-4700 • Order online at www.analog.com Application Support: Phone: 1-800-ANALOG-D

0.5 dB LSB GaAs MMIC 6-BIT DIGITAL VARIABLE GAIN AMPLIFIER w/ SERIAL CONTROL, DC - 1 GHz



Evaluation PCB

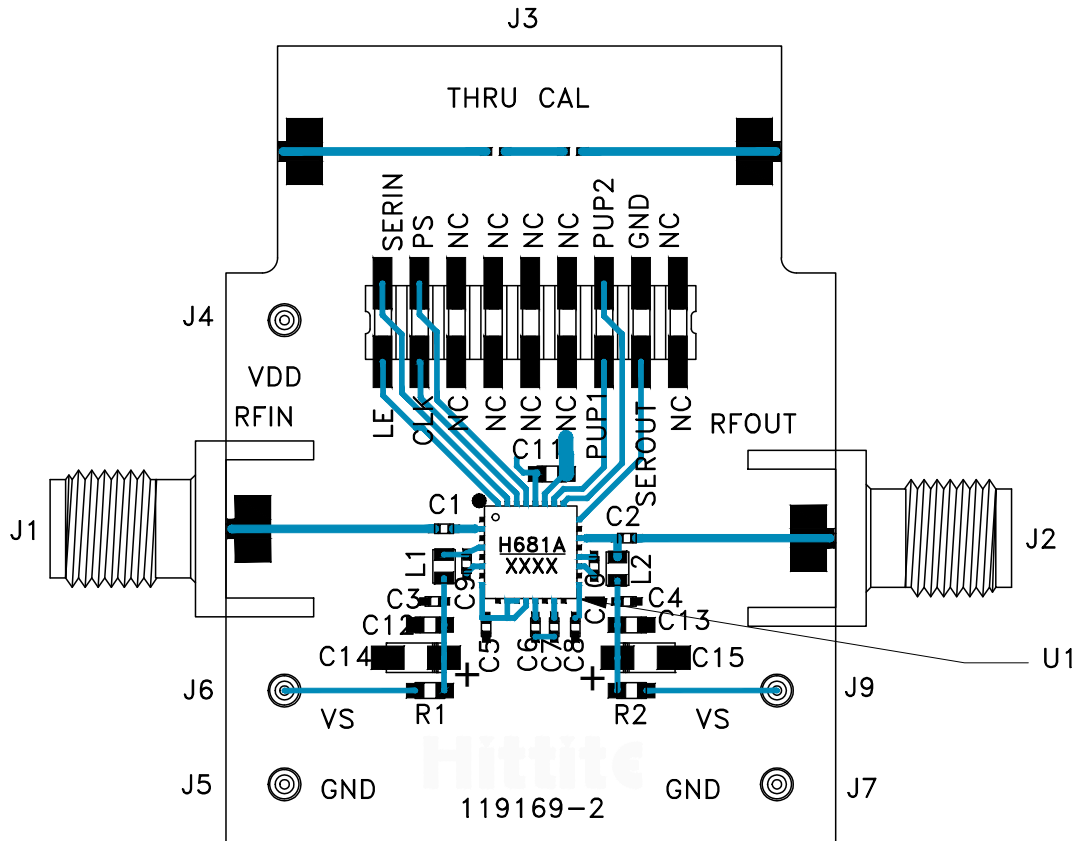

List of Materials for Evaluation PCB [1]

Item	Description
J1 - J2	PCB Mount SMA Connector
J3	18 Pin DC Connector
J4 - J7, J9	DC Pin
C1, C2, C9, C10	Capacitor, 0402 Pkg. [1]
C3 - C5	100 pF Capacitor, 0402 Pkg.
C6 - C8	Capacitor, 0402 Pkg. [1]
C11 - C13	1000 pF Capacitor, 0402 Pkg.
C14, C15	2.2 μF Capacitor, CASE A Pkg.
R1, R2	1.8 Ohm Resistor, 0603 Pkg.
L1, L2	Inductor, 0603 Pkg. [1]
U1	HMC681ALP5E Variable Gain Amplifier
PCB [2]	119169 Evaluation PCB

[1] Please reference "Components for Selected Frequencies" table.

[2] Circuit Board Material: Arlon 25FR

The circuit board used in the application should use RF circuit design techniques. Signal lines should have 50 Ohm impedance while the package ground leads and exposed paddle should be connected directly to the ground plane similar to that shown. A sufficient number of via holes should be used to connect the top and bottom ground planes. The evaluation circuit board shown is available from Hittite upon request. Refer to "Components for Selected Frequencies" table for part number.