

Dual P-Channel 20-V (D-S) MOSFET

PRODUCT SUMMARY		
V_{DS} (V)	$R_{DS(on)}$ (Ω)	I_D (A)
- 20	0.051 at $V_{GS} = - 4.5$ V	- 5.7
	0.067 at $V_{GS} = - 2.5$ V	- 5.0
	0.094 at $V_{GS} = - 1.8$ V	- 4.2

FEATURES

- Halogen-free Option Available
- TrenchFET[®] Power MOSFETS: 1.8 V Rated
- New Low Thermal Resistance PowerPAK[®] Package



RoHS
COMPLIANT

APPLICATIONS

- Portable
 - PA Switch
 - Battery Switch
 - Load Switch

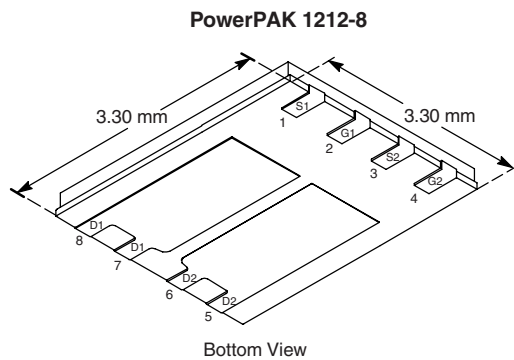

Ordering Information: Si7911DN-T1-E3 (Lead (Pb)-free)
Si7911DN-T1-GE3 (Lead (Pb)-free and Halogen-free)

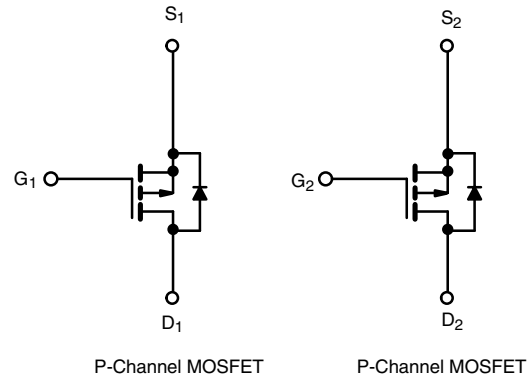

ABSOLUTE MAXIMUM RATINGS $T_A = 25$ °C, unless otherwise noted					
Parameter	Symbol	10 s	Steady State	Unit	
Drain-Source Voltage	V_{DS}	- 20		V	
Gate-Source Voltage	V_{GS}	± 8			
Continuous Drain Current ($T_J = 150$ °C) ^a	I_D	$T_A = 25$ °C	- 5.7	- 4.2	A
		$T_A = 85$ °C	- 4.1	- 3.0	
Pulsed Drain Current	I_{DM}	- 20		A	
Continuous Source Current (Diode Conduction) ^a	I_S	- 2.1	- 1.1		
Maximum Power Dissipation ^a	P_D	$T_A = 25$ °C	2.5	1.3	W
		$T_A = 85$ °C	1.3	0.85	
Operating Junction and Storage Temperature Range	T_J, T_{stg}	- 55 to 150		°C	
Soldering Recommendations ^{b, c}		260			

THERMAL RESISTANCE RATINGS					
Parameter	Symbol	Typical	Maximum	Unit	
Maximum Junction-to-Ambient ^a	R_{thJA}	$t \leq 10$ s	40	50	°C/W
		Steady State	75	94	
Maximum Junction-to-Case	R_{thJC}	5.6	7		

Notes:

- Surface Mounted on 1" x 1" FR4 board.
- See Solder Profile (<http://www.vishay.com/ppg?73257>). The PowerPAK 1212-8 is a leadless package. The end of the lead terminal is exposed copper (not plated) as a result of the singulation process in manufacturing. A solder fillet at the exposed copper tip cannot be guaranteed and is not required to ensure adequate bottom side solder interconnection.
- Rework Conditions: manual soldering with a soldering iron is not recommended for leadless components.

SPECIFICATIONS $T_J = 25\text{ }^\circ\text{C}$, unless otherwise noted						
Parameter	Symbol	Test Conditions	Min.	Typ.	Max.	Unit
Static						
Gate Threshold Voltage	$V_{GS(th)}$	$V_{DS} = V_{GS}, I_D = -250\ \mu\text{A}$	-0.40		-1.0	V
Gate-Body Leakage	I_{GSS}	$V_{DS} = 0\ \text{V}, V_{GS} = \pm 8\ \text{V}$			± 100	nA
Zero Gate Voltage Drain Current	I_{DSS}	$V_{DS} = -20\ \text{V}, V_{GS} = 0\ \text{V}$			-1	μA
		$V_{DS} = -20\ \text{V}, V_{GS} = 0\ \text{V}, T_J = 85\text{ }^\circ\text{C}$			-5	
On-State Drain Current ^a	$I_{D(on)}$	$V_{DS} \leq -5\ \text{V}, V_{GS} = -4.5\ \text{V}$	-20			A
Drain-Source On-State Resistance ^a	$R_{DS(on)}$	$V_{GS} = -4.5\ \text{V}, I_D = -5.7\ \text{A}$		0.040	0.051	Ω
		$V_{GS} = -2.5\ \text{V}, I_D = -5.0\ \text{A}$		0.054	0.067	
		$V_{GS} = -1.8\ \text{V}, I_D = -1.1\ \text{A}$		0.075	0.094	
Forward Transconductance ^a	g_{fs}	$V_{DS} = -6\ \text{V}, I_D = -5.7\ \text{A}$		14		S
Diode Forward Voltage ^a	V_{SD}	$I_S = -2.3\ \text{A}, V_{GS} = 0\ \text{V}$		-0.8	-1.2	V
Dynamic^b						
Total Gate Charge	Q_g	$V_{DS} = -6\ \text{V}, V_{GS} = -4.5\ \text{V}, I_D = -5.7\ \text{A}$		9.5	15	nC
Gate-Source Charge	Q_{gs}			1.6		
Gate-Drain Charge	Q_{gd}			2.5		
Gate Resistance	R_g			7.2		Ω
Turn-On Delay Time	$t_{d(on)}$	$V_{DD} = -10\ \text{V}, R_L = 10\ \Omega$ $I_D \cong -1\ \text{A}, V_{GEN} = -4.5\ \text{V}, R_G = 6\ \Omega$		20	30	ns
Rise Time	t_r			35	55	
Turn-Off Delay Time	$t_{d(off)}$			70	105	
Fall Time	t_f			40	60	
Source-Drain Reverse Recovery Time	t_{rr}	$I_F = -2.1\ \text{A}, di/dt = 100\ \text{A}/\mu\text{s}$		25	50	

Notes:

- a. Pulse test; pulse width $\leq 300\ \mu\text{s}$, duty cycle $\leq 2\%$.
b. Guaranteed by design, not subject to production testing.

Stresses beyond those listed under "Absolute Maximum Ratings" may cause permanent damage to the device. These are stress ratings only, and functional operation of the device at these or any other conditions beyond those indicated in the operational sections of the specifications is not implied. Exposure to absolute maximum rating conditions for extended periods may affect device reliability.

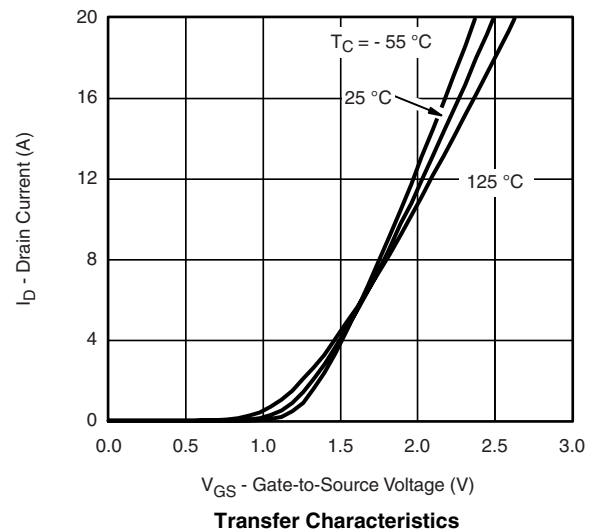
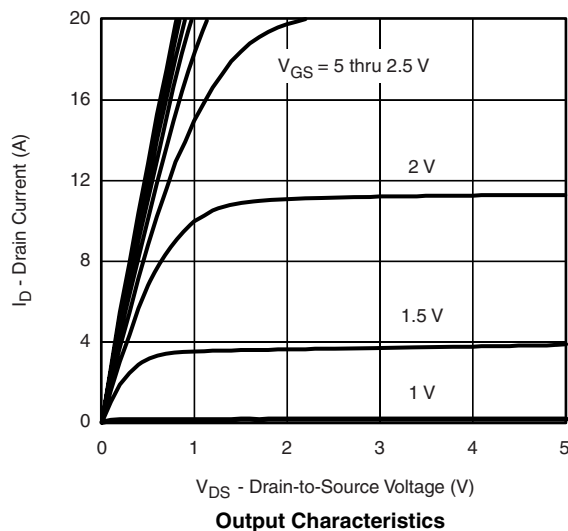
TYPICAL CHARACTERISTICS $T_A = 25\text{ }^\circ\text{C}$, unless otherwise noted

TYPICAL CHARACTERISTICS $T_A = 25\text{ }^\circ\text{C}$, unless otherwise noted

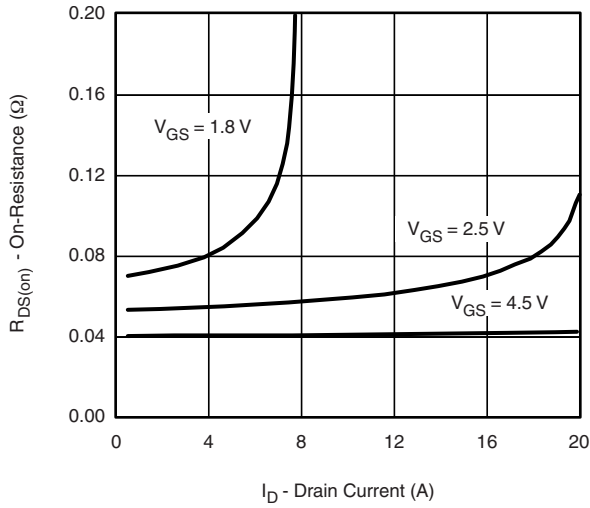

On-Resistance vs. Drain Current

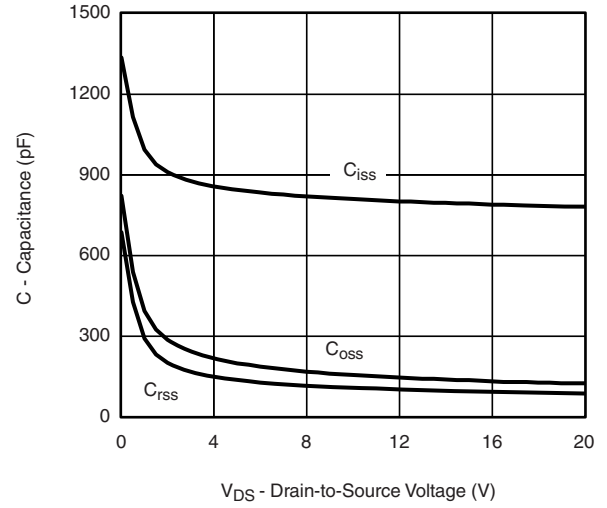

Capacitance

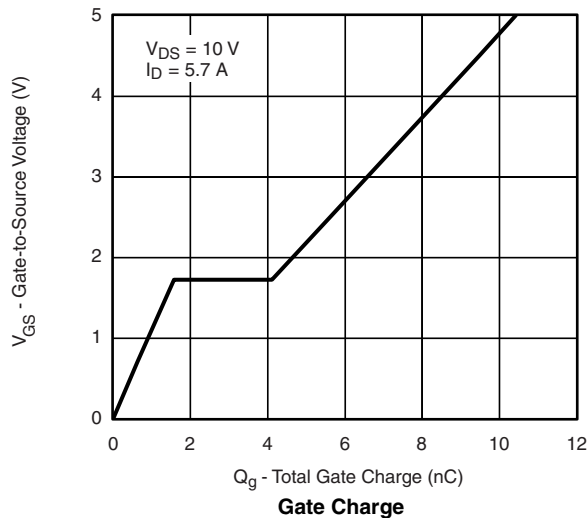

Gate Charge

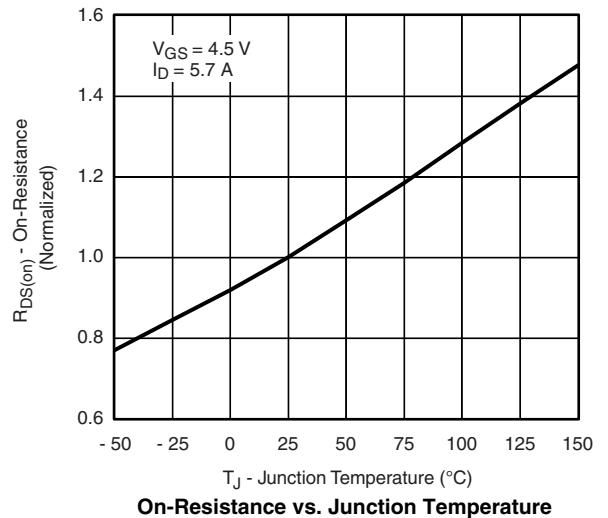

On-Resistance vs. Junction Temperature

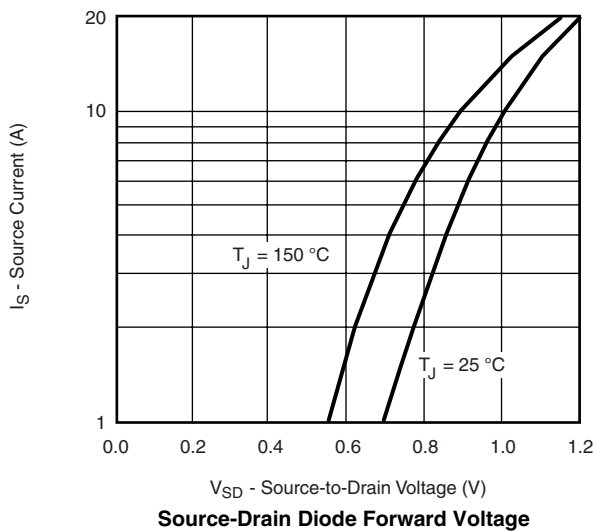

Source-Drain Diode Forward Voltage

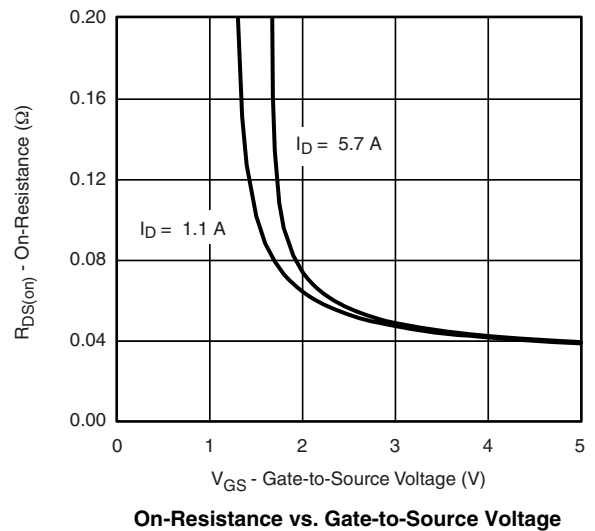

On-Resistance vs. Gate-to-Source Voltage

TYPICAL CHARACTERISTICS $T_A = 25\text{ }^\circ\text{C}$, unless otherwise noted

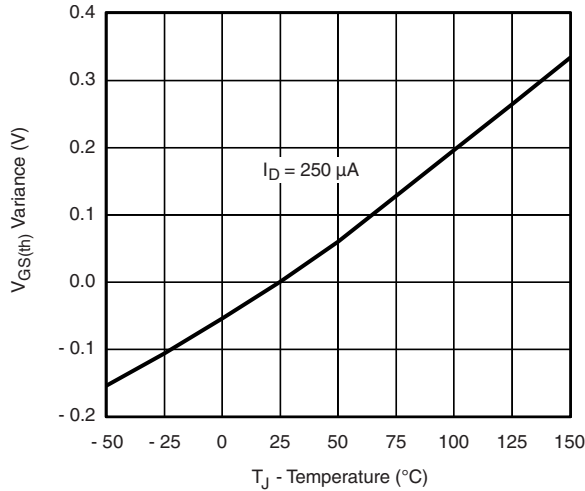

Threshold Voltage

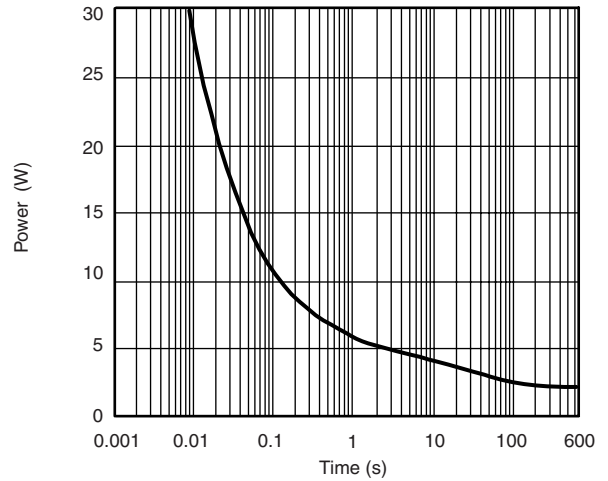

Single Pulse Power, Junction-to-Ambient

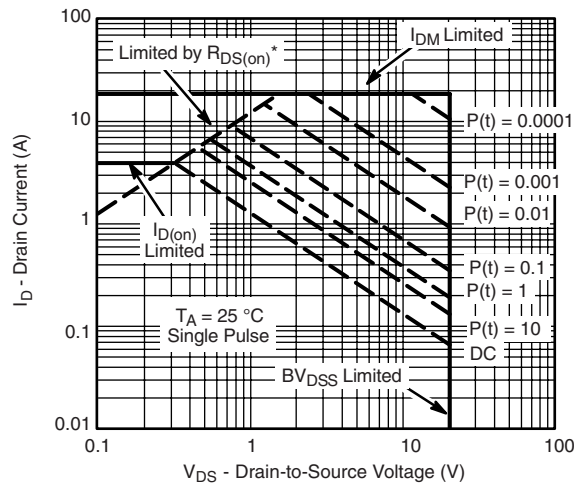

Safe Operating Area, Junction-to-Ambient

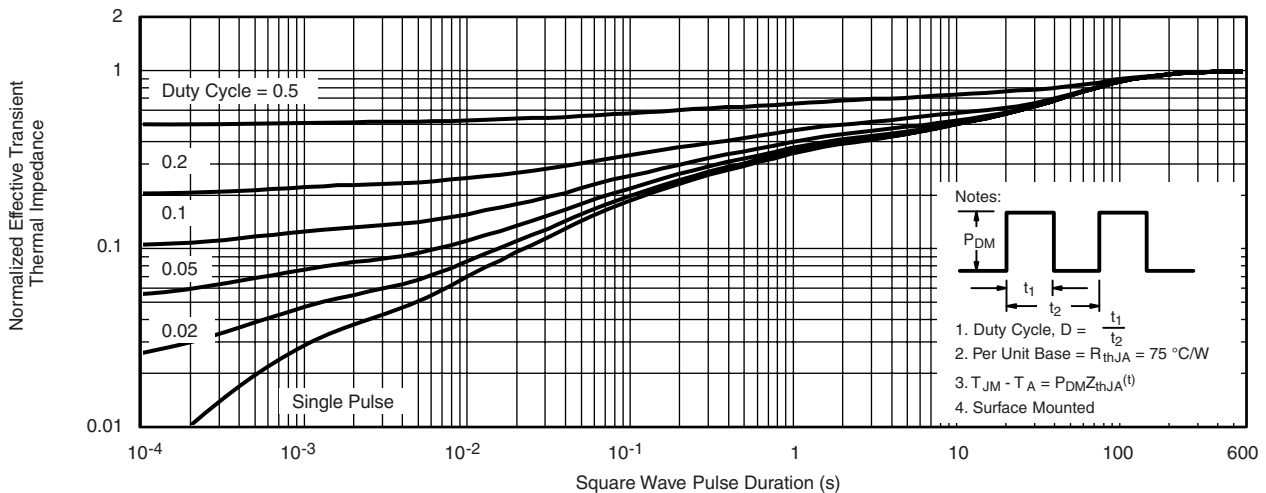

Normalized Thermal Transient Impedance, Junction-to-Ambient

TYPICAL CHARACTERISTICS $T_A = 25\text{ }^\circ\text{C}$, unless otherwise noted

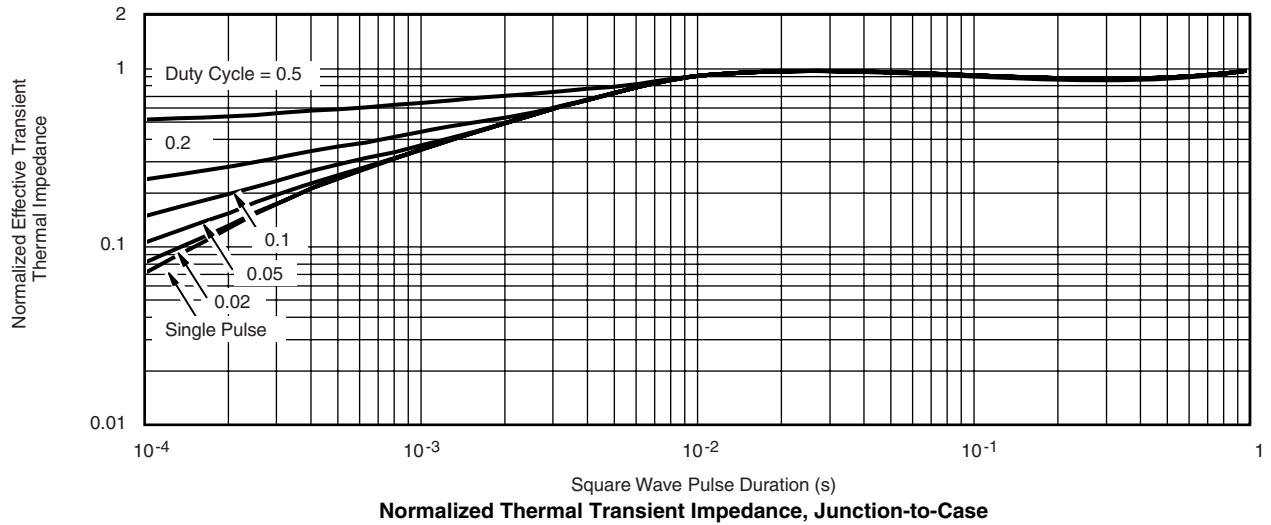

Vishay Siliconix maintains worldwide manufacturing capability. Products may be manufactured at one of several qualified locations. Reliability data for Silicon Technology and Package Reliability represent a composite of all qualified locations. For related documents such as package/tape drawings, part marking, and reliability data, see <http://www.vishay.com/ppg?72340>.



Disclaimer

ALL PRODUCT, PRODUCT SPECIFICATIONS AND DATA ARE SUBJECT TO CHANGE WITHOUT NOTICE TO IMPROVE RELIABILITY, FUNCTION OR DESIGN OR OTHERWISE.

Vishay Intertechnology, Inc., its affiliates, agents, and employees, and all persons acting on its or their behalf (collectively, "Vishay"), disclaim any and all liability for any errors, inaccuracies or incompleteness contained in any datasheet or in any other disclosure relating to any product.

Vishay makes no warranty, representation or guarantee regarding the suitability of the products for any particular purpose or the continuing production of any product. To the maximum extent permitted by applicable law, Vishay disclaims (i) any and all liability arising out of the application or use of any product, (ii) any and all liability, including without limitation special, consequential or incidental damages, and (iii) any and all implied warranties, including warranties of fitness for particular purpose, non-infringement and merchantability.

Statements regarding the suitability of products for certain types of applications are based on Vishay's knowledge of typical requirements that are often placed on Vishay products in generic applications. Such statements are not binding statements about the suitability of products for a particular application. It is the customer's responsibility to validate that a particular product with the properties described in the product specification is suitable for use in a particular application. Parameters provided in datasheets and / or specifications may vary in different applications and performance may vary over time. All operating parameters, including typical parameters, must be validated for each customer application by the customer's technical experts. Product specifications do not expand or otherwise modify Vishay's terms and conditions of purchase, including but not limited to the warranty expressed therein.

Hyperlinks included in this datasheet may direct users to third-party websites. These links are provided as a convenience and for informational purposes only. Inclusion of these hyperlinks does not constitute an endorsement or an approval by Vishay of any of the products, services or opinions of the corporation, organization or individual associated with the third-party website. Vishay disclaims any and all liability and bears no responsibility for the accuracy, legality or content of the third-party website or for that of subsequent links.

Except as expressly indicated in writing, Vishay products are not designed for use in medical, life-saving, or life-sustaining applications or for any other application in which the failure of the Vishay product could result in personal injury or death. Customers using or selling Vishay products not expressly indicated for use in such applications do so at their own risk. Please contact authorized Vishay personnel to obtain written terms and conditions regarding products designed for such applications.

No license, express or implied, by estoppel or otherwise, to any intellectual property rights is granted by this document or by any conduct of Vishay. Product names and markings noted herein may be trademarks of their respective owners.