

DEBB33F471KC3B

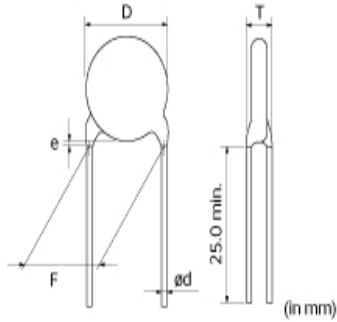

Appearance & Shape

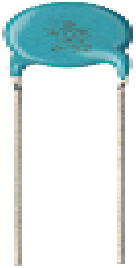

References

Packaging	Specifications	Standard Packing Quantity
B	Bulk(Bag)	250

Mass (typ.)	
1 piece	0.4g

Attention

- 1.This datasheet is downloaded from the website of Murata Manufacturing Co., Ltd. Therefore, it's specifications are subject to change or our products in it may be discontinued without advance notice. Please check with our sales representatives or product engineers before ordering.
- 2.This datasheet has only typical specifications because there is no space for detailed specifications. Therefore, please review our product specifications or consult the approval sheet for product specifications before ordering.

DEBB33F471KC3B



Specifications

L size or Outer diameter D	7.0mm max.
T size	6.0mm max.
Lead spacing F	7.5±1.0mm
Lead diameter d	0.6±0.05mm
Paint dripping e	3.0mm max.
Capacitance	470pF ±10%
Rated voltage	3150Vdc
Temperature characteristics	B(JIS)
Capacitance change rate	±10%
Temperature range of temperature characteristics	-25°C to 85°C
Operating Temperature Range	-25°C to 85°C

Attention

1.This datasheet is downloaded from the website of Murata Manufacturing Co., Ltd. Therefore, it's specifications are subject to change or our products in it may be discontinued without advance notice. Please check with our sales representatives or product engineers before ordering.

2.This datasheet has only typical specifications because there is no space for detailed specifications.

Therefore, please review our product specifications or consult the approval sheet for product specifications before ordering.