

2.2 MHz, 600mA Synchronous Step-Up DC/DC Converter and 100mA LDO

FEATURES

High Efficiency Step-Up DC/DC Converter and LDO

Step-Up

- V_{IN} : 0.68V to 5V, V_{OUT} : 1.5V to 5.25V
- I_{OUT} : 100mA at 3.3V, $V_{IN} > 0.8V$
- 2.2MHz Fixed Frequency Operation
- Synchronous Rectifier with Output Disconnect
- Burst Mode Operation (Pin Selectable)

Linear LDO Regulator

- V_{IN} : 1.8V to 5.5V, V_{OUT} : 0.6V to 5V
- I_{OUT} : 100mA
- 100mV Dropout Voltage at 50mA
- 24dB Ripple Rejection at f_{SW}

Combined

- Power Good Indicators
- Low-Battery Comparator
- 30 μ A I_Q
- Low Profile 3mm \times 3mm \times 0.75mm Package

APPLICATIONS

- Wireless Microphones
- Portable Medical instruments
- Noise Cancelling/Portable Headsets
- RF and Audio Power

DESCRIPTION

The LTC[®]3537 combines a high efficiency, 2.2MHz step-up DC/DC converter with an independent 100mA low dropout regulator (LDO). The step-up converter starts from an input voltage as low as 0.68V and contains an internal 0.4 Ω switch and a 0.6 Ω synchronous rectifier that disconnects from the output when disabled in shutdown.

A switching frequency of 2.2MHz minimizes solution footprint by allowing the use of tiny, low profile inductors and ceramic capacitors. The current mode PWM design is internally compensated, reducing external parts count. Fixed frequency switching is maintained until a light load current is sensed, at which point Burst Mode[®] operation is engaged to maximize efficiency. For low noise operation, Burst Mode Operation can be disabled. Anti-ring circuitry reduces EMI by damping the inductor in discontinuous mode. Additional features include a low shutdown current of under 1 μ A and thermal overload protection.

The integrated LDO regulator provides a very low noise, programmable low dropout supply.

LT, LT, LTC, LTM and Burst Mode are registered trademarks of Linear Technology Corporation. All other trademarks are the property of their respective owners.

TYPICAL APPLICATION

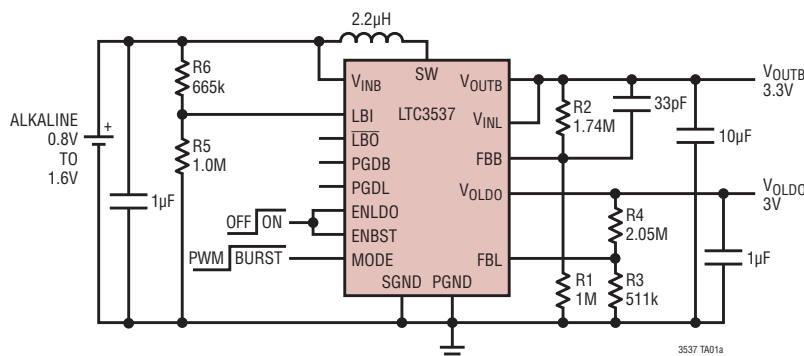

Efficiency and Power Loss
vs Load Current

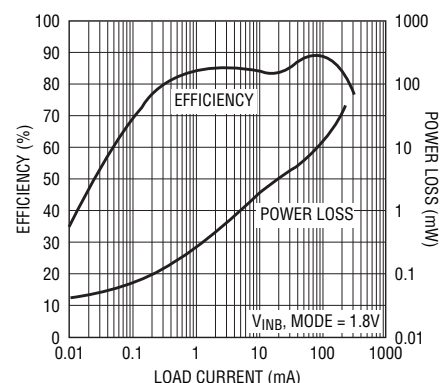

ABSOLUTE MAXIMUM RATINGS

(Note 1)

V_{INB} and V_{INL} Voltage.....	-0.3V to 6V
SW DC Voltage.....	-0.3V to 6V
SW Pulsed (<100ns) Voltage	-0.3V to 7V
FBB, FBL, PGDB, PGDL Voltage	-0.3V to 6V
MODE, ENBST, ENLDO Voltage	-0.3V to 6V
LBI and \overline{LBO} Voltage	-0.3V to 6V
V_{OUTB} , V_{OLDO}	-0.3V to 6V
Operating Temperature (Notes 2, 5).....	-40°C to 85°C
Junction Temperature	125°C
Storage Temperature Range.....	-65°C to 125°C

PIN CONFIGURATION

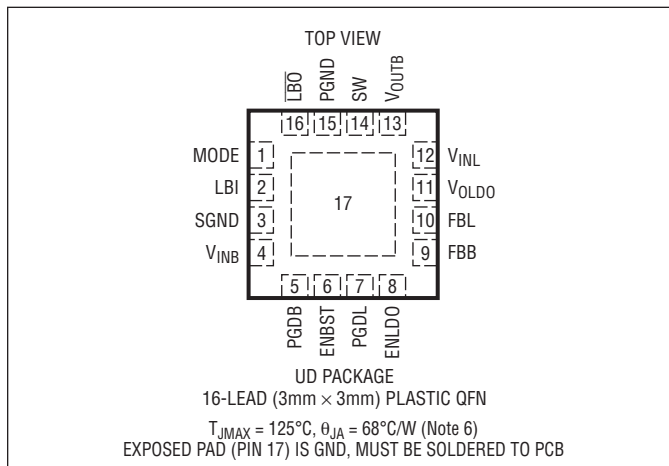

ORDER INFORMATION

LEAD FREE FINISH	TAPE AND REEL	PART MARKING	PACKAGE DESCRIPTION	TEMPERATURE RANGE
LTC3537EUD#PBF	LTC3537EUD#TRPBF	LDBD	16-Lead (3mm x 3mm) Plastic QFN	-40°C to 85°C

Consult LTC Marketing for parts specified with wider operating temperature ranges.

Consult LTC Marketing for information on non-standard lead based finish parts.

For more information on lead free part marking, go to: <http://www.linear.com/leadfree/>

For more information on tape and reel specifications, go to: <http://www.linear.com/tapeandreel/>

ELECTRICAL CHARACTERISTICS

The ● denotes the specifications which apply over the full operating temperature range, otherwise specifications are at $T_A = 25^{\circ}\text{C}$. $V_{INB} = 1.2\text{V}$, $V_{OUTB} = 3.3\text{V}$, unless otherwise noted.

SYMBOL	PARAMETER	CONDITIONS	MIN	TYP	MAX	UNITS
Boost Converter						
V_{INMIN}	Minimum Start-Up Voltage	$I_{LOAD} = 1\text{mA}$		0.68	0.8	V
V_{OUTB}	Output Voltage Range		● 1.5		5.25	V
V_{FBB}	Feedback Voltage		● 1.179	1.21	1.240	V
I_{FBB}	Feedback Input Current			1	50	nA
I_{QSHDN}	Quiescent Current - Shutdown	$V_{ENBST} = V_{ENLDO} = 0\text{V}$, Not Including SW Leakage, $V_{OUTB} = 0\text{V}$		0.02	1	μA
$I_{QACTIVE}$	Quiescent Current - Active	Measured on V_{OUTB} , Nonswitching, $MODE = 1.2\text{V}$, $V_{ENLDO} = 0\text{V}$		300	500	μA
I_{QBURST}	Quiescent Current - Burst	Measured on V_{OUTB} , $FBB > 1.24\text{V}$, $MODE = 1.2\text{V}$, $V_{ENLDO} = 0\text{V}$		15		μA
I_{NLEAK}	NMOS Switch Leakage Current	$V_{SW} = 5\text{V}$		0.1	5	μA
I_{PLEAK}	PMOS Switch Leakage Current	$V_{SW} = 5\text{V}$, $V_{OUTB} = 0\text{V}$		0.1	10	μA

ELECTRICAL CHARACTERISTICS

The ● denotes the specifications which apply over the full operating temperature range, otherwise specifications are at $T_A = 25^\circ\text{C}$. (Note 2) $V_{\text{INB}} = 1.2\text{V}$, $V_{\text{OUTB}} = 3.3\text{V}$, unless otherwise noted.

SYMBOL	PARAMETER	CONDITIONS	MIN	TYP	MAX	UNITS	
R_{NMOS}	NMOS Switch On Resistance	$V_{\text{OUTB}} = 1.8\text{V}$		0.8		Ω	
		$V_{\text{OUTB}} = 3.3\text{V}$		0.4		Ω	
		$V_{\text{OUTB}} = 5\text{V}$		0.3		Ω	
R_{PMOS}	PMOS Switch On Resistance	$V_{\text{OUTB}} = 1.8\text{V}$		1		Ω	
		$V_{\text{OUTB}} = 3.3\text{V}$		0.6		Ω	
		$V_{\text{OUTB}} = 5\text{V}$		0.4		Ω	
I_{LIM}	NMOS Current Limit	(Note 4)	●	600	750	mA	
t_{LIMDELAY}	Current Limit Delay Time to Output	(Note 3)		40		ns	
		Max Duty Cycle	$V_{\text{FBB}} = 1.15\text{V}$	●	87	92	%
		Min Duty Cycle	$V_{\text{FBB}} = 1.3\text{V}$	●		0	%
f_{SW}	Switching Frequency		●	2	2.2	2.4	MHz
V_{ENBSTH}	ENBST Input High Voltage			0.8		V	
V_{ENBSTL}	ENBST Input Low Voltage				0.3	V	
I_{ENBSTIN}	ENBST Input Current	$V_{\text{ENBST}} = 5.5\text{V}$		1.5		μA	
V_{MODEH}	MODE Input High Voltage			0.8		V	
V_{MODEL}	MODE Input Low Voltage				0.3	V	
I_{MODEIN}	MODE Input Current	$V_{\text{MODE}} = 5.5\text{V}$		1.5		μA	
t_{SS}	Soft-Start Time			0.5		ms	
V_{FBLBI}	LBI Feedback Voltage	Falling Threshold		530	553	575	mV
	LBI Hysteresis Voltage				35		mV
I_{LBIIN}	LBI Input Current	$V_{\text{LBI}} = 1\text{V}$		10	50	nA	
V_{LBOLOW}	$\overline{\text{LBO}}$ Voltage Low	$I_{\text{LBO}} = 5\text{mA}$		200		mV	
I_{LBOLEAK}	$\overline{\text{LBO}}$ Leakage Current	$V_{\text{LBO}} = 5.5\text{V}$		0.01	1	μA	
V_{PGDBLOW}	PGDB Voltage Low	$I_{\text{PGDB}} = 5\text{mA}$		200		mV	
I_{PGDBLEAK}	PGDB Leakage Current	$V_{\text{PGDB}} = 5.5\text{V}$		0.01	1	μA	
		PGDB Trip Point Voltage	V_{FBB} Rising		94		% V_{OUTB}
		PGDB Hysteresis			6		%

The ● denotes the specifications which apply over the full operating temperature range, otherwise specifications are at $T_A = 25^\circ\text{C}$. (Note 2) $V_{\text{INL}} = 3.3\text{V}$, $V_{\text{OLDO}} = 3\text{V}$, unless otherwise noted.

SYMBOL	PARAMETER	CONDITIONS	MIN	TYP	MAX	UNITS	
LDO Regulator							
V_{INL}	Input Voltage Range			1.8	5.5	V	
V_{OLDO}	Output Voltage Range	$I_{\text{LOAD}} = 100\text{mA}$		V_{FBL}	5	V	
I_{OUTMAX}	Max Output Current		●	100		mA	
V_{FBL}	Feedback Voltage		●	590	600	610	mV
		Line Regulation	$V_{\text{INL}} = 1.8\text{V}$ to 5.5V		0.1		%
		Load Regulation	$I_{\text{LOAD}} = 10\text{mA}$ to 90mA		0.4		%
V_{DROPOUT}	Dropout Voltage	$I_0 = 50\text{mA}$		100		mV	

ELECTRICAL CHARACTERISTICS

The ● denotes the specifications which apply over the full operating temperature range, otherwise specifications are at $T_A = 25^\circ\text{C}$. (Note 2) $V_{\text{INL}} = 3.3\text{V}$, $V_{\text{OLDO}} = 3\text{V}$, unless otherwise noted.

SYMBOL	PARAMETER	CONDITIONS	MIN	TYP	MAX	UNITS
PSRR	Ripple Rejection	$f = 2.2\text{MHz}$ at $I_{\text{LOAD}} = 100\text{mA}$ (Note 3)		24		dB
I_{SHORT}	Short Circuit Current Limit	$V_{\text{OLDO}} = 0\text{V}$	● 110	150		mA
V_{ENLDOH}	ENLDO Input High Voltage		0.8			V
V_{ENLDOL}	ENLDO Input Low Voltage				0.3	V
I_{ENLDO}	ENLDO Input Current	$V_{\text{ENLDO}} = 5.5\text{V}$		1.5		μA
V_{PGDLLOW}	PGDL Voltage Low	$I_{\text{PGDL}} = 5\text{mA}$		200		mV
I_{PGDLLEAK}	PGDL Leakage Current	$V_{\text{PGDL}} = 5.5\text{V}$		0.01	1	μA
	PGDL Trip Point	V_{FBL} Rising		96		% V_{OLDO}
	PGDL Hysteresis			3		%

Note 1: Stresses beyond those listed under Absolute Maximum Ratings may cause permanent damage to the device. Exposure to any Absolute Maximum Rating condition for extended periods may affect device reliability and lifetime.

Note 2: The LTC3537 is guaranteed to meet performance specifications from 0°C to 85°C . Specifications over the -40°C to 85°C operating temperature range are assured by design, characterization and correlation with statistical process controls.

Note 3: Specification is guaranteed by design and not 100% tested in production.

Note 4: Current measurements are made when the output is not switching.

Note 5: This IC includes overtemperature protection that is intended to protect the device during momentary overload conditions. Junction temperature will exceed 125°C when overtemperature protection is active. Continuous operation above the specified maximum operating junction temperature may result in device degradation or failure.

Note 6: Failure to solder the exposed backside of the package to the PC board ground plane will result in a thermal resistance much higher than 68°C/W .

TYPICAL PERFORMANCE CHARACTERISTICS $T_A = 25^\circ\text{C}$ unless otherwise noted.

Efficiency vs Load Current and V_{INB} for $V_{OUTB} = 1.8\text{V}$

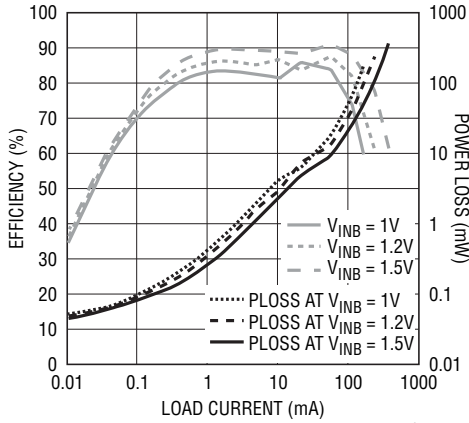

3537 G01

Efficiency vs Load Current and V_{INB} for $V_{OUTB} = 3.3\text{V}$

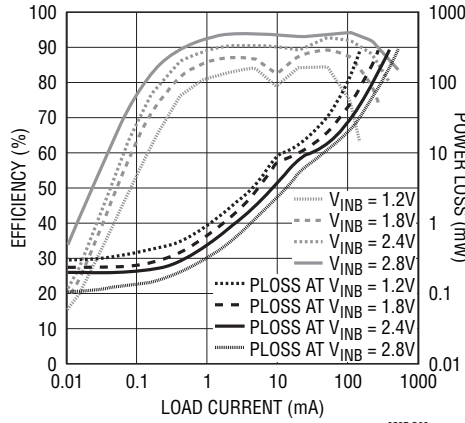

3537 G02

No-Load Input Current vs V_{INB}

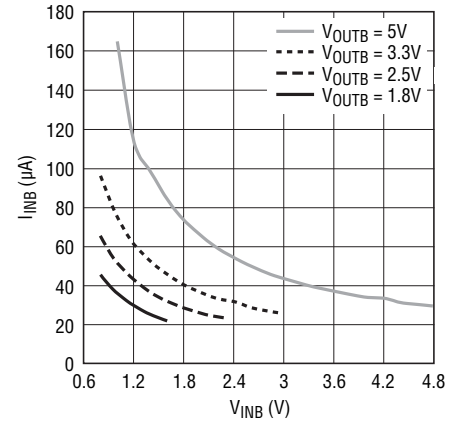

3537 G03

Efficiency vs Load Current and V_{INB} for $V_{OUTB} = 5\text{V}$

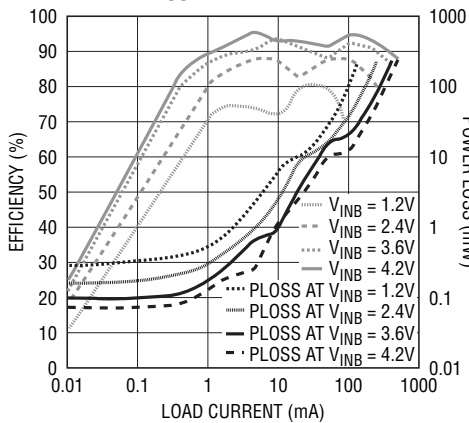

3537 G04

Maximum Output Current vs V_{INB}

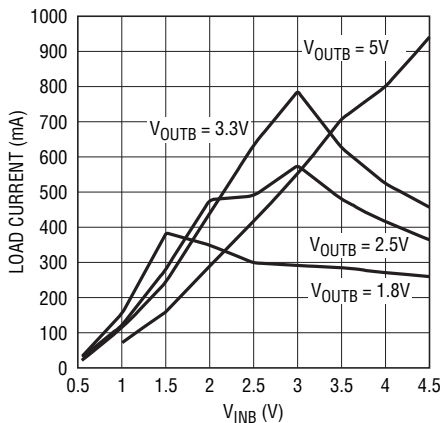

3537 G05

Minimum Load Resistance During Start-Up vs V_{INB}

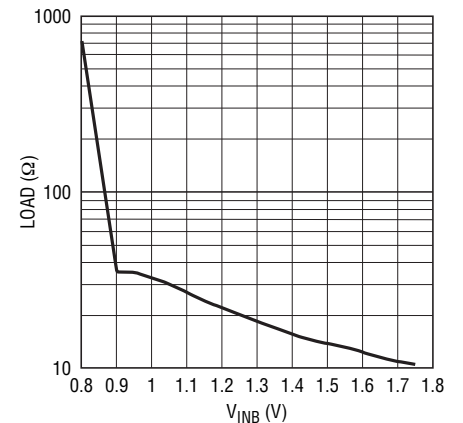

3537 G06

Start-Up Delay Time vs V_{INB}

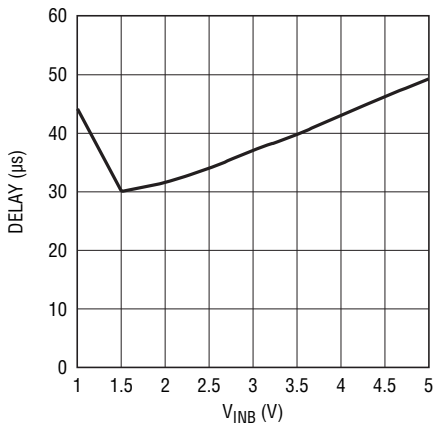

3537 G07

Burst Mode Threshold Current vs V_{INB}

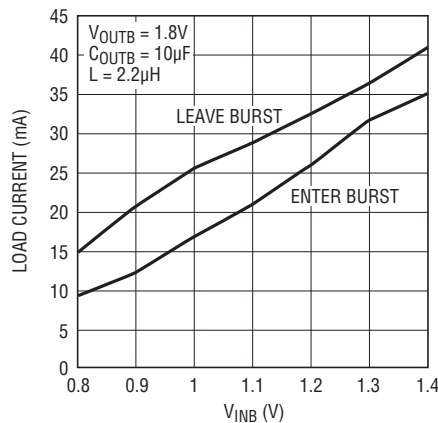

3537 G08

Burst Mode Threshold Current vs V_{INB}

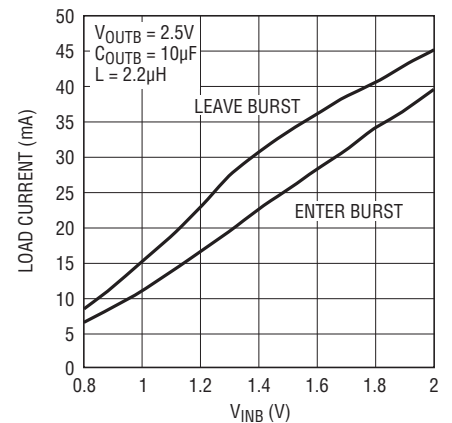

3537 G09

3537fd

TYPICAL PERFORMANCE CHARACTERISTICS $T_A = 25^\circ\text{C}$ unless otherwise noted.

Burst Mode Threshold Current vs V_{INB}

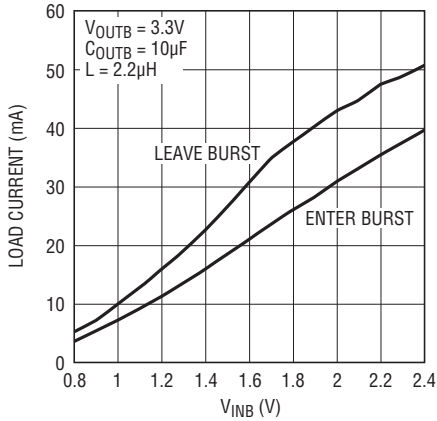

3537 G10

Burst Mode Threshold Current vs V_{INB}

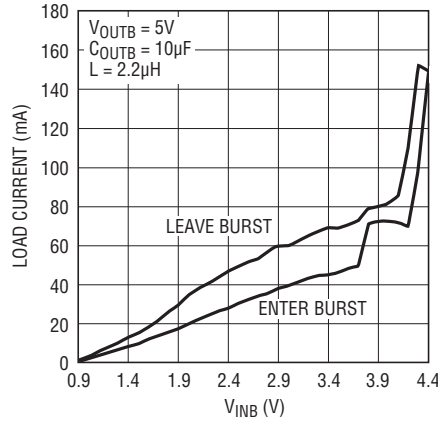

3537 G11

Oscillator Frequency Change vs V_{OUTB}

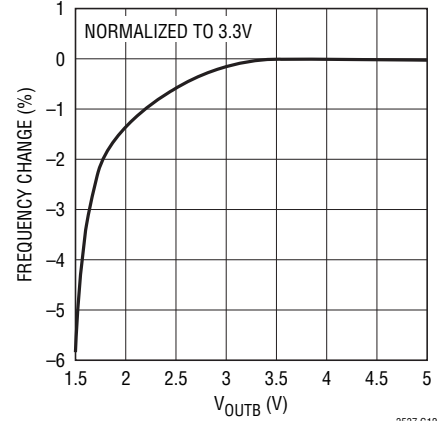

3537 G12

$R_{DS(ON)}$ vs V_{OUTB}

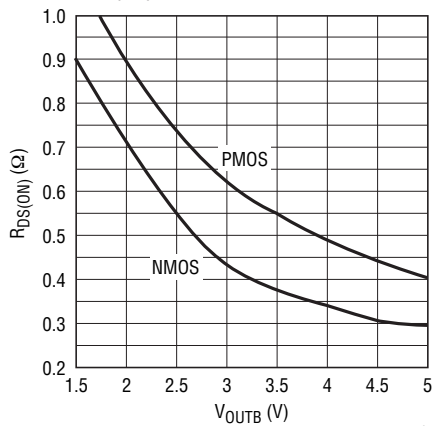

3537 G13

Oscillator Frequency Change vs Temperature

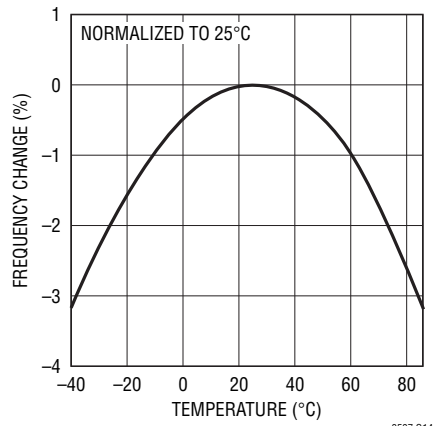

3537 G14

$R_{DS(ON)}$ Change vs Temperature

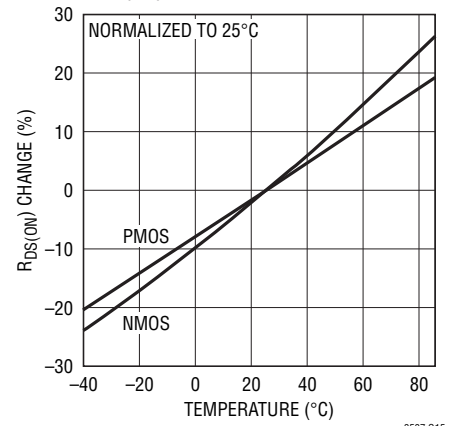

3537 G15

Feedback Voltage Change vs Temperature

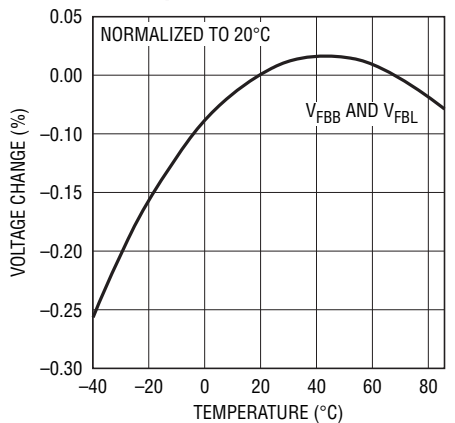

3537 G16

Start-Up Voltage vs Temperature

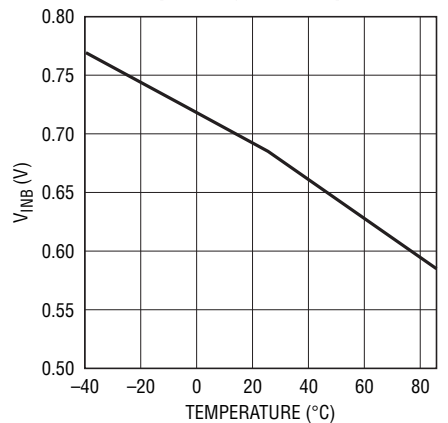

3537 G17

Burst Mode Quiescent Current vs V_{OUTB}

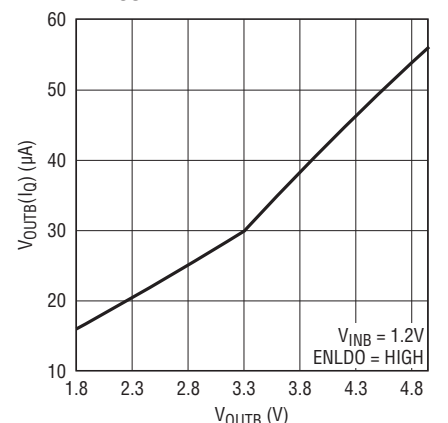

3537 G18

3537fd

TYPICAL PERFORMANCE CHARACTERISTICS $T_A = 25^\circ\text{C}$ unless otherwise noted.

Fixed Frequency Switching Waveform and V_{OUTB} Ripple

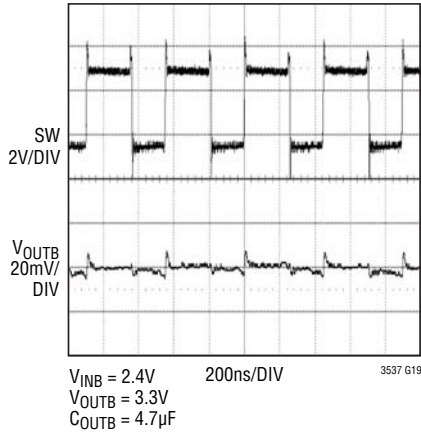

Burst Mode Waveforms

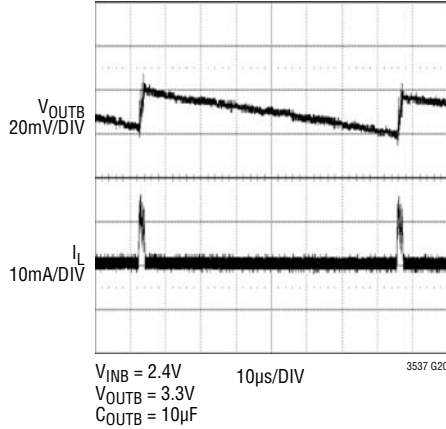

V_{OUTB} and I_{INB} During Soft-Start

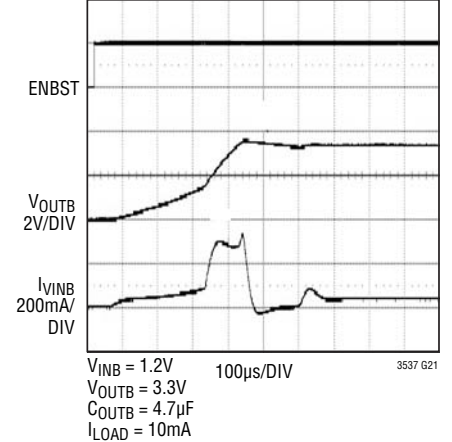

Load Current Step Response (from Burst Mode Operation)

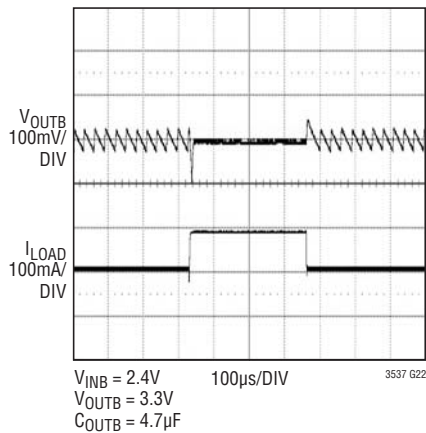

Load Current Step Response (Fixed Frequency)

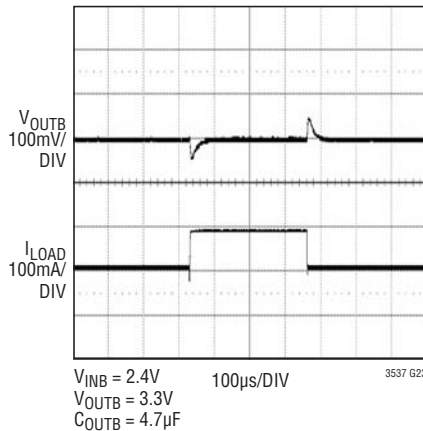

Load Current Step Response (Fixed Frequency)

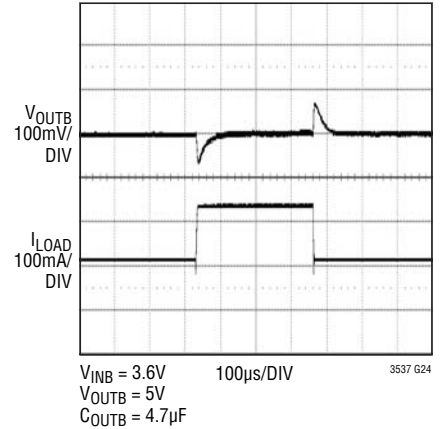

Load Current Step Response (from Burst Mode Operation)

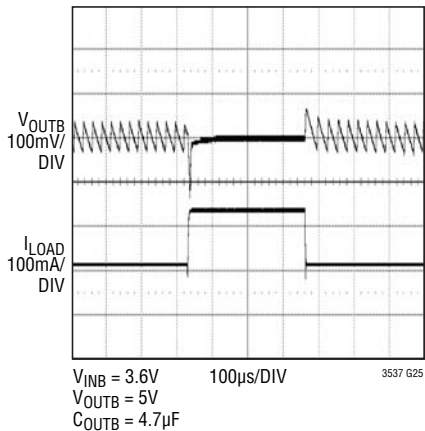

LDO Dropout Voltage vs Load Current

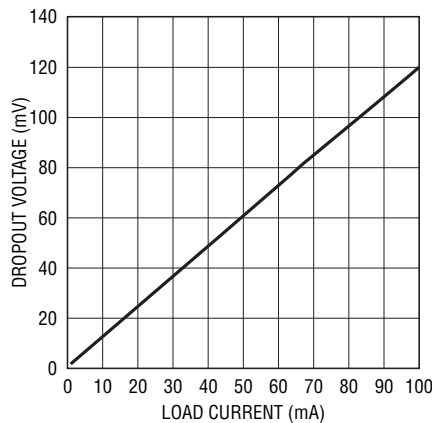

LDO Input Ripple Rejection vs Frequency

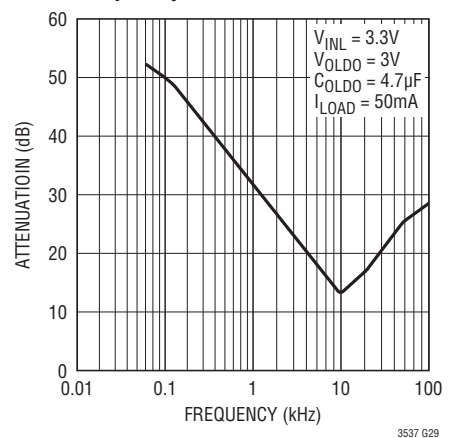

TYPICAL PERFORMANCE CHARACTERISTICS $T_A = 25^\circ\text{C}$ unless otherwise noted.

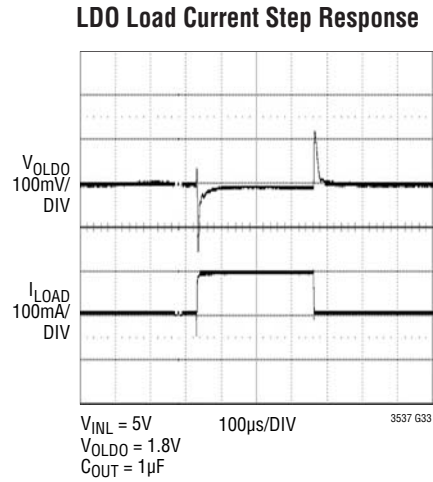
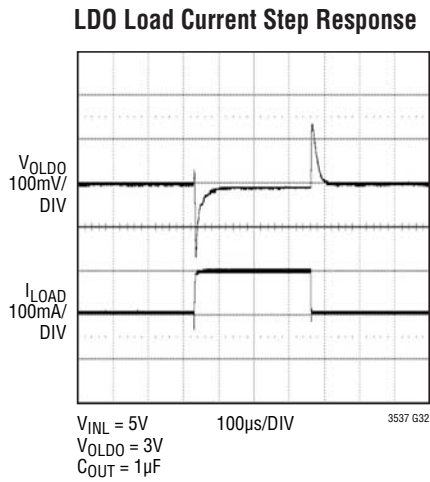
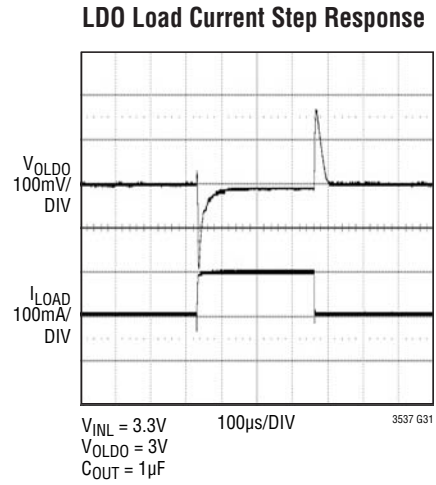
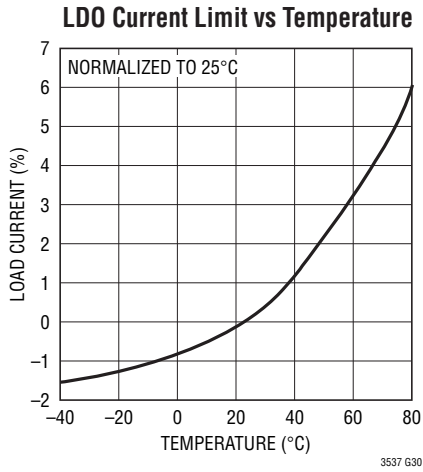

PIN FUNCTIONS

MODE (Pin 1): Logic Controlled Input for the Auto-Burst Mode Feature.

MODE = High: PWM operation with Burst Mode Operation
 MODE = Low: PWM operation only

LBI (Pin 2): Low-Battery Comparator Non-Inverting Input. (Comparator enabled with ENBST or ENLDO)

SGND (Pin 3): Signal Ground. Provide a short direct PCB path between GND and the (–) side of the input and output capacitors.

V_{INB} (Pin 4): Input Supply for the Step-Up Converter. Connect a minimum of 1μF ceramic decoupling capacitor from this pin to ground.

PGDB (Pin 5): Power Good Indicator for the Boost Converter. This is an open-drain output that sinks current when V_{OUTB} is less than 94% of the programmed voltage.

ENBST (Pin 6): Logic controlled shutdown input for the boost converter.

ENBST = High: Normal operation
 ENBST = Low: Shutdown

PGDL (Pin 7): Power Good Indicator for the LDO Regulator. This is an open-drain output that sinks current when V_{OLD0} is less than 96% of the programmed voltage.

ENLDO (Pin 8): Logic Controlled Shutdown Input for the LDO Regulator.

ENLDO = High: Normal operation
 ENLDO = Low: Shutdown

FBB (Pin 9): Feedback Input to the g_m Error Amplifier of the Boost Converter. Connect resistor divider tap to this pin. The output voltage can be adjusted from 1.5V to 5.25V by:

$$V_{OUTB} = 1.21V \cdot [1 + (R2/R1)]$$

FBL (Pin 10): Feedback Input to the g_m Error Amplifier of the LDO. Connect resistor divider tap to this pin. The output voltage can be adjusted from 0.6V (typical) to 5V by:

$$V_{OLD0} = 0.6V \cdot [1 + (R4/R3)]$$

V_{OLD0} (Pin 11): LDO Regulator Output. PCB trace from V_{OLD0} to the output filter capacitor (1μF minimum) should be as short and as wide as possible.

V_{INL} (Pin 12): Input Supply for the LDO Regulator.

V_{OUTB} (Pin 13): Output Voltage Sense Input and Drain of the Internal Synchronous Rectifier. PCB trace length from V_{OUTB} to the output filter capacitor (4.7μF minimum) should be as short and wide as possible.

SW (Pin 14): Switch Pin. Connect the inductor between SW and V_{INB}. Keep these PCB trace lengths as short and wide as possible to reduce EMI. If the inductor current falls to zero or ENBST is low, an internal anti-ringing switch is connected from SW to V_{INB} to minimize EMI.

PGND (Pin 15): Power Ground. Provide a short direct PCB path between GND and the (–) side of the input and output capacitors.

$\overline{\text{LBO}}$ (Pin 16): Low-Battery Comparator Output. (Open-Drain)

GND (Exposed Pad Pin 17): Power Ground. The Exposed Pad must be soldered to the PCB.

OPERATION

The LTC3537 is a 2.2MHz synchronous step-up (boost) converter and LDO regulator housed in a 16-lead 3mm × 3mm QFN package. Included with the ability to start up and operate from inputs less than 0.7V, the LTC3537 features fixed frequency, current mode PWM control for exceptional line and load regulation.

The current mode architecture with adaptive slope compensation provides excellent transient load response, requiring minimal output filtering. Internal soft-start and loop compensation simplifies the design process while minimizing the number of external components. With its low $R_{DS(ON)}$ and low gate charge internal N-channel MOSFET switch and P-channel MOSFET synchronous rectifier, the LTC3537 achieves high efficiency over a wide range of load currents. Automatic Burst Mode operation maintains high efficiency at very light loads, reducing the quiescent current to just 30 μ A. Operation can be best understood by referring to the Block Diagram.

LOW VOLTAGE START-UP

The LTC3537 step-up converter includes an independent start-up oscillator designed to operate at an input voltage of 0.68V (typical). Soft-start and inrush current limiting are provided during start-up, as well as normal mode.

When either V_{INB} or V_{OUTB} exceeds 1.4V typical, the IC enters normal operating mode. When the output voltage exceeds the input by 0.24V, the IC powers itself from V_{OUTB} instead of V_{INB} . At this point the internal circuitry has no dependency on the V_{INB} input voltage, eliminating the requirement for a large input capacitor. The input voltage can drop as low as 0.5V after start-up is achieved. The limiting factor for the application becomes the availability of the power source to supply sufficient energy to the output at low voltages, and maximum duty cycle, which is clamped at 92% typical. Note that at low input voltages, small voltage drops due to series resistance become critical, and greatly limit the power delivery capability of the converter.

LOW NOISE FIXED FREQUENCY OPERATION

Soft-Start

The LTC3537 contains internal circuitry to provide soft-start operation. The soft-start circuitry slowly ramps the peak inductor current from zero to its peak value of 750mA (typical) in approximately 0.5ms, allowing start-up into heavy loads. The soft-start circuitry is reset in the event of a shutdown command or a thermal shutdown.

Oscillator

An internal oscillator sets the switching frequency to 2.2MHz.

Shutdown

Shutdown of the boost converter is accomplished by pulling ENBST below 0.3V and enabled by pulling ENBST above 0.8V. Note that ENBST can be driven above V_{INB} or V_{OUTB} , as long as it is limited to less than the absolute maximum rating.

Boost Error Amplifier

The non-inverting input of the transconductance error amplifier is internally connected to the 1.2V reference and the inverting input is connected to FBB. Clamps limit the minimum and maximum error amp output voltage for improved large-signal transient response. Power converter control loop compensation is provided internally. An external resistive voltage divider from V_{OUTB} to ground programs the output voltage via FBB from 1.5V to 5.25V.

$$V_{OUTB} = 1.21V \left(1 + \frac{R2}{R1} \right)$$

Boost Current Sensing

Lossless current sensing converts the peak current signal of the N-channel MOSFET switch into a voltage that is summed with the internal slope compensation. The summed signal is compared to the error amplifier output to provide a peak current control command for the PWM.

OPERATION

Boost Current Limit

The current limit comparator shuts off the N-channel MOSFET switch once its threshold is reached. The current limit comparator delay to output is typically 40ns. Peak switch current is limited to approximately 750mA, independent of input or output voltage, unless V_{OUTB} falls below 0.8V, in which case the current limit is cut in half.

Boost Zero Current Comparator

The zero current comparator monitors the inductor current to the output and shuts off the synchronous rectifier when this current reduces to approximately 30mA. This prevents the inductor current from reversing in polarity, improving efficiency at light loads.

Boost Synchronous Rectifier

To control inrush current and to prevent the inductor current from running away when V_{OUTB} is close to V_{INB} , the P-channel MOSFET synchronous rectifier is only enabled when $V_{OUTB} > (V_{INB} + 0.24V)$.

Boost Anti-Ringing Control

The anti-ringing control connects a resistor across the inductor to prevent high frequency ringing on the SW pin during discontinuous current mode operation. Although the ringing of the resonant circuit formed by L and C_{SW} (capacitance on SW pin) is low energy, it can cause EMI radiation.

Boost Output Disconnect

The LTC3537 is designed to allow true output disconnect by eliminating body diode conduction of the internal P-channel MOSFET synchronous rectifier. This allows V_{OUTB} to go to zero volts during shutdown, drawing no current from the input source. It also allows inrush current limiting at turn-on, minimizing surge currents seen by the input supply. Note that to obtain the advantages of output disconnect, there cannot be an external Schottky diode connected between the SW pin and V_{OUTB} . The output disconnect feature also allows V_{OUTB} to be pulled high, above the nominal regulation voltage, without any reverse current into the power source connected to V_{INB} .

Thermal Overload Protection

If the die temperature exceeds 160°C typical, the LTC3537 boost converter will shut down. All switches will be off and the soft-start capacitor will be discharged. The boost converter will be enabled when the die temperature drops by approximately 15°C.

BOOST BURST MODE OPERATION

When enabled (MODE pin high), the LTC3537 will automatically enter Burst Mode operation at light load current and return to fixed frequency PWM mode when the load increases. Refer to the Typical Performance Characteristics to see the Burst Mode Threshold Current vs V_{INB} . The load current at which Burst Mode operation is entered can be changed by adjusting the inductor value. Raising the inductor value will lower the load current at which Burst Mode operation is entered.

In Burst Mode operation, the LTC3537 still switches at a fixed frequency of 2.2MHz, using the same error amplifier and loop compensation for peak current mode control. This control method eliminates any output transient when switching between modes. In Burst Mode operation, energy is delivered to the output until it reaches the nominal voltage regulation value, then the LTC3537 transitions to sleep mode where the outputs are off and the LTC3537 consumes only 30 μ A of quiescent current from V_{OUTB} including the current required to keep the LDO enabled. When the output voltage droops slightly, switching resumes. This maximizes efficiency at very light loads by minimizing switching and quiescent losses. Burst Mode output voltage ripple, which is typically 1% peak-to-peak, can be reduced by using more output capacitance (10 μ F or greater), or with a small capacitor (10pF to 50pF) connected between V_{OUTB} and FBB.

As the load current increases, the LTC3537 will automatically leave Burst Mode operation. Note that larger output capacitor values may cause this transition to occur at lighter loads. Once the LTC3537 has left Burst Mode operation and returned to normal operation, it will remain there until the output load is reduced below the burst threshold.

OPERATION

Burst Mode operation is inhibited during start-up and soft-start and until V_{OUTB} is at least 0.24V greater than V_{INB} .

The LTC3537 will operate at a continuous PWM frequency of 2.2MHz by connecting MODE to GND. At very light loads, the LTC3537 will exhibit pulse-skip operation.

Single Cell to 5V Step-Up Applications

Due to the high inductor current slew rate in applications boosting to 5V from a single-cell (alkaline, NiCd or NiMH), the LTC3537 may not enter Burst Mode operation for input voltages less than 1.2V. Refer to the Typical Performance Characteristics curves for the Burst Mode thresholds for different input and output voltages.

LDO REGULATOR OPERATION

The LTC3537 includes an independent 100mA low dropout linear regulator (LDO). The V_{INL} pin can be connected to an independent source or connected to the output of the boost regulator. An input capacitor on V_{INL} is optional, but it will help to improve transient responses. The LDO will operate with a V_{INL} down to 1.5V, but specifications are guaranteed with V_{INL} from 1.8V to 5.5V.

Shutdown

Shutdown of the LDO is accomplished by pulling ENLDO below 0.3V and enabled by pulling ENLDO above 0.8V. Note that ENLDO can be driven above V_{INL} or V_{OLDO} , as long as it is limited to less than the absolute maximum rating. In the event that the LDO output voltage is held above the input voltage, the LDO goes in to shutdown until the output drops back below the input voltage. In shutdown the LDO will block reverse current from V_{OLDO} to V_{INL} .

LDO Error Amplifier

The non-inverting input of the transconductance error amplifier is internally connected to a 0.6V reference and the inverting input is connected to FBL. The control loop compensation is provided internally. An external resistive voltage divider from V_{OLDO} to ground programs the output voltage via FBL from 0.6V to 5V.

$$V_{OLDO} = 0.6V \left(1 + \frac{R4}{R3} \right)$$

LDO Current Sensing and Limiting

Current is sensed across an internal resistor. The guaranteed minimum output current is 100mA.

LOW-BATTERY INDICATOR

The LTC3537 includes a low-battery comparator. The non-inverting input of the comparator is internally connected to a 0.58V reference and the inverting input is connected to LBI. An external resistive voltage divider from V_{INL} to ground programs the threshold voltage. When the voltage at LBI drops below 0.58V, the open-drain N-channel MOSFET will turn on. The N-channel MOSFET device is forced off when both the step-up converter and LDO are in shutdown.

$$V_{LBI} = 0.58V \left(1 + \frac{R6}{R5} \right)$$

BOOST POWER-GOOD INDICATOR

The LTC3537 includes a power-good comparator for the step-up converter. The non-inverting input of the comparator is internally connected to a 1.08V reference and the inverting input is connected to the FBB pin. The open-drain MOSFET on PGDB will turn off when the output voltage is typically within 6% of the programmed output voltage.

Output sequencing can be achieved by connecting PGDB to the LDO enable pin (ENLDO). This would allow the user to keep the LDO off until the step-up converter is regulating. The N-channel MOSFET is forced on in shutdown.

LDO POWER-GOOD INDICATOR

The LTC3537 includes a power-good comparator for the LDO. The non-inverting input of the comparator is internally connected to a 540mV reference and the inverting input is connected to the FBL pin. The open-drain MOSFET on the PGDL pin will turn off when the output voltage is typically within 4% of the programmed output voltage.

Output sequencing can be achieved by connecting PGDL to the boost enable pin (ENBST). This would allow the user to keep the step-up converter off until the LDO is regulating. The N-channel MOSFET is forced on in shutdown.

APPLICATIONS INFORMATION

$V_{INB} > V_{OUTB}$ OPERATION

The LTC3537 step-up converter will maintain voltage regulation even when the input voltage is above the desired output voltage. Note that the efficiency is much lower in this mode, and the maximum output current capability will be less. Refer to the Typical Performance Characteristics.

STEP-UP SHORT-CIRCUIT PROTECTION

The LTC3537 output disconnect feature provides output short circuit protection. To reduce power dissipation under short-circuit conditions, the peak switch current limit is reduced to 400mA (typical).

SCHOTTKY DIODE

Although it is not required, adding a Schottky diode from SW to V_{OUTB} will improve efficiency by about 4%. Note that this defeats the output disconnect and short-circuit protection features.

PCB LAYOUT GUIDELINES

The high speed operation of the LTC3537 demands careful attention to board layout. A careless layout will result in reduced performance. Figure 1 shows the recommended component placement. A large ground pin copper area

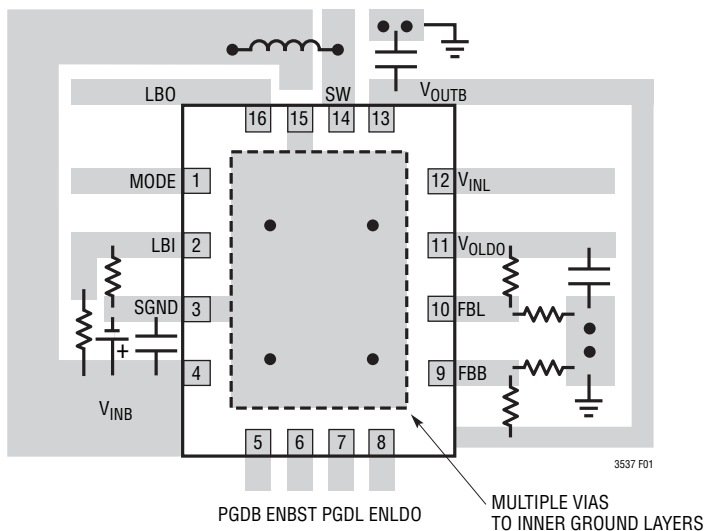

Figure 1

will help to lower the die temperature. A multilayer board with a separate ground plane is ideal, but not absolutely necessary.

COMPONENT SELECTION

Inductor Selection

The LTC3537 can utilize small surface mount chip inductors due to its fast 2.2MHz switching frequency. Inductor values between $1\mu\text{H}$ and $4.7\mu\text{H}$ are suitable for most applications. Larger values of inductance will allow slightly greater output current capability (and lower the Burst Mode threshold) by reducing the inductor ripple current. Increasing the inductance above $10\mu\text{H}$ will increase size while providing little improvement in output current capability. The minimum inductance value is given by:

$$L > \frac{V_{INB(MIN)} \cdot (V_{OUTB(MAX)} - V_{INB(MIN)})}{2.2 \cdot \text{Ripple} \cdot V_{OUTB(MAX)}}$$

where:

Ripple = Allowable inductor current ripple (amps peak-peak)

$V_{INB(MIN)}$ = Minimum converter input voltage

$V_{OUTB(MAX)}$ = Maximum output voltage

The inductor current ripple is typically set for 20% to 40% of the maximum inductor current. High frequency ferrite core inductor materials reduce frequency dependent power losses compared to cheaper powdered iron types, improving efficiency. The inductor should have low ESR (series resistance of the windings) to reduce the I^2R power losses, and must be able to support the peak inductor current without saturating. Molded chokes and some chip inductors usually do not have enough core area to support the peak inductor currents of 750mA seen on the LTC3537. To minimize radiated noise, use a shielded inductor. See Table 1 for suggested components and suppliers.

APPLICATIONS INFORMATION

Table 1: Recommended Inductors

VENDOR	PART/STYLE
Coilcraft (847) 639-6400 www.coilcraft.com	LPO4815 LPS4012, LPS4018 MSS5131 MSS4020 MOS6020 ME3220 DS1605, DO1608
Coiltronics www.cooperet.com	SD10, SD12, SD14, SD18, SD20, SD52, SD3114, SD3118
FDK (408) 432-8331 www.fdk.com	MIP3226D4R7M, MIP3226D3R3M MIPF2520D4R7 MIPWT3226D3R0
Murata (714) 852-2001 www.murata.com	LQH43C LQH32C (-53 series) 301015
Sumida (847) 956-0666 www.sumida.com	CDRH5D18 CDRH2D14 CDRH3D16 CDRH3D11 CR43 CMD4D06-4R7MC CMD4D06-3R3MC
Taiyo-Yuden www.t-yuden.com	NP03SB NR3015T NR3012T
TDK (847) 803-6100 www.component.tdk.com	VLP VLF, VLFC
Toko (408) 432-8282 www.tokoam.com	D412C D518LC D52LC D62LCB
Würth (201) 785-8800 www.we-online.com	WE-TPC Type S, M

Output and Input Capacitor Selection

Low ESR (equivalent series resistance) capacitors should be used to minimize the output voltage ripple. Multilayer ceramic capacitors are an excellent choice as they have extremely low ESR and are available in small footprints. A 4.7 μ F to 10 μ F output capacitor is sufficient for most boost applications. Larger values up to 22 μ F may be used to obtain extremely low output voltage ripple and improve transient response. X5R and X7R dielectric materials are preferred for their ability to maintain capacitance over

wide voltage and temperature ranges. Y5V types should not be used.

The internal loop compensation of the LTC3537 is designed to be stable with a minimum output capacitor value of 4.7 μ F when in PWM mode on the boost regulator and 1 μ F or greater on the LDO regulator. Although ceramic capacitors are recommended, low ESR tantalum capacitors may be used as well. For the LDO, see Figures 2 and 3 for output capacitor value and ESR requirements. To reduce Burst Mode boost output voltage ripple, 10 μ F is recommended.

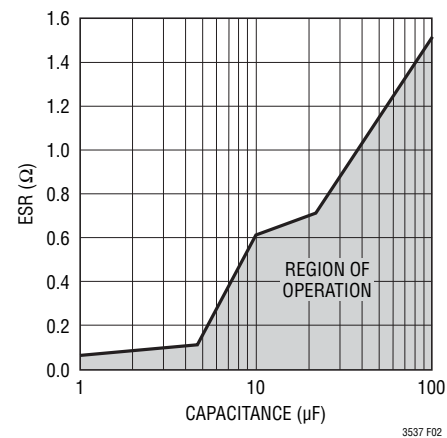
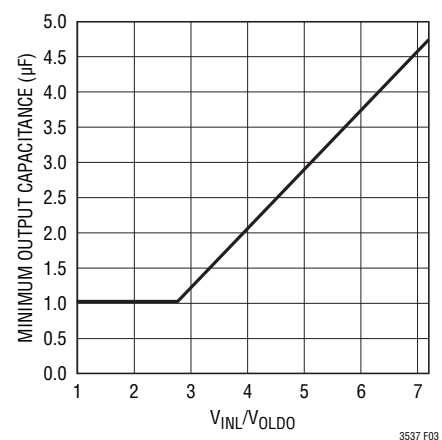
Figure 2. LDO Regulator Output Capacitance vs ESR

Figure 3. LDO Regulator Minimum Output Capacitance vs V_{INL}/V_{OLDO}

APPLICATIONS INFORMATION

For the step-up converter, a tantalum capacitor may be used in demanding applications that have large load transients. Another method of improving the transient response is to add a small feedforward capacitor across the top resistor of the feedback divider (from V_{OUTB} to FBB). A typical value of 22pF will generally suffice.

Ceramic capacitors are also a good choice for input decoupling of the step-up converter and should be located as close as possible to the device. A 2.2 μ F input capacitor is sufficient for most applications, although larger values may be used without limitations. The LDO regulator will have improved performance with an input capacitor, but

it is not required. Table 2 shows a list of several ceramic capacitor manufacturers. Consult the manufacturers directly for detailed information on their selection of ceramic capacitors.

Table 2. Capacitor Vendor Information

SUPPLIER	PHONE	WEBSITE
AVX	(803) 448-9411	www.avxcorp.com
Murata	(714) 852-2001	www.murata.com
Taiyo-Yuden	(408) 573-4150	www.t-yuden.com
TDK	(847) 803-6100	www.component.tdk.com
Samsung	(408) 544-5200	www.sem.samsung.com

TYPICAL APPLICATIONS

Li-Ion to 5V, 3.3V

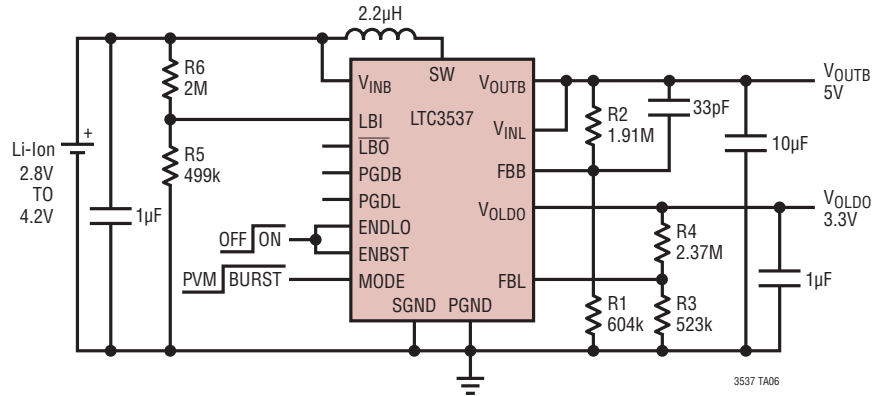

Single Cell or 5V Input to 3.3V

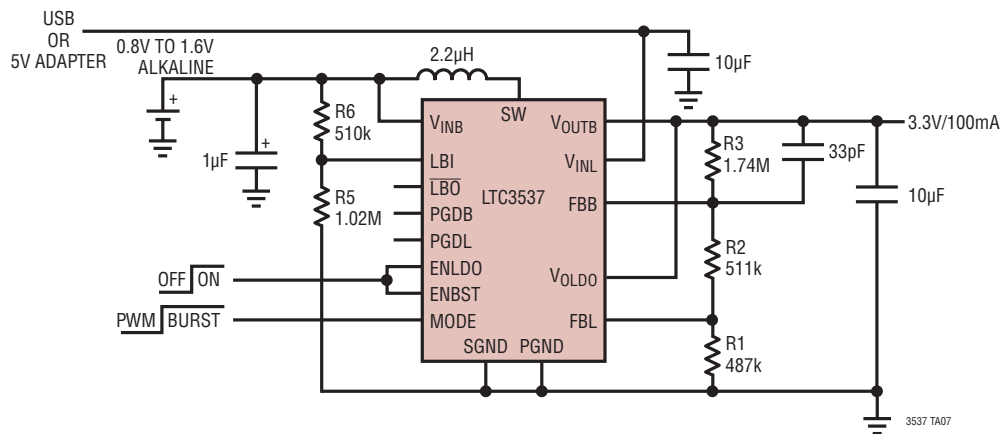

PACKAGE DESCRIPTION

UD Package
16-Lead Plastic QFN (3mm × 3mm)
 (Reference LTC DWG # 05-08-1691)

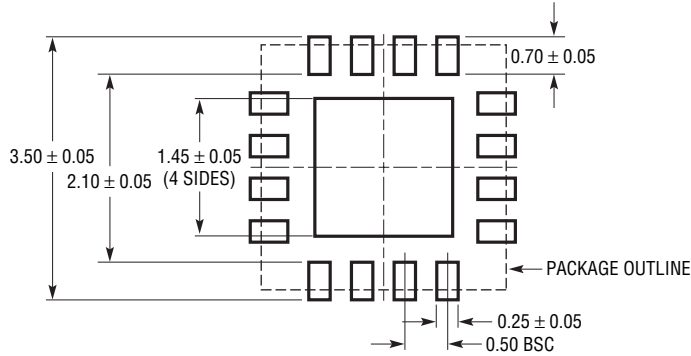

RECOMMENDED SOLDER PAD PITCH AND DIMENSIONS

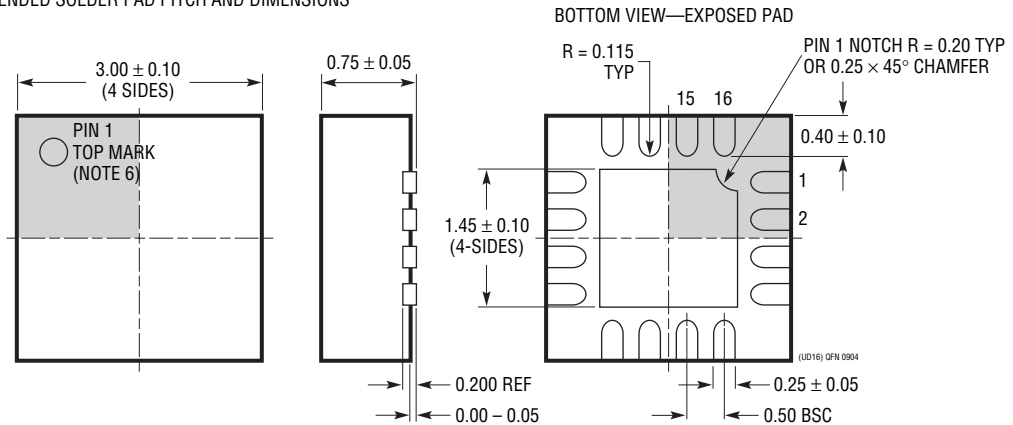

- NOTE:
1. DRAWING CONFORMS TO JEDEC PACKAGE OUTLINE MO-220 VARIATION (WEED-2)
 2. DRAWING NOT TO SCALE
 3. ALL DIMENSIONS ARE IN MILLIMETERS
 4. DIMENSIONS OF EXPOSED PAD ON BOTTOM OF PACKAGE DO NOT INCLUDE MOLD FLASH. MOLD FLASH, IF PRESENT, SHALL NOT EXCEED 0.15mm ON ANY SIDE
 5. EXPOSED PAD SHALL BE SOLDER PLATED
 6. SHADED AREA IS ONLY A REFERENCE FOR PIN 1 LOCATION ON THE TOP AND BOTTOM OF PACKAGE

REVISION HISTORY (Revision history begins at Rev D)

REV	DATE	DESCRIPTION	PAGE NUMBER
D	12/12	Corrected from LBO to \overline{LBO} Corrected Burst Mode Quescent Current Graph Corrected Typos	Throughout 6 9

RELATED PARTS

PART NUMBER	DESCRIPTION	COMMENTS
LTC3401	1A (I_{SW}), 3MHz, Synchronous Step-Up DC/DC Converter	97% Efficiency, V_{IN} : 0.5V to 5V, $V_{OUT(MAX)}$ = 6V, I_Q = 38 μ A, I_{SD} < 1 μ A, 10-Lead MS Package
LTC3402	2A (I_{SW}), 3MHz, Synchronous Step-Up DC/DC Converter	97% Efficiency, V_{IN} : 0.5V to 5V, $V_{OUT(MAX)}$ = 6V, I_Q = 38 μ A, I_{SD} < 1 μ A, 10-Lead MS Package
LTC3421	3A (I_{SW}), 3MHz, Synchronous Step-Up DC/DC Converter with Output Disconnect	95% Efficiency, V_{IN} : 0.5V to 4.5V, $V_{OUT(MAX)}$ = 5.25V, I_Q = 12 μ A, I_{SD} < 1 μ A, QFN24 Package
LTC3422	1.5A (I_{SW}), 3MHz Synchronous Step-Up DC/DC Converter with Output Disconnect	95% Efficiency, V_{IN} : 0.5V to 4.5V, $V_{OUT(MAX)}$ = 5.25V, I_Q = 25 μ A, I_{SD} < 1 μ A, 3mm \times 3mm DFN Package
LTC3423/LTC3424	1A/2A (I_{SW}), 3MHz, Synchronous Step-Up DC/DC Converters	95% Efficiency, V_{IN} : 0.5V to 5.5V, $V_{OUT(MAX)}$ = 5.5V, I_Q = 38 μ A, I_{SD} < 1 μ A, 10-Lead MS Package
LTC3426	2A (I_{SW}), 1.2MHz, Step-Up DC/DC Converter	92% Efficiency, V_{IN} : 1.6V to 4.3V, $V_{OUT(MAX)}$ = 5V, I_{SD} < 1 μ A, SOT-23 Package
LTC3428	500mA (I_{SW}), 1.25MHz/2.5MHz, Synchronous Step-Up DC/DC Converters with Output Disconnect	92% Efficiency, V_{IN} : 1.8V to 5V, $V_{OUT(MAX)}$ = 5.25V, I_{SD} < 1 μ A, 2mm \times 2mm DFN Package
LTC3429	600mA (I_{SW}), 500kHz, Synchronous Step-Up DC/DC Converter with Output Disconnect and Soft-Start	96% Efficiency, V_{IN} : 0.5V to 4.4V, $V_{OUT(MAX)}$ = 5V, I_Q = 20 μ A/300 μ A, I_{SD} < 1 μ A, ThinSOT Package
LTC3458	1.4A (I_{SW}), 1.5MHz, Synchronous Step-Up DC/DC Converter/Output Disconnect/Burst Mode Operation	93% Efficiency, V_{IN} : 1.5V to 6V, $V_{OUT(MAX)}$ = 7.5V, I_Q = 15 μ A, I_{SD} < 1 μ A, DFN12 Package
LTC3458L	1.7A (I_{SW}), 1.5MHz, Synchronous Step-Up DC/DC Converter with Output Disconnect, Automatic Burst Mode Operation	94% Efficiency, $V_{OUT(MAX)}$ = 6V, I_Q = 12 μ A, DFN12 Package
LTC3459	70mA (I_{SW}), 10V Micropower Synchronous Boost Converter/Output Disconnect/Burst Mode Operation	V_{IN} : 1.5V to 5.5V, $V_{OUT(MAX)}$ = 10V, I_Q = 10 μ A, I_{SD} < 1 μ A, ThinSOT Package
LTC3522	400mA Synchronous Buck-Boost and 200mA Synchronous Buck Converter	95% Efficiency, V_{IN} : 2.4V to 5.5V, V_{OUT} : 5.25V to 0.6V, I_Q = 25 μ A, I_{SD} < 1 μ A, 3mm \times 3mm DFN Package
LTC3525-3/ LTC3525-3.3/ LTC3525-5	400mA Micropower Synchronous Step-Up DC/DC Converter with Output Disconnect	95% Efficiency, V_{IN} : 1V to 4.5V, V_{OUT} = 3.0V, 3.3V or 5V, I_Q = 7 μ A, I_{SD} < 1 μ A, SC-70 Package
LTC3525L-3	400mA Micropower Synchronous Step-Up DC/DC Converter with Output Disconnect	90% Efficiency, V_{IN} : 0.7V to 4.5V, V_{OUT} = 3V, I_Q = 7 μ A, I_{SD} < 1 μ A, SC70 Package
LTC3526L/ LTC3526LB	550mA, 1MHz Synchronous Step-Up DC/DC Converter	95% Efficiency, V_{IN} : 0.75V to 5V, $V_{OUT(MAX)}$: 1.5V to 5.25V, I_Q = 9 μ A, I_{SD} < 1 μ A, DFN6 Package
LTC3528/ LTC3528B	1A, 1MHz, Synchronous Step-Up DC/DC Converters	94% Efficiency, V_{IN} : 0.7V to 5V, V_{OUT} : 1.6V to 5.25V, I_Q = 12 μ A, I_{SD} < 1 μ A, 2mm \times 3mm DFN Package, LTC3528B (PWM Mode Only)

ThinSOT is a trademark of Linear Technology Corporation.