

- 8 A RMS
- Glass Passivated Wafer
- 400 V to 800 V Off-State Voltage
- Max  $I_{GT}$  of 50 mA (Quadrants 1 - 3)

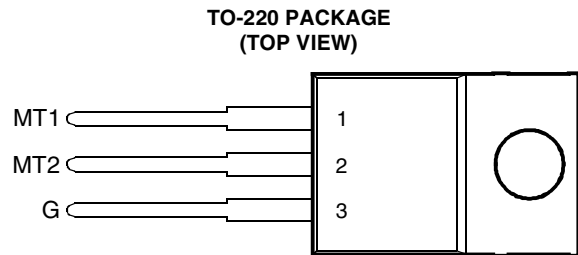

Pin 2 is in electrical contact with the mounting base.

MDC2ACA

**absolute maximum ratings over operating case temperature (unless otherwise noted)**

RATING		SYMBOL	VALUE	UNIT
Repetitive peak off-state voltage (see Note 1)	TIC226D	$V_{DRM}$	400	V
	TIC226M		600	
	TIC226S		700	
	TIC226N		800	
Full-cycle RMS on-state current at (or below) 85°C case temperature (see Note 2)		$I_{T(RMS)}$	8	A
Peak on-state surge current full-sine-wave at (or below) 25°C case temperature (see Note 3)		$I_{TSM}$	70	A
Peak gate current		$I_{GM}$	±1	A
Peak gate power dissipation at (or below) 85°C case temperature (pulse width ≤ 200 μs)		$P_{GM}$	2.2	W
Average gate power dissipation at (or below) 85°C case temperature (see Note 4)		$P_{G(AV)}$	0.9	W
Operating case temperature range		$T_C$	-40 to +110	°C
Storage temperature range		$T_{stg}$	-40 to +125	°C
Lead temperature 1.6 mm from case for 10 seconds		$T_L$	230	°C

- NOTES: 1. These values apply bidirectionally for any value of resistance between the gate and Main Terminal 1.  
 2. This value applies for 50-Hz full-sine-wave operation with resistive load. Above 85°C derate linearly to 110°C case temperature at the rate of 320 mA/°C.  
 3. This value applies for one 50-Hz full-sine-wave when the device is operating at (or below) the rated value of on-state current. Surge may be repeated after the device has returned to original thermal equilibrium. During the surge, gate control may be lost.  
 4. This value applies for a maximum averaging time of 20 ms.

**electrical characteristics at 25°C case temperature (unless otherwise noted)**

PARAMETER	TEST CONDITIONS			MIN	TYP	MAX	UNIT
$I_{DRM}$ Repetitive peak off-state current	$V_D = \text{rated } V_{DRM}$	$I_G = 0$	$T_C = 110^\circ\text{C}$			±2	mA
$I_{GT}$ Gate trigger current	$V_{supply} = +12 \text{ V}^\dagger$	$R_L = 10 \Omega$	$t_{p(g)} > 20 \mu\text{s}$		6	50	mA
	$V_{supply} = +12 \text{ V}^\dagger$	$R_L = 10 \Omega$	$t_{p(g)} > 20 \mu\text{s}$		-12	-50	
	$V_{supply} = -12 \text{ V}^\dagger$	$R_L = 10 \Omega$	$t_{p(g)} > 20 \mu\text{s}$		-10	-50	
	$V_{supply} = -12 \text{ V}^\dagger$	$R_L = 10 \Omega$	$t_{p(g)} > 20 \mu\text{s}$		25		
$V_{GT}$ Gate trigger voltage	$V_{supply} = +12 \text{ V}^\dagger$	$R_L = 10 \Omega$	$t_{p(g)} > 20 \mu\text{s}$		0.7	2	V
	$V_{supply} = +12 \text{ V}^\dagger$	$R_L = 10 \Omega$	$t_{p(g)} > 20 \mu\text{s}$		-0.8	-2	
	$V_{supply} = -12 \text{ V}^\dagger$	$R_L = 10 \Omega$	$t_{p(g)} > 20 \mu\text{s}$		-0.8	-2	
	$V_{supply} = -12 \text{ V}^\dagger$	$R_L = 10 \Omega$	$t_{p(g)} > 20 \mu\text{s}$		0.9	2	
$V_T$ On-state voltage	$I_T = \pm 12 \text{ A}$	$I_G = 50 \text{ mA}$	(see Note 5)		±1.5	±2.1	V

† All voltages are with respect to Main Terminal 1.

**PRODUCT INFORMATION**

APRIL 1971 - REVISED SEPTEMBER 2002  
 Specifications are subject to change without notice.

electrical characteristics at 25°C case temperature (unless otherwise noted) (continued)

PARAMETER	TEST CONDITIONS			MIN	TYP	MAX	UNIT
I <sub>H</sub> Holding current	V <sub>supply</sub> = +12 V†	I <sub>G</sub> = 0	Init' I <sub>TM</sub> = 100 mA		10	30	mA
	V <sub>supply</sub> = -12 V†	I <sub>G</sub> = 0	Init' I <sub>TM</sub> = -100 mA		-6	-30	
I <sub>L</sub> Latching current	V <sub>supply</sub> = +12 V†	(see Note 6)				50	mA
	V <sub>supply</sub> = -12 V†					-50	
dv/dt Critical rate of rise of off-state voltage	V <sub>DRM</sub> = Rated V <sub>DRM</sub>	I <sub>G</sub> = 0	T <sub>C</sub> = 110°C		±100		V/μs
dv/dt <sub>(c)</sub> Critical rise of commutation voltage	V <sub>DRM</sub> = Rated V <sub>DRM</sub>	I <sub>TRM</sub> = ±12 A	T <sub>C</sub> = 85°C (see figure 7)	±5			V/μs

† All voltages are with respect to Main Terminal 1.

NOTES: 5. This parameter must be measured using pulse techniques, t<sub>p</sub> ≤ 1 ms, duty cycle ≤ 2 %. Voltage-sensing contacts separate from the current carrying contacts are located within 3.2 mm from the device body.

6. The triacs are triggered by a 15-V (open-circuit amplitude) pulse supplied by a generator with the following characteristics:  
R<sub>G</sub> = 100 Ω, t<sub>p(g)</sub> = 20 μs, t<sub>r</sub> ≤ 15 ns, f = 1 kHz.

thermal characteristics

PARAMETER	MIN	TYP	MAX	UNIT
R <sub>θJC</sub> Junction to case thermal resistance			1.8	°C/W
R <sub>θJA</sub> Junction to free air thermal resistance			62.5	°C/W

TYPICAL CHARACTERISTICS

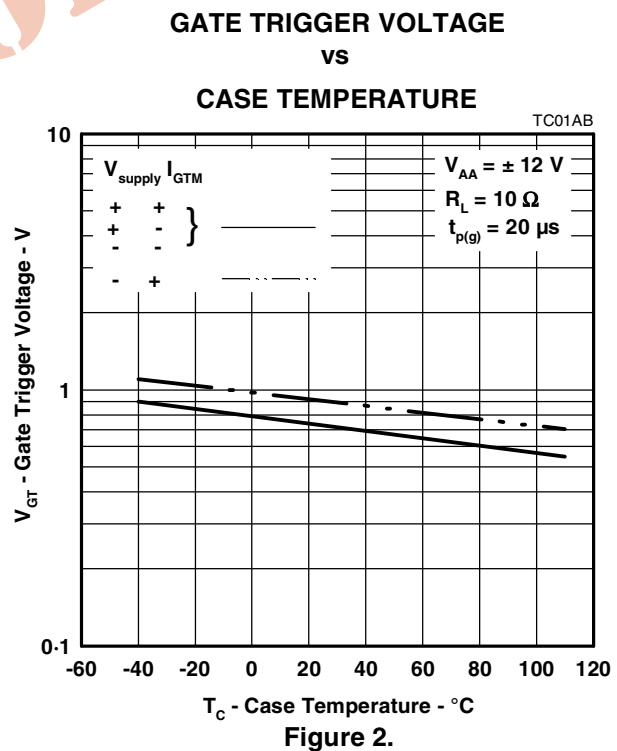
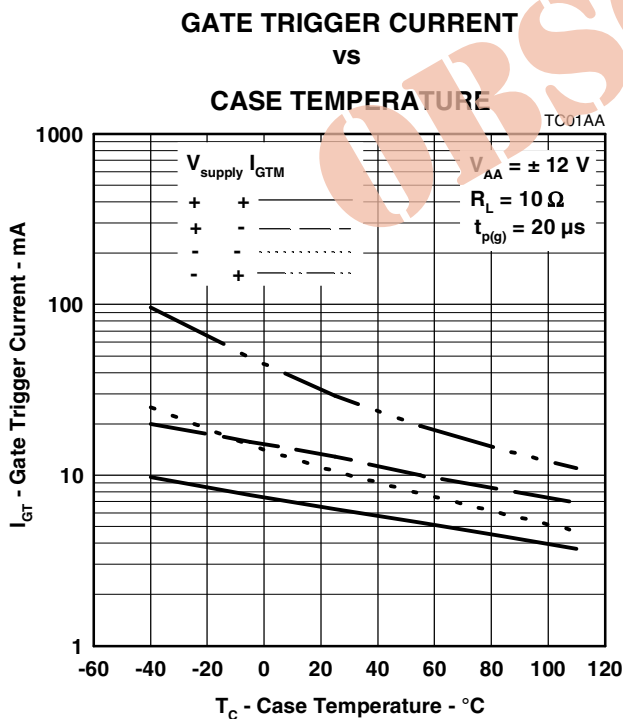

**PRODUCT INFORMATION**

APRIL 1971 - REVISED SEPTEMBER 2002  
Specifications are subject to change without notice.

TYPICAL CHARACTERISTICS

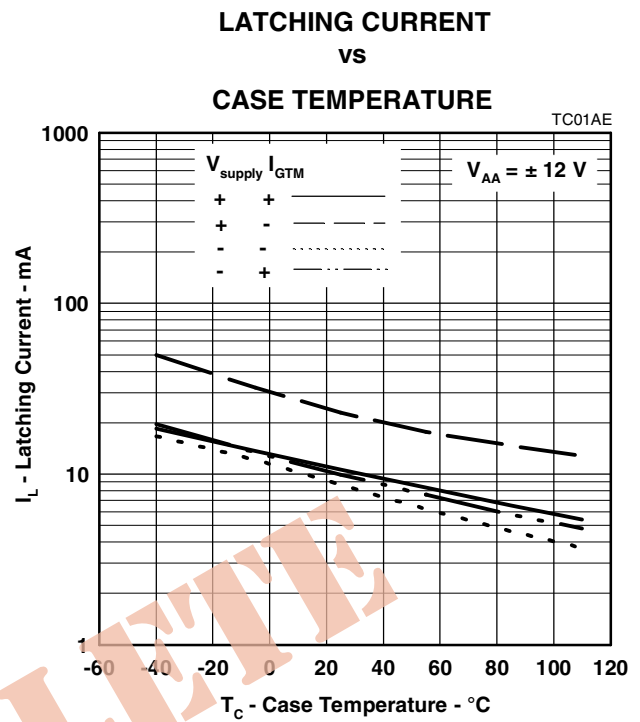
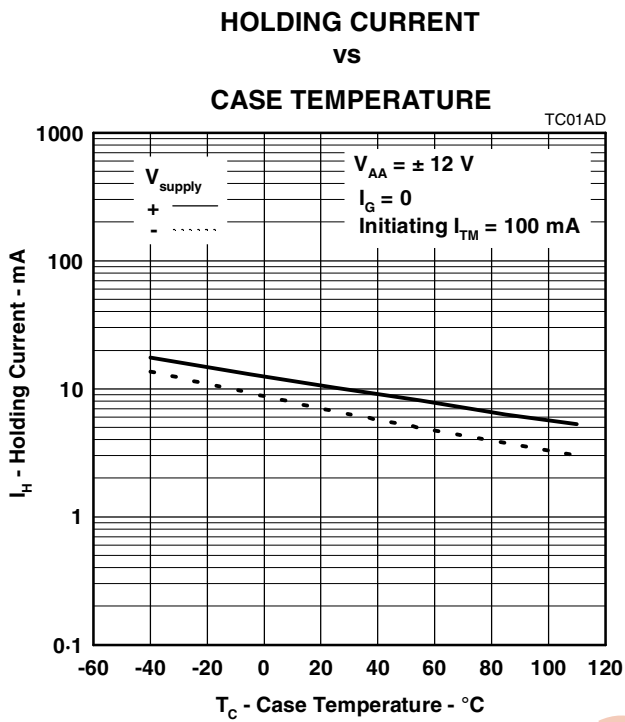

THERMAL INFORMATION

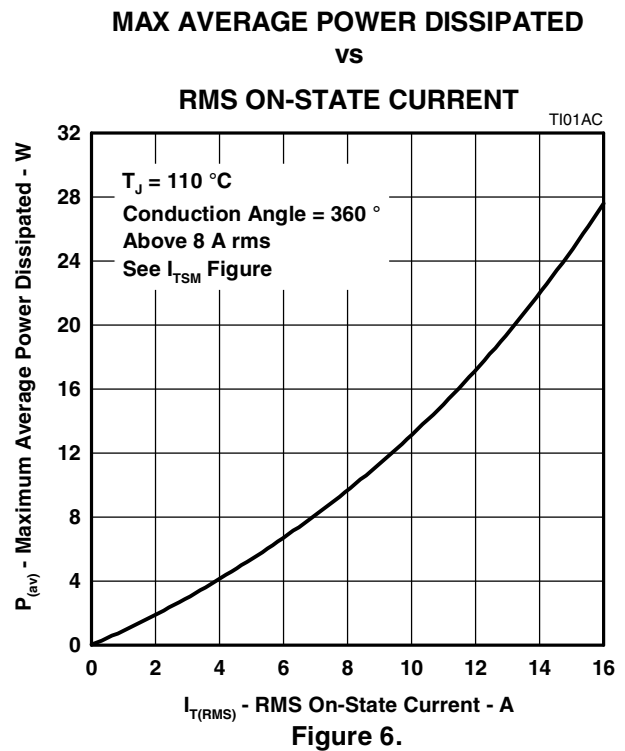
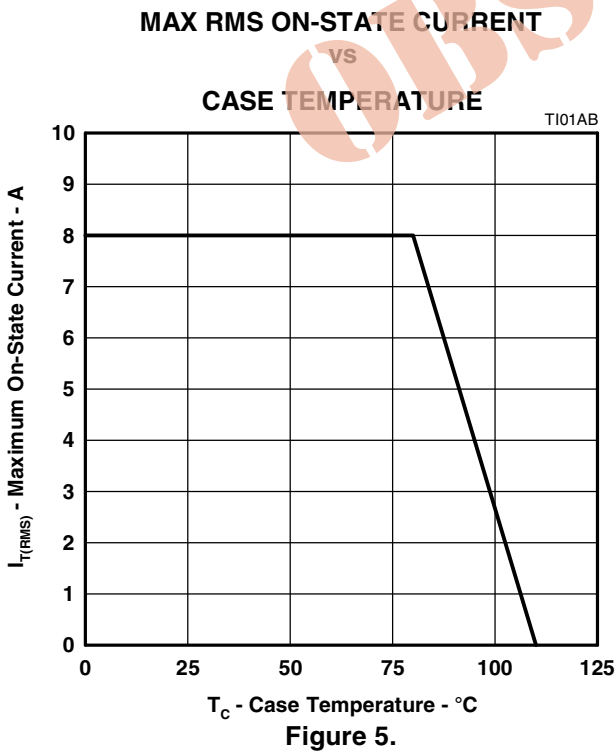

**PRODUCT INFORMATION**

APRIL 1971 - REVISED SEPTEMBER 2002  
Specifications are subject to change without notice.

**PARAMETER MEASUREMENT INFORMATION**

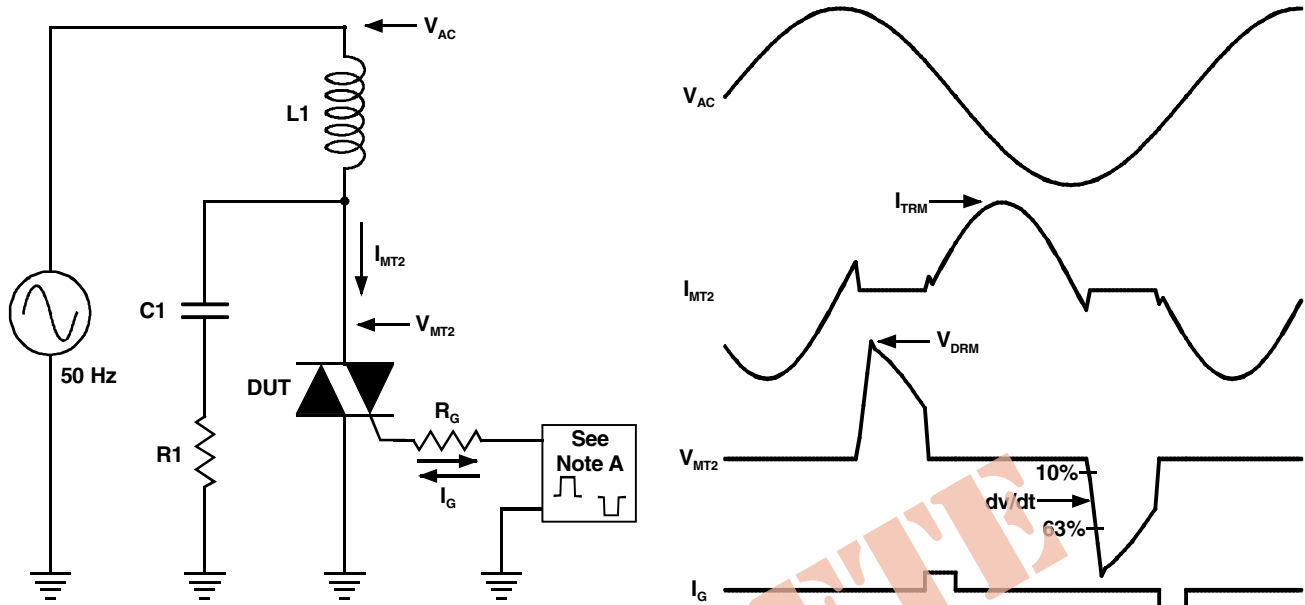

NOTE A: The gate-current pulse is furnished by a trigger circuit which presents essentially an open circuit between pulses. The pulse is timed so that the off-state-voltage duration is approximately 800  $\mu$ s.

PMC2AA

Figure 7.

**PRODUCT INFORMATION**

APRIL 1971 - REVISED SEPTEMBER 2002  
Specifications are subject to change without notice.