

DEC1X3J470JC4B

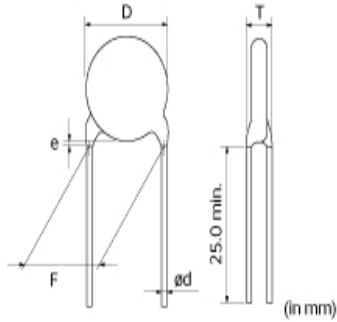

Appearance & Shape

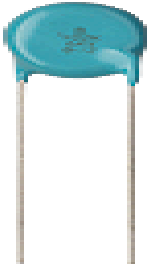

References

Packaging	Specifications	Standard Packing Quantity
B	Bulk(Bag)	250

Mass (typ.)	
1 piece	0.79g

Attention

- 1.This datasheet is downloaded from the website of Murata Manufacturing Co., Ltd. Therefore, it's specifications are subject to change or our products in it may be discontinued without advance notice. Please check with our sales representatives or product engineers before ordering.
- 2.This datasheet has only typical specifications because there is no space for detailed specifications. Therefore, please review our product specifications or consult the approval sheet for product specifications before ordering.

DEC1X3J470JC4B

Specifications

L size or Outer diameter D	9.0mm max.
T size	7.0mm max.
Lead spacing F	10.0±1.0mm
Lead diameter d	0.6±0.05mm
Paint dripping e	3.0mm max.
Capacitance	47pF ±5%
Rated voltage	6300Vdc
Temperature characteristics	SL(JIS)
Temperature range of temperature characteristics	20°C to 85°C
Operating Temperature Range	-25°C to 85°C
TC	+350 to -1000ppm/°C

Attention

1.This datasheet is downloaded from the website of Murata Manufacturing Co., Ltd. Therefore, it's specifications are subject to change or our products in it may be discontinued without advance notice. Please check with our sales representatives or product engineers before ordering.

2.This datasheet has only typical specifications because there is no space for detailed specifications.

Therefore, please review our product specifications or consult the approval sheet for product specifications before ordering.