

DE1E3KX152MA4BP01F

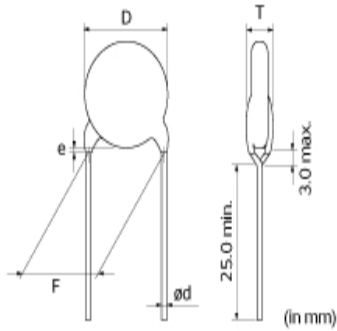

Appearance & Shape



References

Packaging	Specifications	Standard Packing Quantity
B	Bulk(Bag)	250

Mass (typ.)	
1 piece	0.43g

Notices

X1/Y1 Class Certified Products, Halogen-free Products

Attention

- 1.This datasheet is downloaded from the website of Murata Manufacturing Co., Ltd. Therefore, it's specifications are subject to change or our products in it may be discontinued without advance notice. Please check with our sales representatives or product engineers before ordering.
- 2.This datasheet has only typical specifications because there is no space for detailed specifications. Therefore, please review our product specifications or consult the approval sheet for product specifications before ordering.

DE1E3KX152MA4BP01F



Specifications

L size or Outer diameter D	8.0mm max.
T size	7.0mm max.
Lead spacing F	10.0±1.0mm
Lead diameter d	0.6±0.05mm
Paint dripping e	Up to the end of crimp
Capacitance	1500pF ±20%
Rated voltage	300Vac(r.m.s.)
Temperature characteristics	E(JIS)
Capacitance change rate	+20/-55%
Temperature range of temperature characteristics	-25°C to 85°C
Operating Temperature Range	-40°C to 125°C

Attention

1.This datasheet is downloaded from the website of Murata Manufacturing Co., Ltd. Therefore, it's specifications are subject to change or our products in it may be discontinued without advance notice. Please check with our sales representatives or product engineers before ordering.

2.This datasheet has only typical specifications because there is no space for detailed specifications.

Therefore, please review our product specifications or consult the approval sheet for product specifications before ordering.

DE1E3KX152MA4BP01F

Characteristic Data

The charts below may show another part number which shares its characteristics.

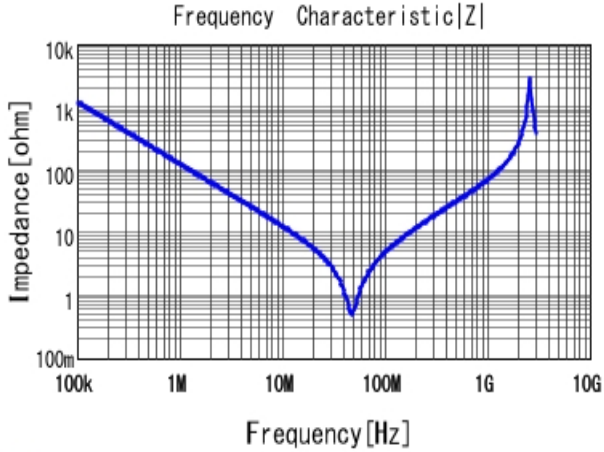

■ DE1E3KX152MA4BP01F |Z| DC0V, 20degC

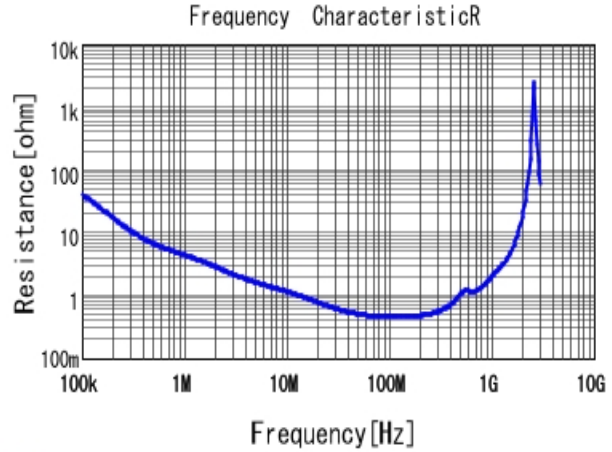

■ DE1E3KX152MA4BP01F R DC0V, 20degC

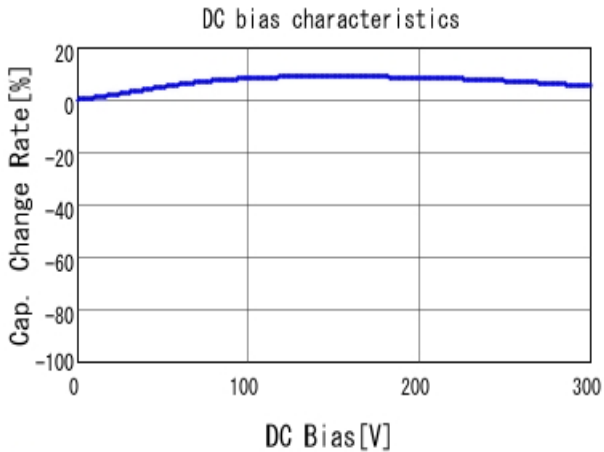

■ DE1E3KX152MA4BP01F C-DC bias capchange, 20.0degC, AC1

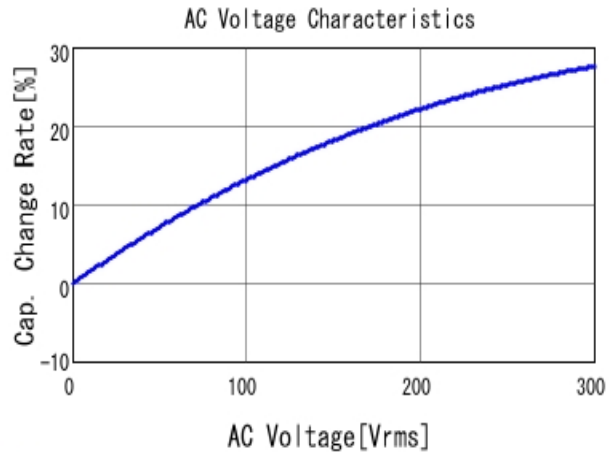

■ DE1E3KX152MA4BP01F C-AC Voltage capchange, DC0V, 20.0

Attention

- 1.This datasheet is downloaded from the website of Murata Manufacturing Co., Ltd. Therefore, it's specifications are subject to change or our products in it may be discontinued without advance notice. Please check with our sales representatives or product engineers before ordering.
- 2.This datasheet has only typical specifications because there is no space for detailed specifications. Therefore, please review our product specifications or consult the approval sheet for product specifications before ordering.

DE1E3KX152MA4BP01F

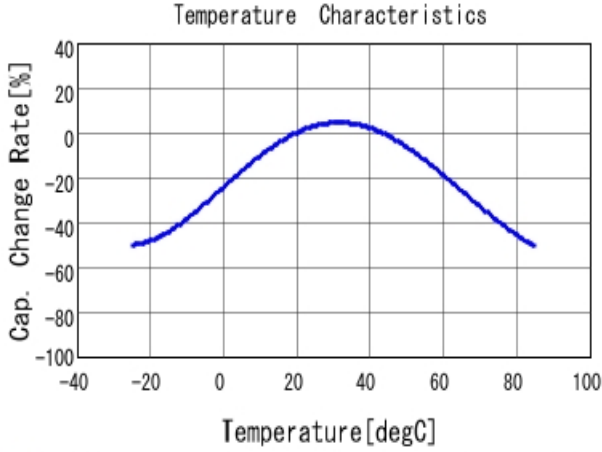

■ DE1E3KX152MA4BP01F C-Temp. capchange, DCOV, AC1Vrms

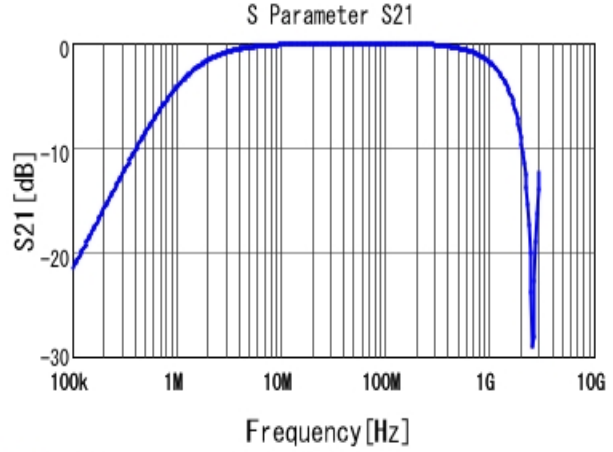

■ DE1E3KX152MA4BP01F S21 DCOV, 20degC

Attention

- 1.This datasheet is downloaded from the website of Murata Manufacturing Co., Ltd. Therefore, it's specifications are subject to change or our products in it may be discontinued without advance notice. Please check with our sales representatives or product engineers before ordering.
- 2.This datasheet has only typical specifications because there is no space for detailed specifications. Therefore, please review our product specifications or consult the approval sheet for product specifications before ordering.