

# MC33375, NCV33375 Series

## 300 mA, Low Dropout Voltage Regulator with On/Off Control

The MC33375 series are micropower low dropout voltage regulators available in a wide variety of output voltages as well as packages, SOT-223 and SOP-8. These devices feature a very low quiescent current and are capable of supplying output currents up to 300 mA. Internal current and thermal limiting protection are provided by the presence of a short circuit at the output and an internal thermal shutdown circuit.

The MC33375 has a control pin that allows a logic level signal to turn-off or turn-on the regulator output.

Due to the low input-to-output voltage differential and bias current specifications, these devices are ideally suited for battery powered computer, consumer, and industrial equipment where an extension of useful battery life is desirable.

### Features:

- Low Quiescent Current (0.3  $\mu\text{A}$  in OFF mode; 125  $\mu\text{A}$  in ON mode)
- Low Input-to-Output Voltage Differential of 25 mV at  $I_O = 10 \text{ mA}$ , and 260 mV at  $I_O = 300 \text{ mA}$
- Extremely Tight Line and Load Regulation
- Stable with Output Capacitance of only 0.33  $\mu\text{F}$  for 2.5 V Output Voltage
- Internal Current and Thermal Limiting
- Logic Level ON/OFF Control
- Pb-Free Packages are Available
- NCV Prefix for Automotive and Other Applications Requiring Site and Control Changes

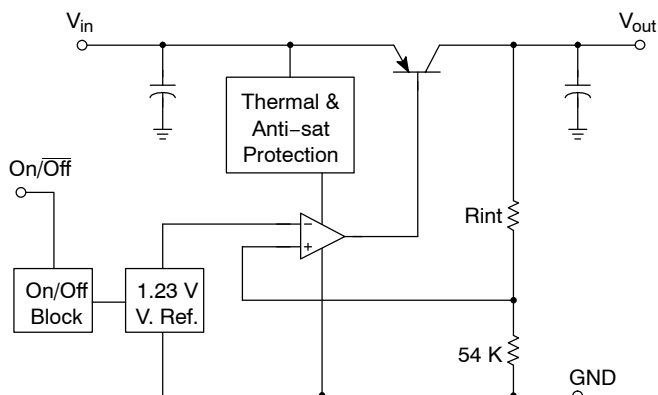

This device contains 41 active transistors

Figure 1. Simplified Block Diagram



ON Semiconductor®

<http://onsemi.com>

## LOW DROPOUT MICROPOWER VOLTAGE REGULATOR

### MARKING DIAGRAMS



SOT-223  
ST SUFFIX  
CASE 318E

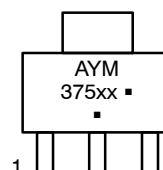

SOIC-8  
D SUFFIX  
CASE 751

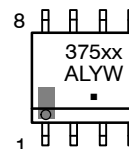

A = Assembly Location  
Y = Year  
M = Date Code  
L = Wafer Lot  
W = Work Week  
xx = Voltage Version  
▪ = Pb-Free Package

(Note: Microdot may be in either location)

### ORDERING INFORMATION

See detailed ordering and shipping information in the package dimensions section on page 11 of this data sheet.

# MC33375, NCV33375 Series

## PIN CONNECTIONS

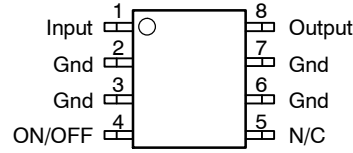
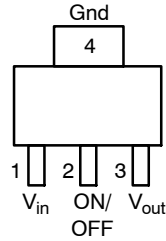

## MAXIMUM RATINGS

Rating	Symbol	Value	Unit
Input Voltage	$V_{CC}$	13	Vdc
Power Dissipation and Thermal Characteristics $T_A = 25^\circ\text{C}$			
Maximum Power Dissipation	$P_D$	Internally Limited	W
Case 751 (SOP-8) D Suffix			
Thermal Resistance, Junction-to-Ambient	$R_{\theta JA}$	160	$^\circ\text{C/W}$
Thermal Resistance, Junction-to-Case	$R_{\theta JC}$	25	$^\circ\text{C/W}$
Case 318E (SOT-223) ST Suffix			
Thermal Resistance, Junction-to-Air	$R_{\theta JA}$	245	$^\circ\text{C/W}$
Thermal Resistance, Junction-to-Case	$R_{\theta JC}$	15	$^\circ\text{C/W}$
Output Current	$I_O$	300	mA
Maximum Junction Temperature	$T_J$	150	$^\circ\text{C}$
Operating Ambient Temperature Range	$T_A$	- 40 to +125	$^\circ\text{C}$
Storage Temperature Range	$T_{stg}$	- 65 to +150	$^\circ\text{C}$

Stresses exceeding Maximum Ratings may damage the device. Maximum Ratings are stress ratings only. Functional operation above the Recommended Operating Conditions is not implied. Extended exposure to stresses above the Recommended Operating Conditions may affect device reliability.

## MC33375, NCV33375 Series

**ELECTRICAL CHARACTERISTICS** ( $C_L = 1.0 \mu\text{F}$ ,  $T_A = 25^\circ\text{C}$ , for min/max values  $T_J = -40^\circ\text{C}$  to  $+125^\circ\text{C}$ , Note 1)

Characteristic	Symbol	Min	Typ	Max	Unit
Output Voltage $I_O = 0 \text{ mA to } 250 \text{ mA}$ 1.8 V Suffix $T_A = 25^\circ\text{C}$ , $V_{in} = [V_O + 1] \text{ V}$ 2.5 V Suffix 3.0 V Suffix 3.3 V Suffix 5.0 V Suffix  1.8 V Suffix $V_{in} = [V_O + 1] \text{ V}$ , $0 < I_O < 100 \text{ mA}$ 2.5 V Suffix 2% Tolerance from $T_J = -40$ to $+125^\circ\text{C}$ 3.0 V Suffix 3.3 V Suffix 5.0 V Suffix	$V_O$	1.782 2.475 2.970 3.267 4.950  1.764 2.450 2.940 3.234 4.900	1.80 2.50 3.00 3.30 5.00  – – – – –	1.818 2.525 3.030 3.333 5.05  1.836 2.550 3.060 3.366 5.100	Vdc
Line Regulation $V_{in} = [V_O + 1] \text{ V to } 12 \text{ V}$ , $I_O = 250 \text{ mA}$ , All Suffixes $T_A = 25^\circ\text{C}$	$\text{Reg}_{line}$	–	2.0	10	mV
Load Regulation $V_{in} = [V_O + 1] \text{ V}$ , $I_O = 0 \text{ mA to } 250 \text{ mA}$ , All Suffixes $T_A = 25^\circ\text{C}$	$\text{Reg}_{load}$	–	5.0	25	mV
Dropout Voltage (Note 3) $I_O = 10 \text{ mA}$ $T_J = -40^\circ\text{C to } +125^\circ\text{C}$ $I_O = 100 \text{ mA}$ $I_O = 250 \text{ mA}$ $I_O = 300 \text{ mA}$	$V_{in} - V_O$	– – – –	25 115 220 260	100 200 400 500	mV
Ripple Rejection (120 Hz) $V_{in(\text{peak-peak})} = [V_O + 1.5] \text{ V to } [V_O + 5.5] \text{ V}$	–	65	75	–	dB
Output Noise Voltage $C_L = 1.0 \mu\text{F}$ $I_O = 50 \text{ mA}$ (10 Hz to 100 kHz) $C_L = 200 \mu\text{F}$	$V_n$	– –	160 46	– –	$\mu\text{Vrms}$

### CURRENT PARAMETERS

Quiescent Current ON Mode $V_{in} = [V_O + 1] \text{ V}$ , $I_O = 0 \text{ mA}$	$I_{QON}$	–	125	200	$\mu\text{A}$
Quiescent Current OFF Mode	$I_{QOFF}$	–	0.3	4.0	$\mu\text{A}$
Quiescent Current ON Mode SAT $V_{in} = [V_O - 0.5] \text{ V}$ , $I_O = 0 \text{ mA}$ (Note 2) 1.8 V Suffix 2.5 V Suffix 3.0 V Suffix 3.3 V Suffix 5.0 V Suffix	$I_{QSAT}$	– – – – –	1100 1100 1500 1500 1500	1500 1500 2000 2000 2000	$\mu\text{A}$
Current Limit $V_{in} = [V_O + 1] \text{ V}$ , $V_O$ Shorted	$I_{LIMIT}$	–	450	–	mA

### ON/OFF INPUTS

On/Off Input Voltage Logic "1" (Regulator On) $V_{out} = V_O \pm 2\%$ Logic "0" (Regulator Off) $V_{out} < 0.03 \text{ V}$ Logic "0" (Regulator Off) $V_{out} < 0.05 \text{ V}$ (1.8 V Option)	$V_{CTRL}$	2.4 – –	– – –	– 0.5 0.3	V
---	------------	---------------	-------------	-----------------	---

### THERMAL SHUTDOWN

Thermal Shutdown	–	–	150	–	$^\circ\text{C}$
------------------	---	---	-----	---	------------------

- Low duty pulse techniques are used during test to maintain junction temperature as close to ambient as possible.
- Quiescent Current is measured where the PNP pass transistor is in saturation.  $V_{in} = [V_O - 0.5] \text{ V}$  guarantees this condition.
- For 1.8 V version  $V_{DO}$  is constrained by the minimum input voltage of 2.5 V.

## DEFINITIONS

**Load Regulation** – The change in output voltage for a change in load current at constant chip temperature.

**Dropout Voltage** – The input/output differential at which the regulator output no longer maintains regulation against further reductions in input voltage. Measured when the output drops 100 mV below its nominal value (which is measured at 1.0 V differential), dropout voltage is affected by junction temperature, load current and minimum input supply requirements.

**Output Noise Voltage** – The RMS AC voltage at the output with a constant load and no input ripple, measured over a specified frequency range.

**Maximum Power Dissipation** – The maximum total dissipation for which the regulator will operate within specifications.

**Quiescent Current** – Current which is used to operate the regulator chip and is not delivered to the load.

**Line Regulation** – The change in output voltage for a change in the input voltage. The measurement is made under conditions of low dissipation or by using pulse techniques such that the average chip temperature is not significantly affected.

**Maximum Package Power Dissipation** – The maximum package power dissipation is the power dissipation level at which the junction temperature reaches its maximum value i.e. 150°C. The junction temperature is rising while the

difference between the input power ( $V_{CC} \times I_{CC}$ ) and the output power ( $V_{out} \times I_{out}$ ) is increasing.

Depending on ambient temperature, it is possible to calculate the maximum power dissipation and so the maximum current as following:

$$P_d = \frac{T_J - T_A}{R_{\theta JA}}$$

The maximum operating junction temperature  $T_J$  is specified at 150°C, if  $T_A = 25^\circ\text{C}$ , then  $P_D$  can be found. By neglecting the quiescent current, the maximum power dissipation can be expressed as:

$$I_{out} = \frac{P_D}{V_{CC} - V_{out}}$$

The thermal resistance of the whole circuit can be evaluated by deliberately activating the thermal shutdown of the circuit (by increasing the output current or raising the input voltage for example).

Then you can calculate the power dissipation by subtracting the output power from the input power. All variables are then well known: power dissipation, thermal shutdown temperature (150°C for MC33375) and ambient temperature.

$$R_{\theta JA} = \frac{T_J - T_A}{P_D}$$

# MC33375, NCV33375 Series

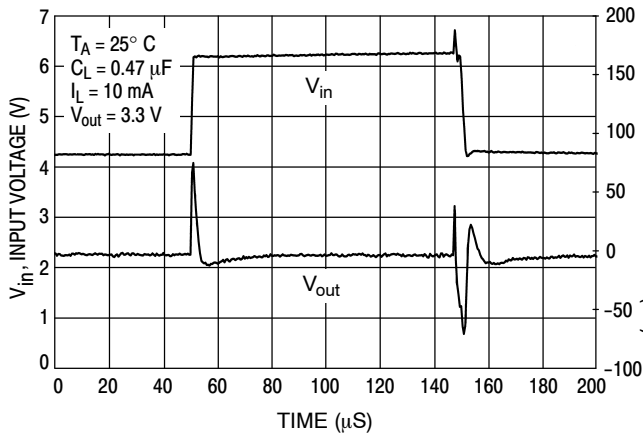

Figure 2. Line Transient Response

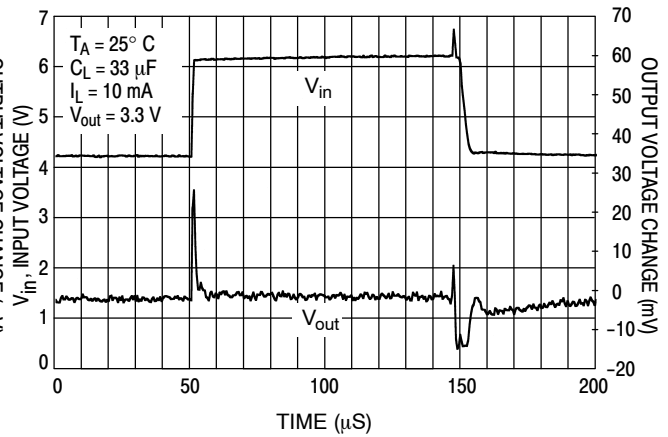

Figure 3. Line Transient Response

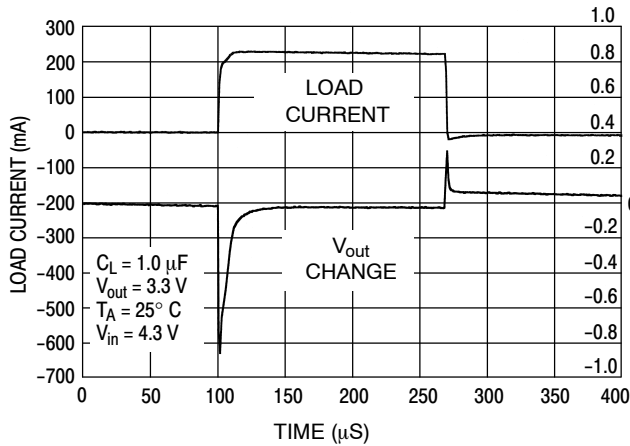

Figure 4. Load Transient Response

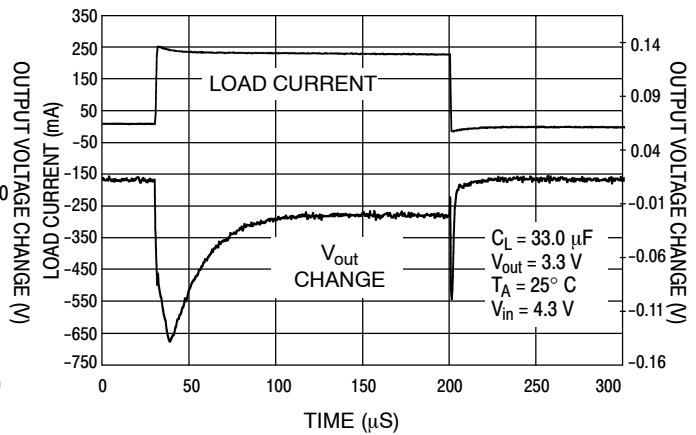

Figure 5. Load Transient Response

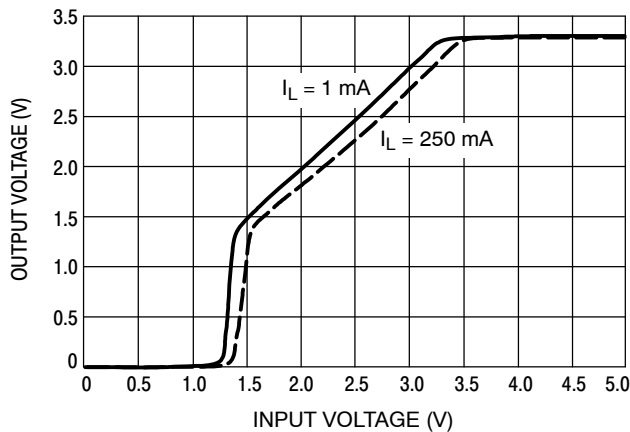

Figure 6. Output Voltage versus Input Voltage

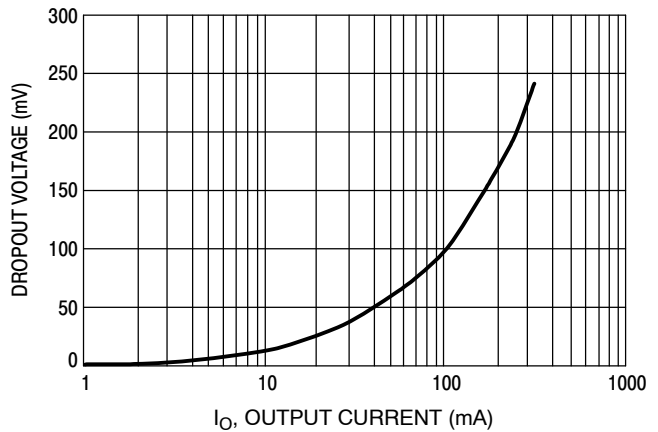

Figure 7. Dropout Voltage versus Output Current

# MC33375, NCV33375 Series

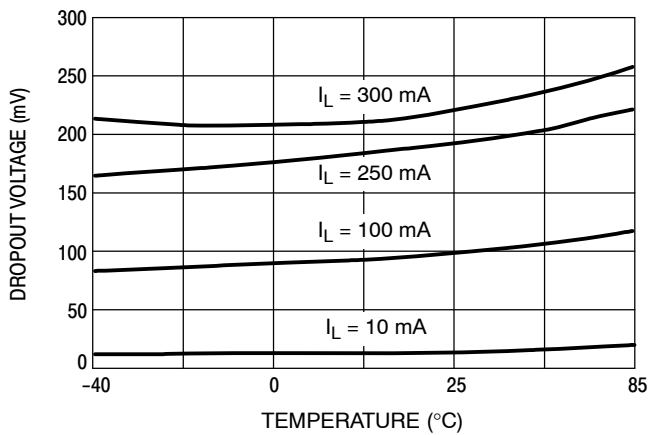

Figure 8. Dropout Voltage versus Temperature

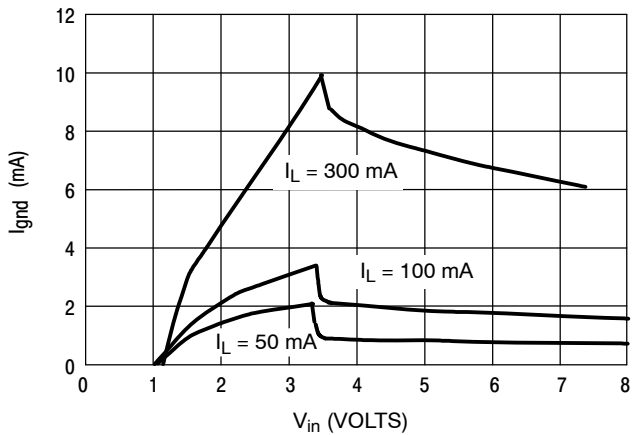

Figure 9. Ground Pin Current versus Input Voltage

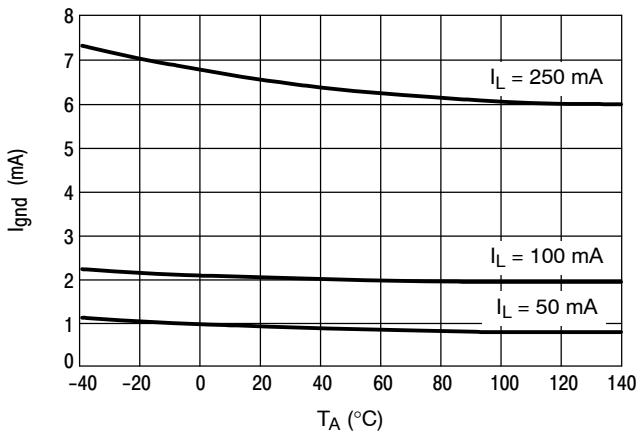

Figure 10. Ground Pin Current versus Ambient Temperature

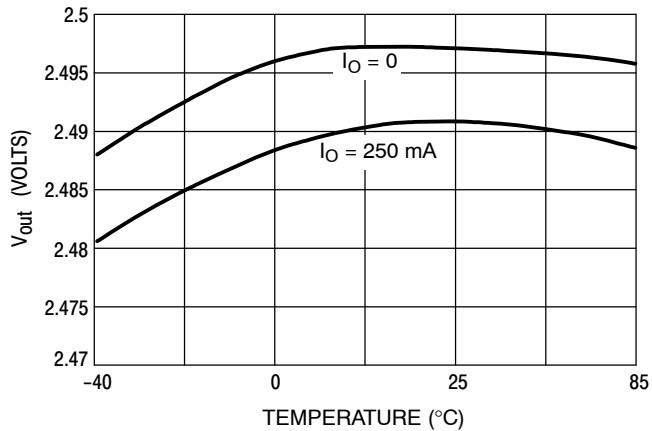
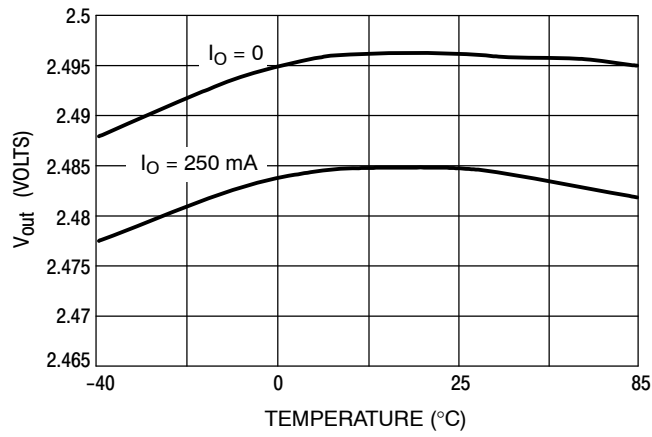
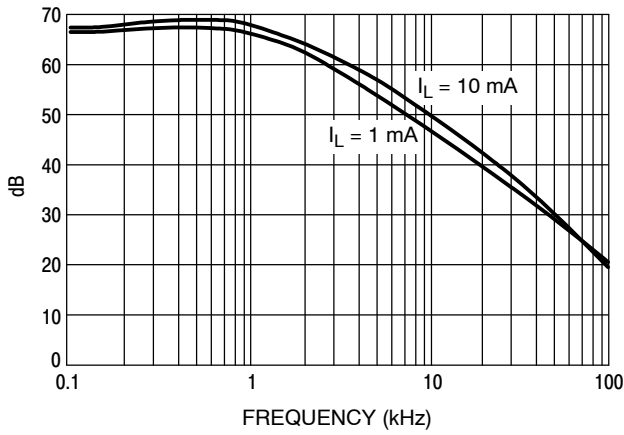

Figure 11. Output Voltage versus Ambient Temperature ( $V_{in} = V_{out} + 1V$ )

# MC33375, NCV33375 Series



**Figure 12. Output Voltage versus Ambient Temperature ( $V_{in} = 12\text{ V}$ )**



**Figure 13. Ripple Rejection**

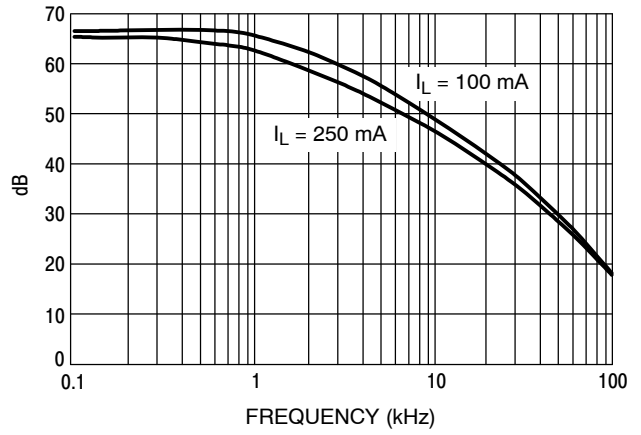

**Figure 14. Ripple Rejection**

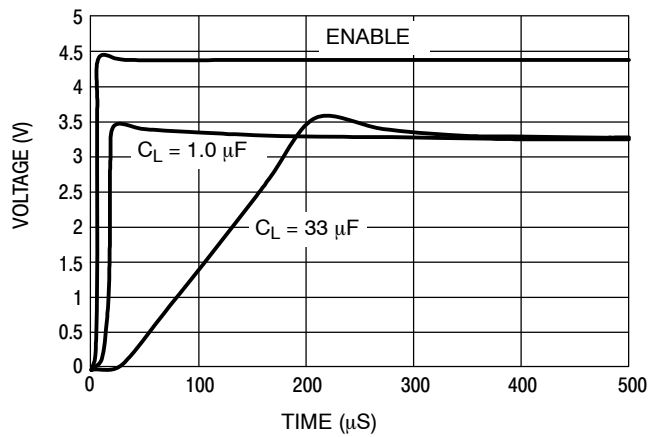

**Figure 15. Enable Transient**

# MC33375, NCV33375 Series

## 1.8 V Option

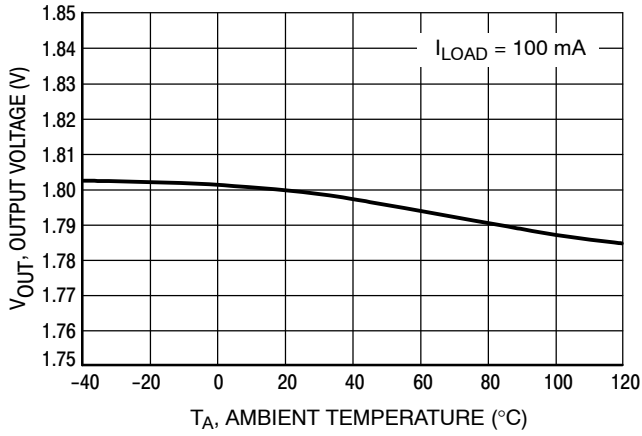

Figure 16. Output Voltage versus Temperature

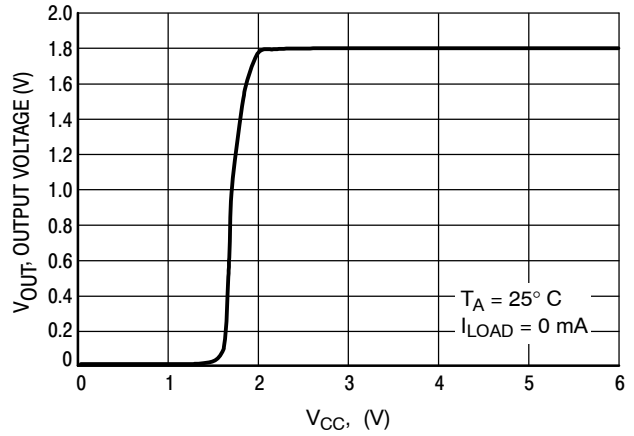

Figure 17. Output Voltage versus Input Voltage

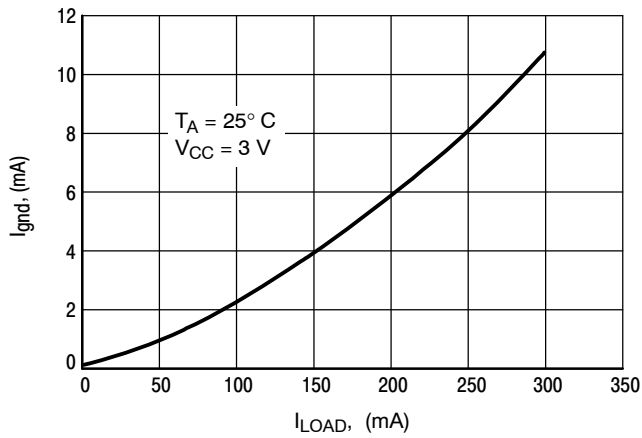

Figure 18. Ground Current versus Load Current

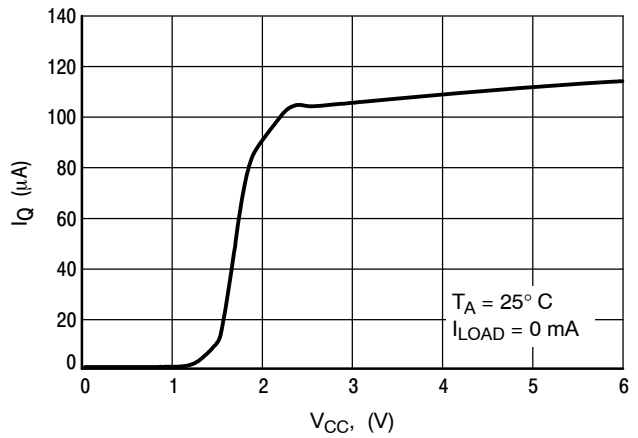

Figure 19. Quiescent Current versus Input Voltage

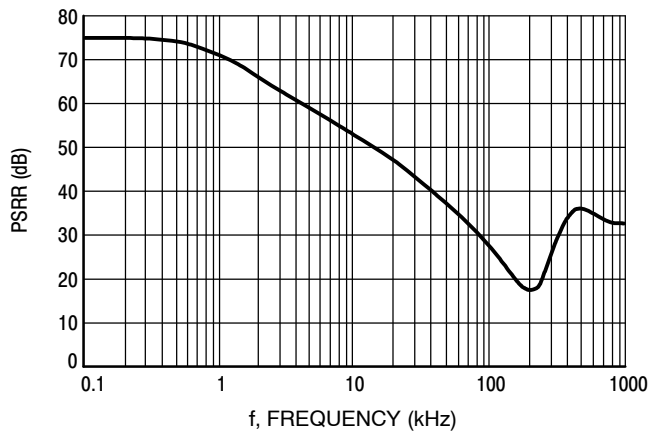

Figure 20. PSRR versus Frequency

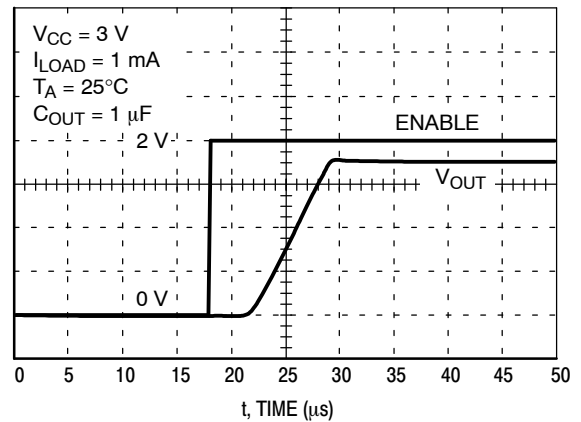

Figure 21. Enable Response



## MC33375, NCV33375 Series

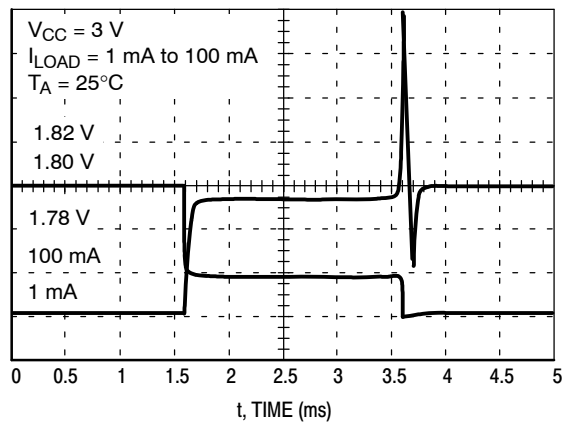

Figure 22. Load Transient Response

### APPLICATIONS INFORMATION

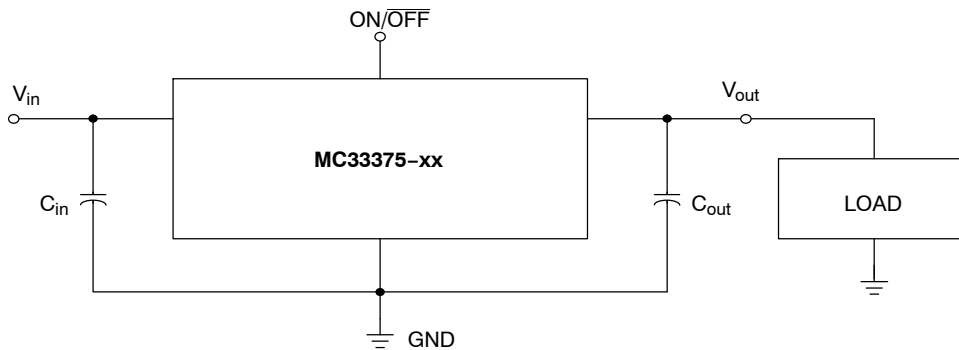

Figure 23. Typical Application Circuit

The MC33375 regulators are designed with internal current limiting and thermal shutdown making them user-friendly. Figure 15 is a typical application circuit. The output capability of the regulator is in excess of 300 mA, with a typical dropout voltage of less than 260 mV. Internal protective features include current and thermal limiting.

#### EXTERNAL CAPACITORS

These regulators require only a 0.33  $\mu\text{F}$  (or greater) capacitance between the output and ground for stability for 1.8 V, 2.5 V, 3.0 V, and 3.3 V output voltage options. Output voltage options of 5.0 V require only 0.22  $\mu\text{F}$  for stability. The output capacitor must be mounted as close as possible to the MC33375. If the output capacitor must be mounted further than two centimeters away from the MC33375, then a larger value of output capacitor may be required for stability. A value of 0.68  $\mu\text{F}$  or larger is recommended. Most type of aluminum, tantalum, or multilayer ceramic will perform adequately. Solid tantalums or appropriate multilayer ceramic capacitors are recommended for operation below 25°C. An input bypass capacitor is recommended to improve transient response or if the regulator is connected to the supply input filter with long wire lengths, more than 4 inches. This will reduce the circuit's sensitivity to the input line impedance at high

frequencies. A 0.33  $\mu\text{F}$  or larger tantalum, mylar, ceramic, or other capacitor having low internal impedance at high frequencies should be chosen. The bypass capacitor should be mounted with shortest possible lead or track length directly across the regulator's input terminals. Figure 16 shows the ESR that allows the LDO to remain stable for various load currents.

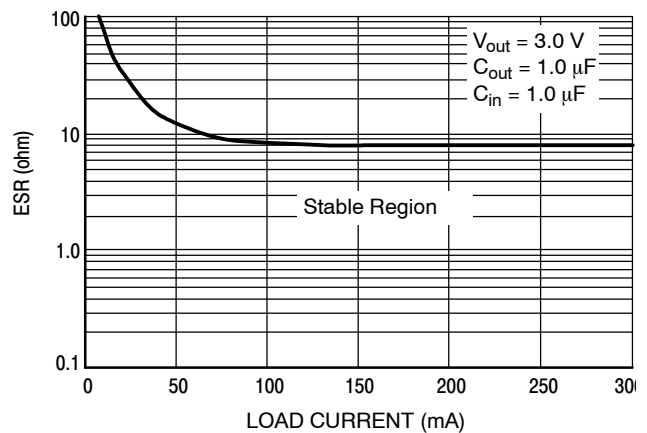

Figure 24. ESR for  $V_{out} = 3.0\text{V}$

Applications should be tested over all operating conditions to insure stability.

## MC33375, NCV33375 Series

### THERMAL PROTECTION

Internal thermal limiting circuitry is provided to protect the integrated circuit in the event that the maximum junction temperature is exceeded. When activated, typically at 150°C, the output is disabled. There is no hysteresis built into the thermal protection. As a result the output will appear to be oscillating during thermal limit. The output will turn off until the temperature drops below the 150°C then the output turns on again. The process will repeat if the junction increases above the threshold. This will continue until the existing conditions allow the junction to operate below the temperature threshold.

**Thermal limit is not a substitute for proper heatsinking.**

The internal current limit will typically limit current to 450 mA. If during current limit the junction exceeds 150°C, the thermal protection will protect the device also. **Current limit is not a substitute for proper heatsinking.**

### OUTPUT NOISE

In many applications it is desirable to reduce the noise present at the output. Reducing the regulator bandwidth by increasing the size of the output capacitor will reduce the noise on the MC33375.

### ON/OFF PIN

When this pin is pulled low, the MC33375 is off. This pin should not be left floating. The pin should be pulled high for the MC33375 to operate.

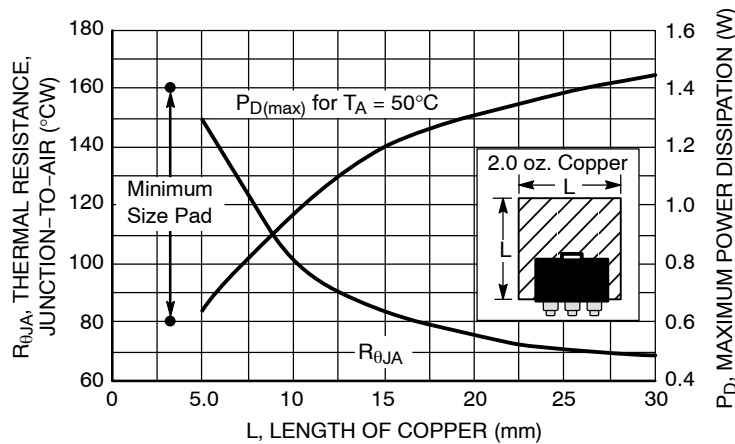

Figure 25. SOT-223 Thermal Resistance and Maximum Power Dissipation versus P.C.B. Copper Length

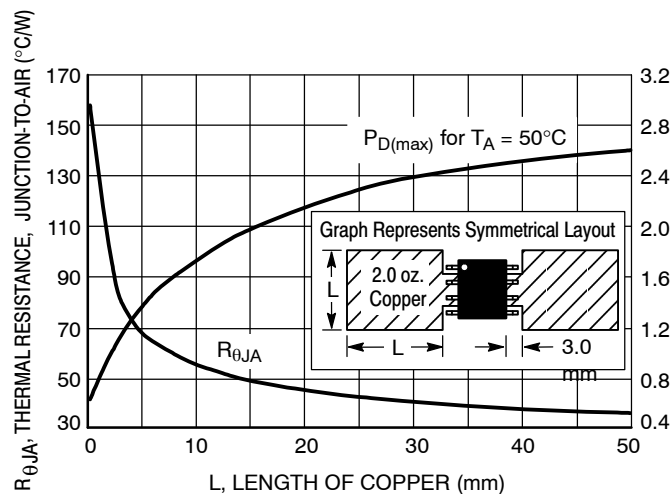

Figure 26. SOP-8 Thermal Resistance and Maximum Power Dissipation versus P.C.B. Copper Length

## MC33375, NCV33375 Series

### ORDERING INFORMATION

Device	Type	Operating Temperature Range, Tolerance	Package	Shipping <sup>†</sup>	
MC33375ST-1.8T3	1.8 V (Fixed Voltage)	1% Tolerance at T <sub>A</sub> = 25°C  2% Tolerance at T <sub>J</sub> from -40 to +125°C	SOT-223	4000 / Tape & Reel	
MC33375ST-1.8T3G			SOT-223 (Pb-Free)		
NCV33375ST1.8T3G*					
MC33375D-2.5	2.5 V (Fixed Voltage)			SOIC-8	98 Units / Rail
MC33375D-2.5G			SOIC-8 (Pb-Free)		
MC33375D-2.5R2			SOIC-8	2500 / Tape & Reel	
MC33375D-2.5R2G			SOIC-8 (Pb-Free)		
NCV33375D-2.5R2G*					
MC33375ST-2.5T3			SOT-223	4000 / Tape & Reel	
MC33375ST-2.5T3G			SOT-223 (Pb-Free)		
MC33375D-3.0	3.0 V (Fixed Voltage)			SOIC-8	98 Units / Rail
MC33375D-3.0G			SOIC-8 (Pb-Free)		
MC33375D-3.0R2			SOIC-8	2500 / Tape & Reel	
MC33375D-3.0R2G			SOIC-8 (Pb-Free)		
MC33375ST-3.0T3			SOT-223	4000 / Tape & Reel	
MC33375ST-3.0T3G			SOT-223 (Pb-Free)		
MC33375D-3.3	3.3 V (Fixed Voltage)			SOIC-8	98 Units / Rail
MC33375D-3.3G			SOIC-8 (Pb-Free)		
MC33375D-3.3R2		SOIC-8	2500 / Tape & Reel		
MC33375D-3.3R2G		SOIC-8 (Pb-Free)			
NCV33375D-3.3R2G*					
MC33375ST-3.3T3		SOT-223	4000 / Tape & Reel		
MC33375ST-3.3T3G		SOT-223 (Pb-Free)			
NCV33375ST3.3T3G*					
MC33375D-5.0	5.0 V (Fixed Voltage)		SOIC-8	98 Units / Rail	
MC33375D-5.0G		SOIC-8 (Pb-Free)			
MC33375D-5.0R2		SOIC-8	2500 / Tape & Reel		
MC33375D-5.0R2G		SOIC-8 (Pb-Free)			
MC33375ST-5.0T3		SOT-223	4000 / Tape & Reel		
MC33375ST-5.0T3G		SOT-223 (Pb-Free)			

<sup>†</sup>For information on tape and reel specifications, including part orientation and tape sizes, please refer to our Tape and Reel Packaging Specifications Brochure, BRD8011/D.

\*NCV prefix for automotive and other applications requiring site and change controls.

## MC33375, NCV33375 Series

### DEVICE MARKING

Device	Version	Marking (1st line)
MC33375, NCV33375	1.8 V	37518
MC33375, NCV33375	2.5 V	37525
MC33375	3.0 V	37530
MC33375, NCV33375	3.3 V	37533
MC33375	5.0 V	37550

### TAPE AND REEL SPECIFICATIONS†

Device	Reel Size	Tape Width	Quantity
MC33375D, NCV33375D	13"	12 mm Embossed Tape	2500 Units
MC33375ST, NCV33375ST	13"	8 mm Embossed Tape	4000 Units

†For information on tape and reel specifications, including part orientation and tape sizes, please refer to our Tape and Reel Packaging Specifications Brochure, BRD8011/D.

# MC33375, NCV33375 Series

## PACKAGE DIMENSIONS

SOT-223 (TO-261)  
CASE 318E-04  
ISSUE N

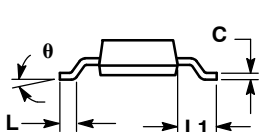
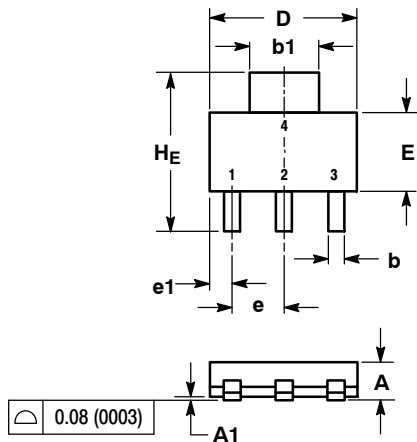

NOTES:  
1. DIMENSIONING AND TOLERANCING PER ASME Y14.5M, 1994.  
2. CONTROLLING DIMENSION: INCH.

DIM	MILLIMETERS			INCHES		
	MIN	NOM	MAX	MIN	NOM	MAX
A	1.50	1.63	1.75	0.060	0.064	0.068
A1	0.02	0.06	0.10	0.001	0.002	0.004
b	0.60	0.75	0.89	0.024	0.030	0.035
b1	2.90	3.06	3.20	0.115	0.121	0.126
c	0.24	0.29	0.35	0.009	0.012	0.014
D	6.30	6.50	6.70	0.249	0.256	0.263
E	3.30	3.50	3.70	0.130	0.138	0.145
e	2.20	2.30	2.40	0.087	0.091	0.094
e1	0.85	0.94	1.05	0.033	0.037	0.041
L	0.20	---	---	0.008	---	---
L1	1.50	1.75	2.00	0.060	0.069	0.078
HE	6.70	7.00	7.30	0.264	0.276	0.287
θ	0°	---	10°	0°	---	10°

### SOLDERING FOOTPRINT\*

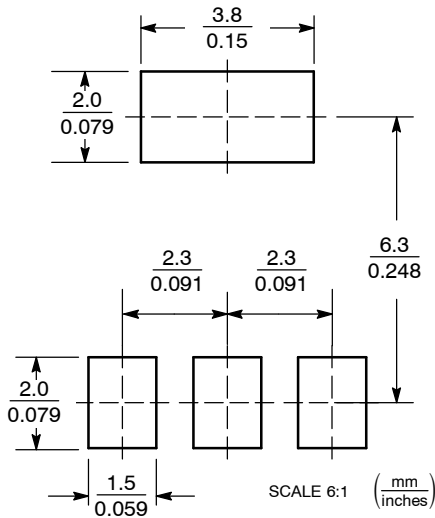

\*For additional information on our Pb-Free strategy and soldering details, please download the ON Semiconductor Soldering and Mounting Techniques Reference Manual, SOLDERRM/D.

# MC33375, NCV33375 Series

## PACKAGE DIMENSIONS

SOIC-8 NB  
CASE 751-07  
ISSUE AK

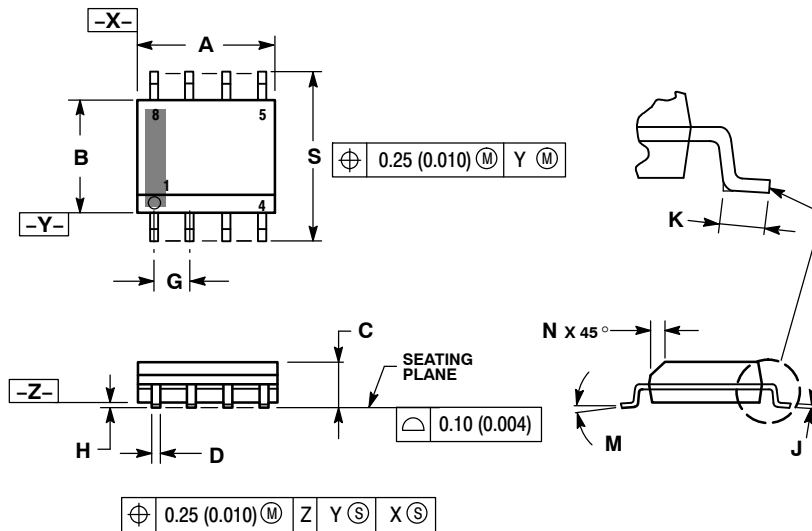

NOTES:

1. DIMENSIONING AND TOLERANCING PER ANSI Y14.5M, 1982.
2. CONTROLLING DIMENSION: MILLIMETER.
3. DIMENSION A AND B DO NOT INCLUDE MOLD PROTRUSION.
4. MAXIMUM MOLD PROTRUSION 0.15 (0.006) PER SIDE.
5. DIMENSION D DOES NOT INCLUDE DAMBAR PROTRUSION. ALLOWABLE DAMBAR PROTRUSION SHALL BE 0.127 (0.005) TOTAL IN EXCESS OF THE D DIMENSION AT MAXIMUM MATERIAL CONDITION.
6. 751-01 THRU 751-06 ARE OBSOLETE. NEW STANDARD IS 751-07.

DIM	MILLIMETERS		INCHES	
	MIN	MAX	MIN	MAX
A	4.80	5.00	0.189	0.197
B	3.80	4.00	0.150	0.157
C	1.35	1.75	0.053	0.069
D	0.33	0.51	0.013	0.020
G	1.27 BSC		0.050 BSC	
H	0.10	0.25	0.004	0.010
J	0.19	0.25	0.007	0.010
K	0.40	1.27	0.016	0.050
M	0° - 8°		0° - 8°	
N	0.25	0.50	0.010	0.020
S	5.80	6.20	0.228	0.244

### SOLDERING FOOTPRINT\*

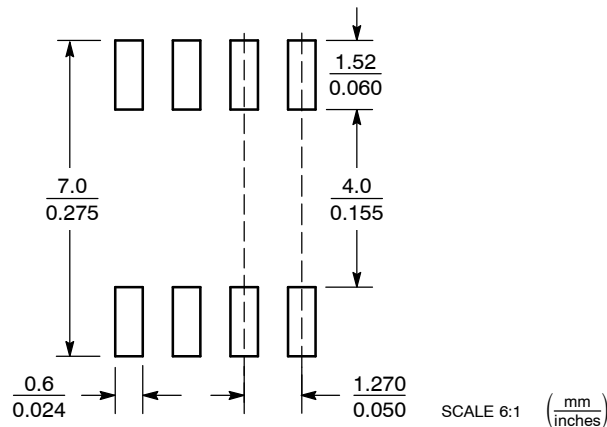

\*For additional information on our Pb-Free strategy and soldering details, please download the ON Semiconductor Soldering and Mounting Techniques Reference Manual, SOLDERRM/D.

ON Semiconductor and are registered trademarks of Semiconductor Components Industries, LLC (SCILLC). SCILLC owns the rights to a number of patents, trademarks, copyrights, trade secrets, and other intellectual property. A listing of SCILLC's product/patent coverage may be accessed at [www.onsemi.com/site/pdf/Patent-Marking.pdf](http://www.onsemi.com/site/pdf/Patent-Marking.pdf). SCILLC reserves the right to make changes without further notice to any products herein. SCILLC makes no warranty, representation or guarantee regarding the suitability of its products for any particular purpose, nor does SCILLC assume any liability arising out of the application or use of any product or circuit, and specifically disclaims any and all liability, including without limitation special, consequential or incidental damages. "Typical" parameters which may be provided in SCILLC data sheets and/or specifications can and do vary in different applications and actual performance may vary over time. All operating parameters, including "Typicals" must be validated for each customer application by customer's technical experts. SCILLC does not convey any license under its patent rights nor the rights of others. SCILLC products are not designed, intended, or authorized for use as components in systems intended for surgical implant into the body, or other applications intended to support or sustain life, or for any other application in which the failure of the SCILLC product could create a situation where personal injury or death may occur. Should Buyer purchase or use SCILLC products for any such unintended or unauthorized application, Buyer shall indemnify and hold SCILLC and its officers, employees, subsidiaries, affiliates, and distributors harmless against all claims, costs, damages, and expenses, and reasonable attorney fees arising out of, directly or indirectly, any claim of personal injury or death associated with such unintended or unauthorized use, even if such claim alleges that SCILLC was negligent regarding the design or manufacture of the part. SCILLC is an Equal Opportunity/Affirmative Action Employer. This literature is subject to all applicable copyright laws and is not for resale in any manner.

### PUBLICATION ORDERING INFORMATION

**LITERATURE FULFILLMENT:**  
Literature Distribution Center for ON Semiconductor  
P.O. Box 5163, Denver, Colorado 80217 USA  
Phone: 303-675-2175 or 800-344-3860 Toll Free USA/Canada  
Fax: 303-675-2176 or 800-344-3867 Toll Free USA/Canada  
Email: [orderlit@onsemi.com](mailto:orderlit@onsemi.com)

**N. American Technical Support:** 800-282-9855 Toll Free  
USA/Canada  
**Europe, Middle East and Africa Technical Support:**  
Phone: 421 33 790 2910  
**Japan Customer Focus Center**  
Phone: 81-3-5817-1050

**ON Semiconductor Website:** [www.onsemi.com](http://www.onsemi.com)  
**Order Literature:** <http://www.onsemi.com/orderlit>

For additional information, please contact your local Sales Representative

MC33375/D