

LC-P0612P

DIMENSIONS (MM)

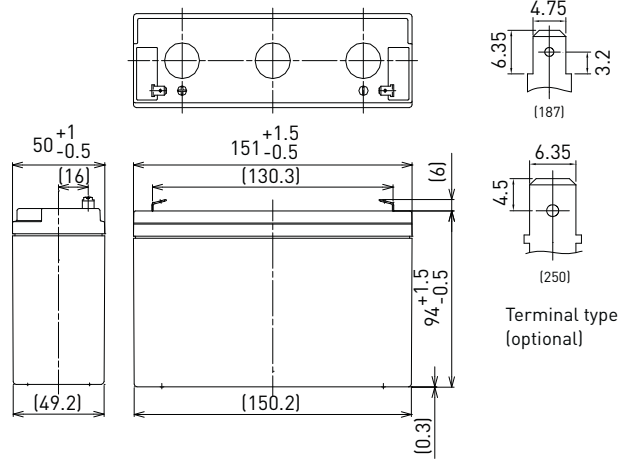

FOR STANDBY POWER SUPPLIES.
EXPECTED TRICKLE DESIGN LIFE: 10 - 12 YEARS AT 20°C
ACCORDING TO EUROBAT.



Contents indicated (including the recycle marking, etc.) are subject to change without notice.

Battery case resin: flame retardant (UL94 V-0)

SPECIFICATIONS		LC-P0612P/P1
Name		LC-P0612P/P1
Nominal voltage		6V
Nominal capacity (20 hour rate)		12Ah
Dimensions	Length	151mm
	Width	50mm
	Height	100mm
Approx. mass		1.80kg
Terminal		Faston 187/250
Capacity (25°C)	20 hour rate	12.0Ah
	10 hour rate	11.0Ah
	3 hour rate	9.3Ah
	1 hour rate	8.5Ah
Impedance	Fully charged battery (25°C)	11mΩ
	Temperature dependency of capacity (20 hour rate)	
	40°C	102%
	25°C	100%
	0°C	85%
	-15°C	65%
Remaining capacity (25°C)	After 3 month	91%
	After 6 month	82%
	After 12 month	64%

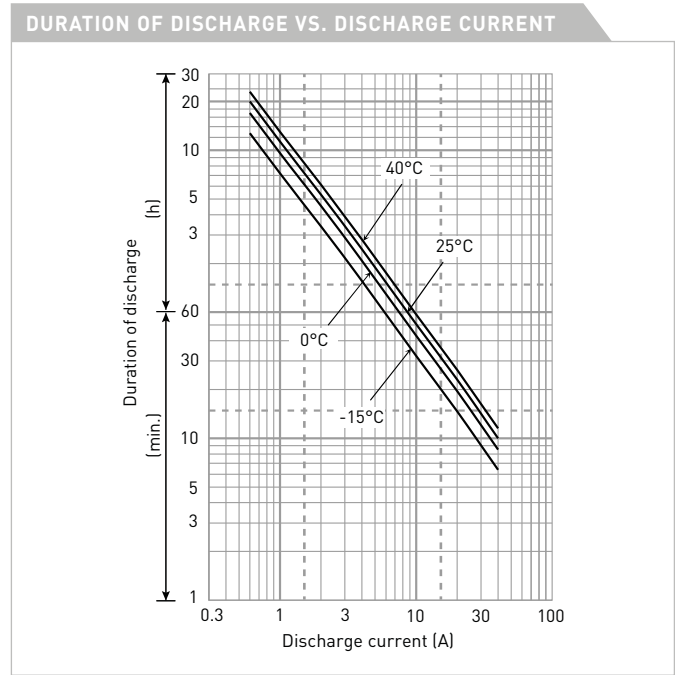

WATT TABLE (25°C)														[Wattage/battery]		
Cut-off	3min.	5min.	10min.	15min.	20min.	30min.	45min.	1h	1.5h	2h	3h	4h	5h	6h	10h	20h
4.8V	340	279	192	149	124	91.3	68.7	52.4	35.1	27.2	19.0	14.4	12.0	10.9	6.66	3.61
4.95V	325	269	186	144	121	88.3	67.5	51.8	35.0	27.1	18.9	14.4	12.0	10.9	6.66	3.61
5.1V	304	253	181	141	118	88.3	66.9	51.2	34.5	26.9	18.7	14.4	12.0	10.8	6.60	3.61
5.25V	278	237	171	136	115	86.0	66.3	50.1	34.2	26.6	18.4	14.3	12.0	10.8	6.60	3.60
5.4V	247	217	161	131	113	83.1	61.6	48.9	33.1	26.0	18.1	14.2	11.9	10.7	6.54	3.59

AMPERE TABLE (25°C)														[Ampere/battery]		
Cut-off	3min.	5min.	10min.	15min.	20min.	30min.	45min.	1h	1.5h	2h	3h	4h	5h	6h	10h	20h
4.8V	61.1	50.1	34.3	25.9	21.3	15.6	11.7	8.90	5.95	4.60	3.20	2.41	2.01	1.81	1.11	0.602
4.95V	58.4	48.2	33.3	25.0	20.8	15.1	11.5	8.80	5.92	4.58	3.18	2.41	2.01	1.81	1.11	0.602
5.1V	54.6	45.4	32.4	24.5	20.3	15.1	11.4	8.70	5.85	4.55	3.15	2.41	2.00	1.80	1.10	0.601
5.25V	50.0	42.6	30.6	23.6	19.9	14.7	11.3	8.50	5.80	4.50	3.10	2.40	2.00	1.80	1.10	0.600
5.4V	44.5	38.9	28.7	22.7	19.4	14.2	10.5	8.30	5.60	4.40	3.05	2.38	1.99	1.79	1.09	0.598

All mentioned values are average values

LC-P0612P

CHARGING METHOD (25°C)

Trickle use Control voltage: 6.8V - 6.9V
Initial current: 1.8A or smaller

CUT-OFF VOLTAGE

Discharge current	0.6A - 2.4A	2.4A - 6A	6A - 12A	12A - 24A	24A - 36A
Cut-off voltage	5.25V	5.10V	4.95V	4.65V	4.35V

INFLUENCE OF TEMPERATURE ON TRICKLE LIFE

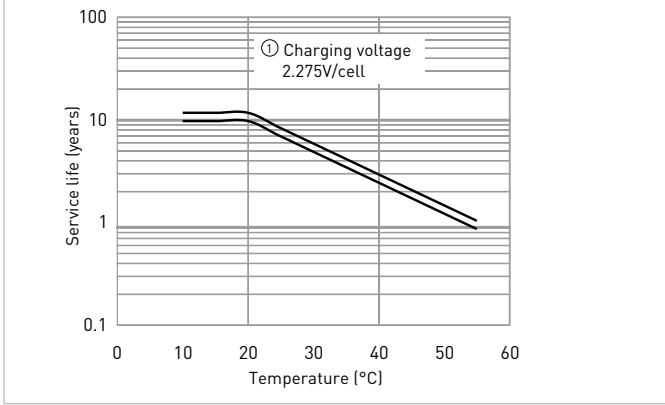

RESIDUAL CAPACITY VS. STORAGE PERIOD

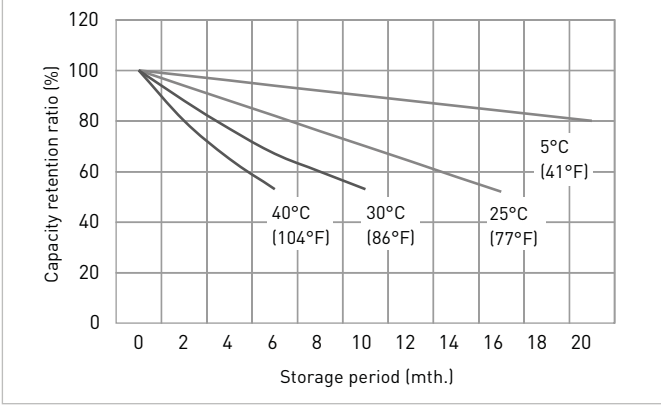

CONSTANT-VOLTAGE CONSTANT-CURRENT CHARGE CHARACTERISTICS FOR TRICKLE USE

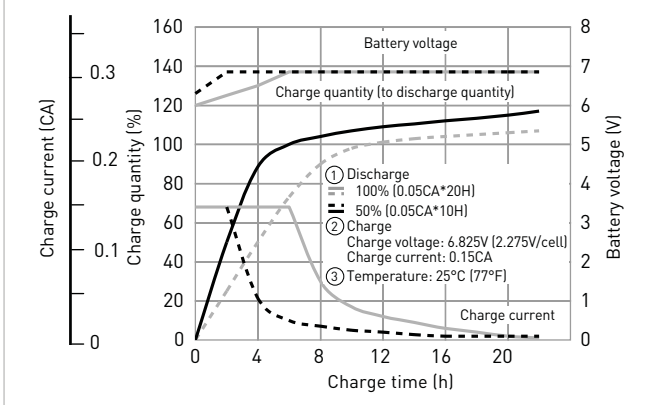

DISCHARGE CAPACITY BY TEMPERATURE AND BY DISCHARGE CURRENT

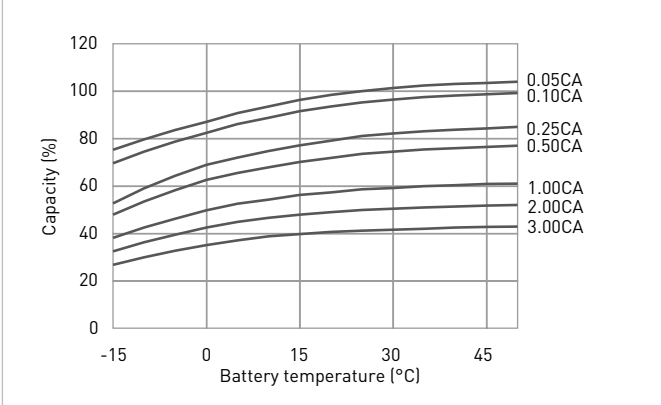

DISCHARGE CHARACTERISTICS

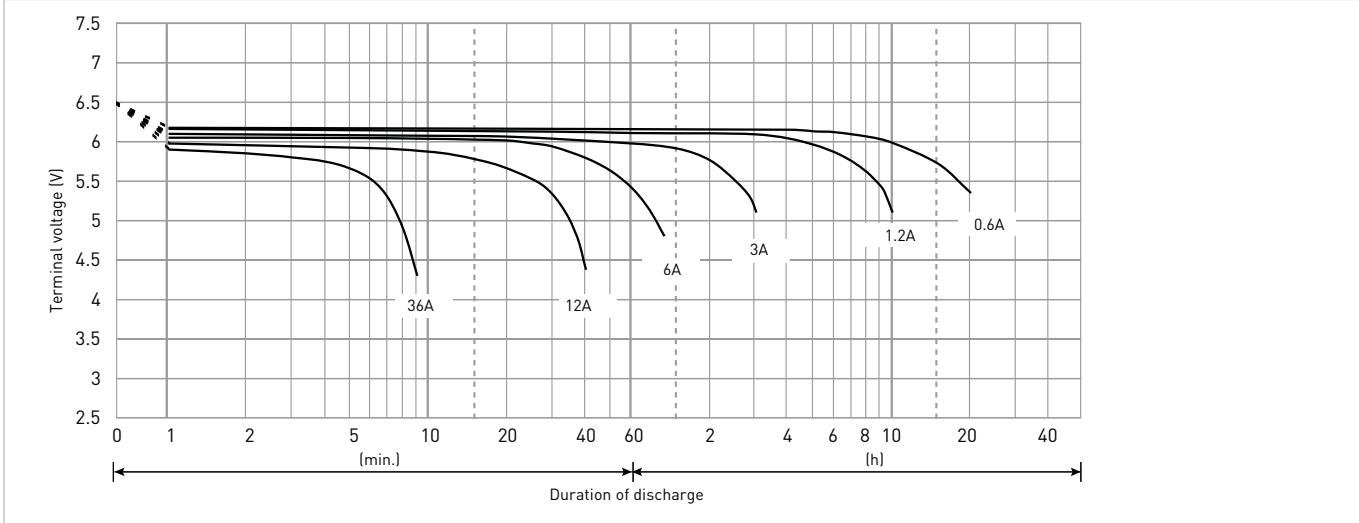

The data in this document are for descriptive purposes only and are not intended to make or imply any guarantee or warranty. Regarding handling and safety please consult our VRLA technical handbook chapter 1.

LC-P06200TA

DIMENSIONS (MM)



FOR STANDBY POWER SUPPLIES.
 EXPECTED TRICKLE DESIGN LIFE: 10 - 12 YEARS AT 20°C
 ACCORDING TO EUROBAT.

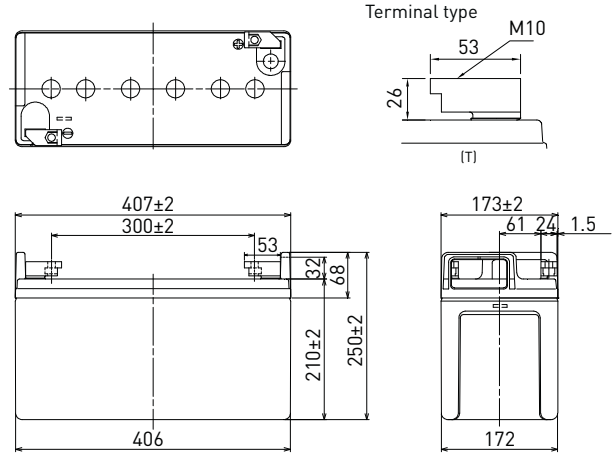

Contents indicated (including the recycle marking, etc.) are subject to change without notice.

Battery case resin: flame retardant (UL94 V-0)

SPECIFICATIONS		
Name	LC-P06200TA	
Nominal voltage	6V	
Nominal capacity (20 hour rate)	200Ah	
Dimensions	Length	407mm
	Width	173mm
	Height	250mm
Approx. mass	33.5kg	
Terminal	M10 T-shape	
Capacity (25°C)	20 hour rate	200Ah
	10 hour rate	195Ah
	3 hour rate	166Ah
	1 hour rate	120Ah
Impedance	Fully charged battery (25°C)	2mΩ
Temperature dependency of capacity (20 hour rate)	40°C	102%
	25°C	100%
	0°C	85%
	-15°C	65%
Remaining capacity (25°C)	After 3 month	91%
	After 6 month	82%
	After 12 month	64%

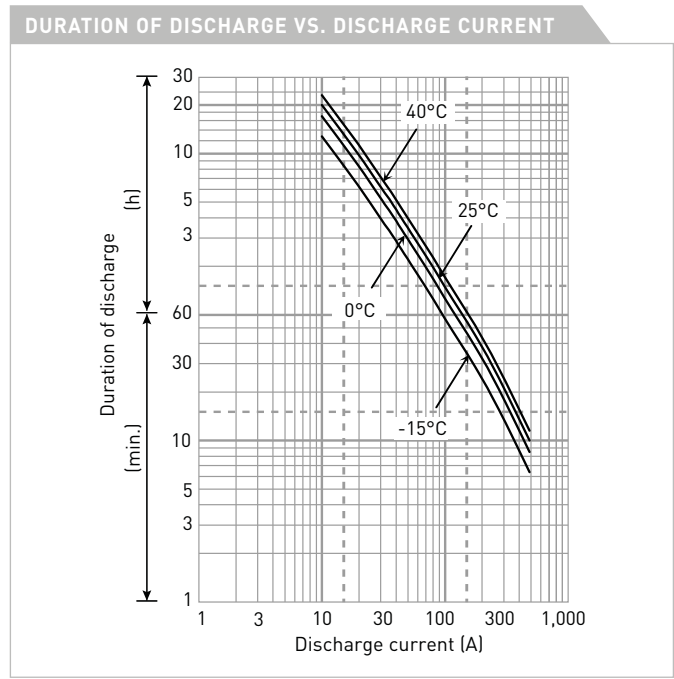

WATT TABLE (25°C)															[Wattage/battery]	
Cut-off	5min.	10min.	15min.	20min.	30min.	45min.	1h	1.5h	2h	3h	4h	5h	6h	10h	20h	
4.80V	2,786	2,306	1,892	1,592	1,206	892	721	525	434	296	225	183	154	93.2	47.0	
4.95V	2,737	2,254	1,847	1,554	1,177	885	702	511	423	291	220	178	149	90.0	46.7	
5.10V	2,565	2,204	1,781	1,498	1,139	877	683	497	417	286	215	173	145	88.9	46.1	
5.25V	2,298	2,134	1,759	1,487	1,130	852	664	483	408	281	213	170	143	87.9	45.8	
5.40V	2,031	1,947	1,676	1,479	1,094	840	655	476	399	275	208	167	140	86.8	45.5	

AMPERE TABLE (25°C)															[Ampere/battery]	
Cut-off	5min.	10min.	15min.	20min.	30min.	45min.	1h	1.5h	2h	3h	4h	5h	6h	10h	20h	
4.80V	591	485	384	318	241	179	135	99.0	81.8	57.9	44.9	37.8	31.2	19.8	10.3	
4.95V	530	480	382	316	239	174	130	97.1	81.2	56.8	44.5	37.2	31.1	19.7	10.2	
5.10V	468	467	380	312	235	173	125	96.3	80.2	56.4	44.1	36.6	31.0	19.6	10.1	
5.25V	408	433	359	298	231	172	120	95.2	79.2	55.2	43.6	36.4	30.5	19.5	10.0	
5.40V	357	379	348	290	228	148	115	85.7	75.2	53.9	43.0	36.2	30.0	19.4	9.80	

All mentioned values are average values

LC-P06200TA

CHARGING METHOD (25°C)

Trickle use Control voltage: 6.80V - 6.90V
Initial current: 30.0A or smaller

CUT-OFF VOLTAGE

Discharge current	10.0A - 40.0A	40.0A - 100A	100A - 200A	200A - 400A	400A - 600A
Cut-off voltage	5.25V	5.10V	4.95V	4.65V	4.35V

INFLUENCE OF TEMPERATURE ON TRICKLE LIFE

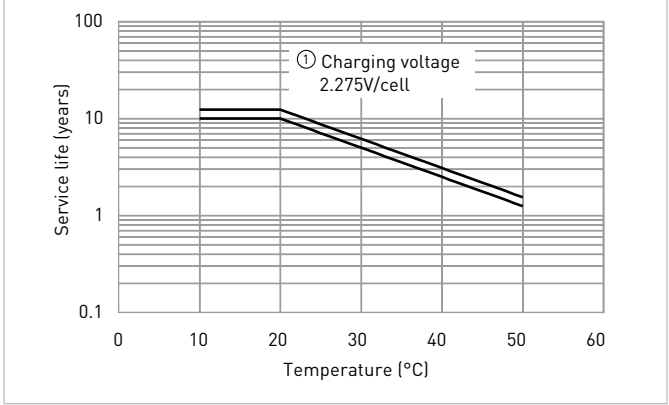

RESIDUAL CAPACITY TEST RESULT

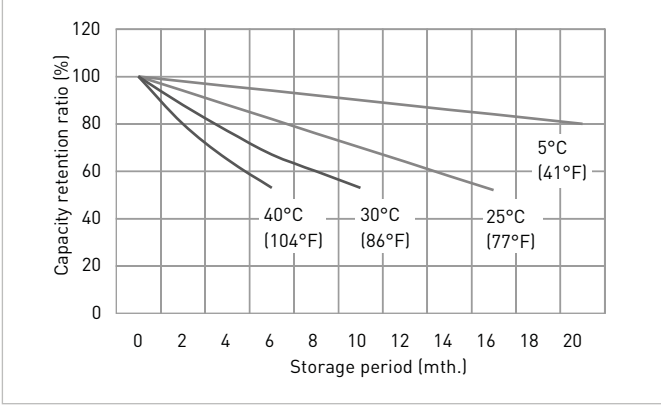

CONSTANT-VOLTAGE CONSTANT-CURRENT CHARGE CHARACTERISTICS FOR TRICKLE USE

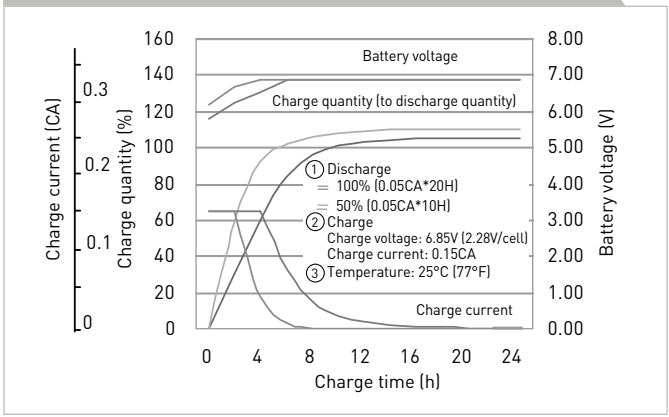

DISCHARGE CAPACITY BY TEMPERATURE AND BY DISCHARGE CURRENT

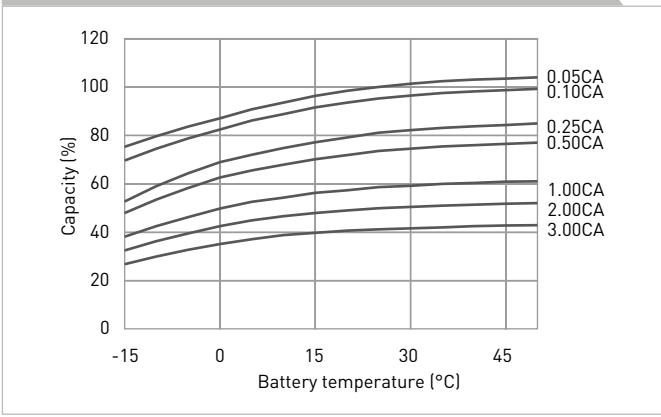

DISCHARGE CHARACTERISTICS

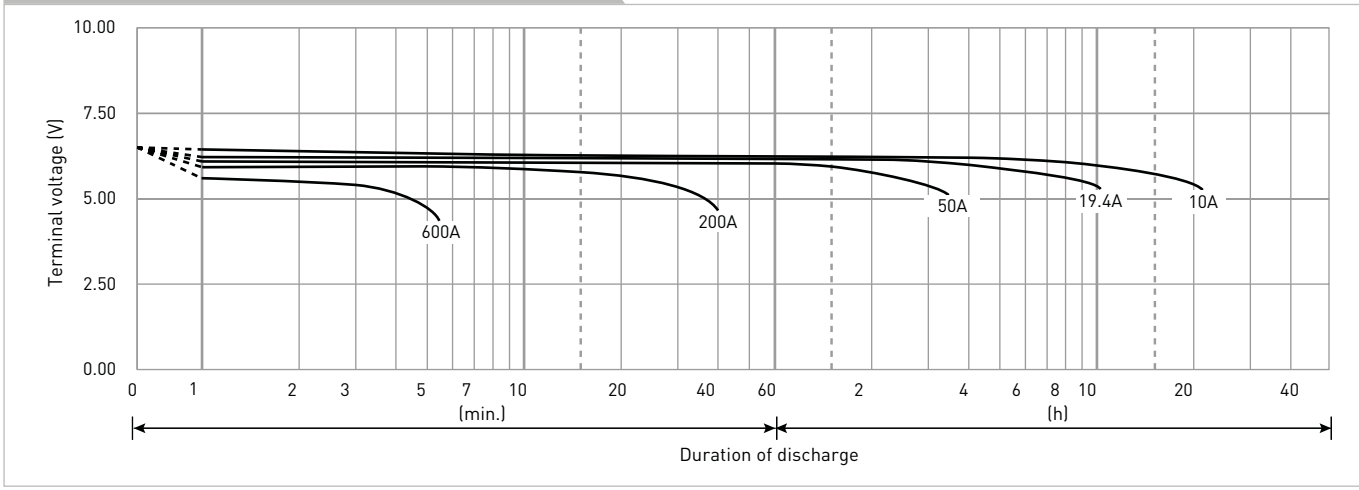

The data in this document are for descriptive purposes only and are not intended to make or imply any guarantee or warranty. Regarding handling and safety please consult our VRLA technical handbook chapter 1.

LC-P067R2P

DIMENSIONS (MM)



Contents indicated (including the recycle marking, etc.) are subject to change without notice.

FOR STANDBY POWER SUPPLIES.
EXPECTED TRICKLE DESIGN LIFE: 10 - 12 YEARS AT 20°C
ACCORDING TO EUROBAT.

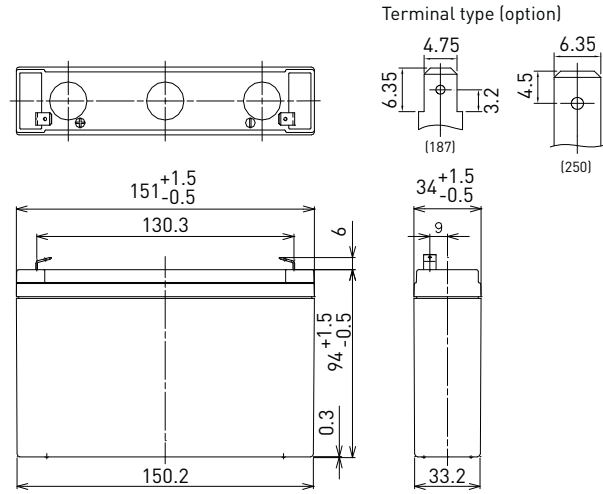

Battery case resin: flame retardant (UL94 V-0)

SPECIFICATIONS		
Name	LC-P067R2P/P1	
Nominal voltage	6V	
Nominal capacity (20 hour rate)	7.2Ah	
Dimensions	Length	151mm
	Width	34mm
	Height	100mm
Approx. mass	1.20kg	
Terminal	Faston 187/250	
Capacity (25°C)	20 hour rate	7.2Ah
	10 hour rate	6.6Ah
	3 hour rate	5.8Ah
	1 hour rate	4.9Ah
Impedance	Fully charged battery (25°C)	15mΩ
Temperature dependency of capacity (20 hour rate)	40°C	102%
	25°C	100%
	0°C	85%
	-15°C	65%
Remaining capacity (25°C)	After 3 month	91%
	After 6 month	82%
	After 12 month	64%

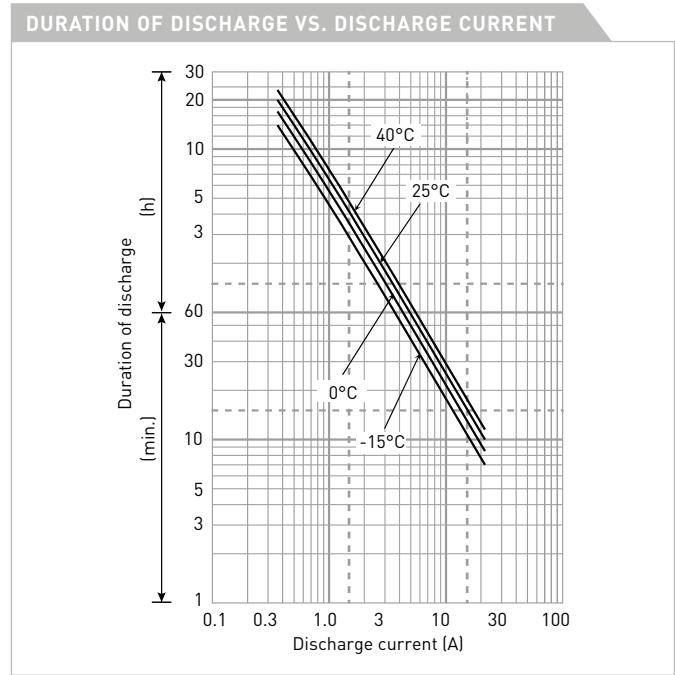

WATT TABLE (25°C)																(Wattage/battery)
Cut-off	3min.	5min.	10min.	15min.	20min.	30min.	45min.	1h	1.5h	2h	3h	4h	5h	6h	10h	20h
4.8V	215	167	110	83.5	67.1	49.2	36.0	28.2	22.3	17.3	12.3	9.60	7.69	6.40	4.19	2.30
4.95V	202	143	93.5	79.5	64.8	48.2	35.8	27.6	21.9	17.2	12.1	9.53	7.63	6.27	4.18	2.29
5.1V	189	136	91.0	75.5	63.0	47.2	34.3	26.8	20.7	16.3	11.8	9.33	7.32	6.11	4.00	2.21
5.25V	172	124	86.8	72.2	60.2	45.4	33.4	26.2	19.9	15.8	11.5	9.15	7.27	6.05	3.98	2.14
5.4V	154	112	82.0	69.1	57.7	43.6	31.3	24.2	18.6	14.0	10.7	8.46	6.67	5.60	3.71	2.07

AMPERE TABLE (25°C)																(Ampere/battery)
Cut-off	3min.	5min.	10min.	15min.	20min.	30min.	45min.	1h	1.5h	2h	3h	4h	5h	6h	10h	20h
4.8V	38.9	30.6	19.9	14.8	12.3	9.10	6.40	5.10	3.50	2.70	2.00	1.53	1.26	1.02	0.670	0.363
4.95V	36.1	28.7	19.5	14.7	12.1	9.00	6.36	5.05	3.43	2.68	1.99	1.52	1.25	1.01	0.667	0.362
5.1V	34.2	26.9	19.0	14.4	11.9	8.90	6.30	5.00	3.36	2.61	1.97	1.51	1.24	1.00	0.660	0.361
5.25V	31.4	24.1	17.6	13.4	11.3	8.70	6.20	4.90	3.29	2.52	1.94	1.50	1.23	0.988	0.657	0.360
5.4V	29.0	22.3	15.7	12.5	11.0	8.40	6.10	4.80	3.20	2.40	1.90	1.48	1.20	0.972	0.650	0.358

All mentioned values are average values

LC-P067R2P

CHARGING METHOD (25°C)

Trickle use Control voltage 6.8V - 6.9V
Initial current 1.08A or smaller

CUT-OFF VOLTAGE

Discharge current	0.36A - 1.44A	1.44A - 3.6A	3.6A - 7.2A	7.2A - 14.4A	14.4A - 21.6A
Cut-off voltage	5.25V	5.10V	4.95V	4.65V	4.35V

INFLUENCE OF TEMPERATURE ON TRICKLE LIFE

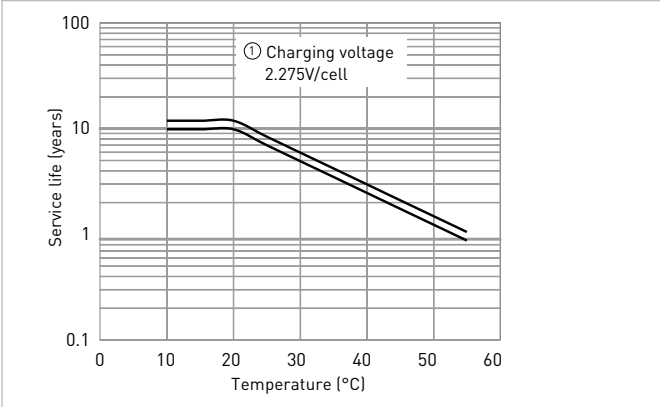

RESIDUAL CAPACITY VS. STORAGE PERIOD

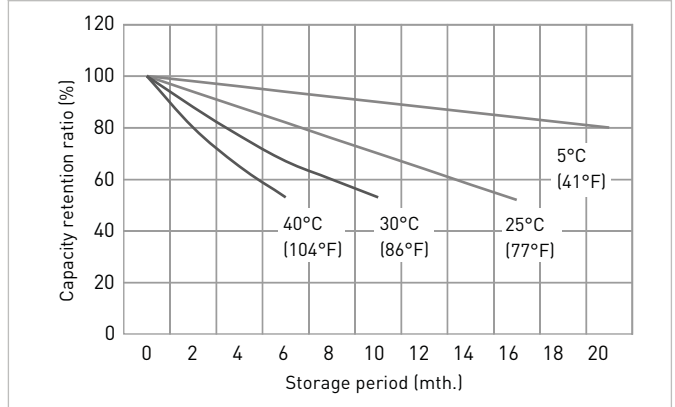

CONSTANT-VOLTAGE CONSTANT-CURRENT CHARGE CHARACTERISTICS FOR TRICKLE USE

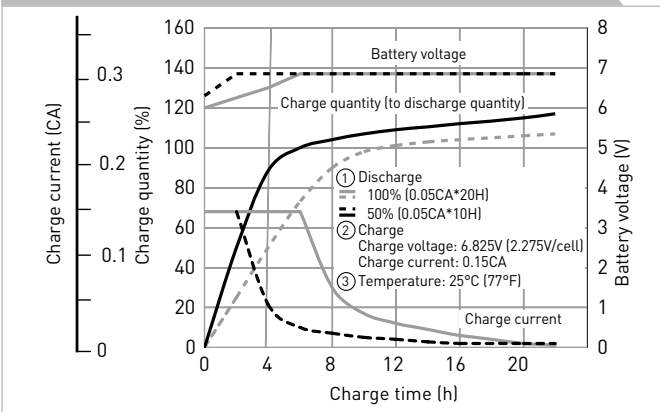

DISCHARGE CAPACITY BY TEMPERATURE AND BY DISCHARGE CURRENT

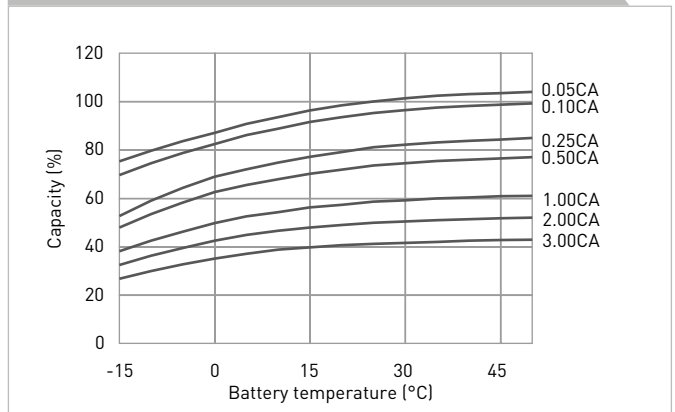

DISCHARGE CHARACTERISTICS

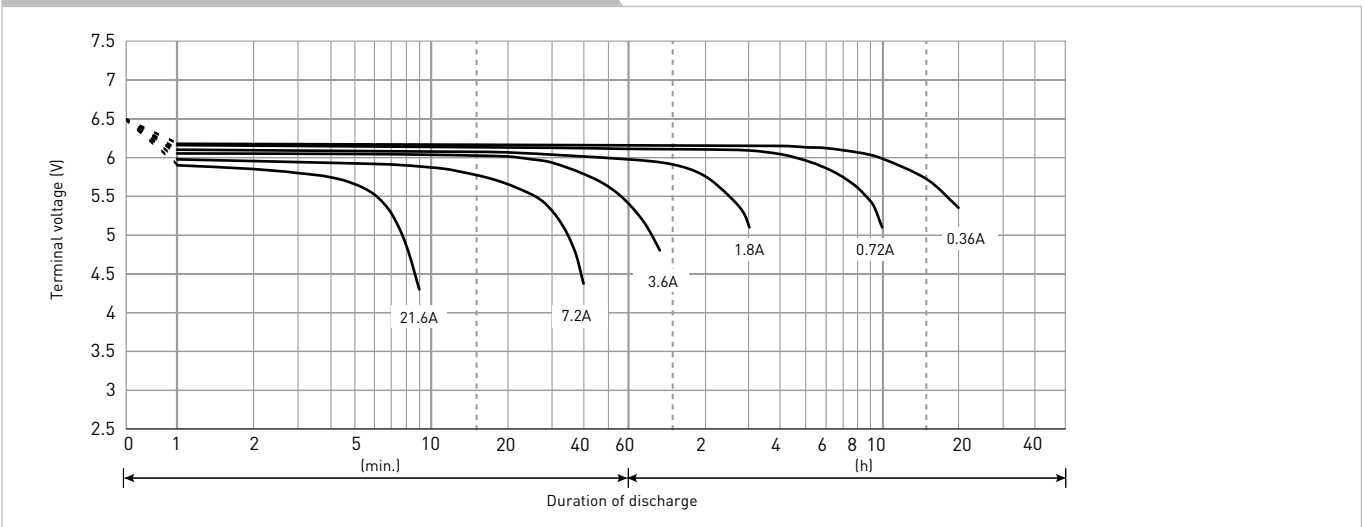

The data in this document are for descriptive purposes only and are not intended to make or imply any guarantee or warranty. Regarding handling and safety please consult our VRLA technical handbook chapter 1.

LC-P12120P

DIMENSIONS (MM)



Contents indicated (including the recycle marking, etc.) are subject to change without notice.

FOR STANDBY POWER SUPPLIES.
EXPECTED TRICKLE DESIGN LIFE: 10 - 12 YEARS AT 20°C
ACCORDING TO EUROBAT.

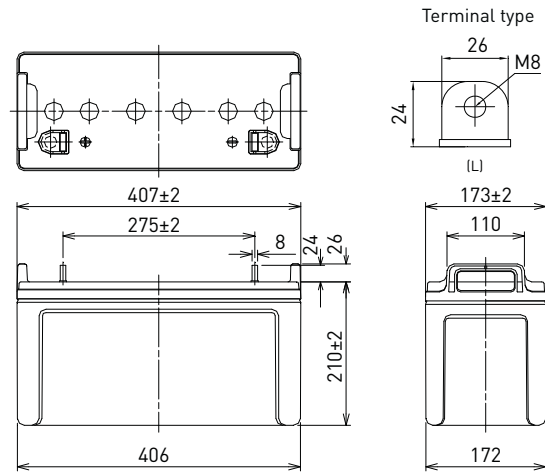

Battery case resin: flame retardant (UL94 V-0)

SPECIFICATIONS		LC-P12120P
Name		LC-P12120P
Nominal voltage		12V
Nominal capacity (20 hour rate)		120Ah
Dimensions	Length	407mm
	Width	173mm
	Height	236mm
Approx. mass		34.5kg
Terminal		M8 bolt/nut
Capacity (25°C)	20 hour rate	120Ah
	10 hour rate	110Ah
	3 hour rate	93Ah
	1 hour rate	85Ah
Impedance		Fully charged battery (25°C) 4.5mΩ
Temperature dependency of capacity (20 hour rate)	40°C	102%
	25°C	100%
	0°C	85%
	-15°C	65%
Remaining capacity (25°C)	After 3 month	91%
	After 6 month	82%
	After 12 month	64%

DURATION OF DISCHARGE VS. DISCHARGE CURRENT

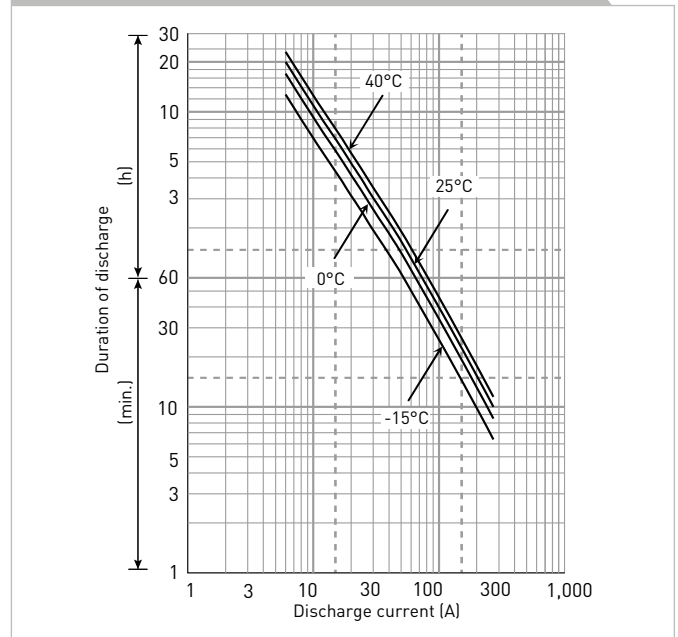

WATT TABLE (25°C)															[Wattage/battery]	
Cut-off	5min.	10min.	15min.	20min.	30min.	45min.	1h	1.5h	2h	3h	4h	5h	6h	10h	20h	
9.6V	3,603	2,883	2,296	2,036	1,409	1,095	835	663	499	326	261	197	179	104	60.2	
9.9V	3,537	2,849	2,285	2,024	1,370	1,062	820	662	486	322	255	191	177	103	60.1	
10.2V	3,309	2,776	2,273	2,001	1,322	1,040	805	642	479	315	249	185	168	102	60.0	
10.5V	3,020	2,572	2,148	1,907	1,316	1,025	779	629	470	310	246	184	166	101	60.0	
10.8V	2,916	2,294	2,079	1,861	1,281	980	756	559	458	306	240	180	163	99.8	59.9	

AMPERE TABLE (25°C)															[Ampere/battery]	
Cut-off	5min.	10min.	15min.	20min.	30min.	45min.	1h	1.5h	2h	3h	4h	5h	6h	10h	20h	
9.6V	361	271	211	181	139	105	86.9	59.3	47.9	32.1	23.7	20.6	17.4	11.1	6.00	
9.9V	357	267	210	180	138	102	86.6	58.1	47.5	31.5	23.4	20.4	17.3	11.1	6.00	
10.2V	348	261	209	178	136	97.0	85.9	57.7	46.9	31.2	23.2	20.0	17.2	11.0	6.00	
10.5V	322	241	198	170	134	92.0	85.4	56.9	46.3	31.0	23.0	19.9	17.1	11.0	6.00	
10.8V	282	211	192	165	132	86.9	74.0	51.2	44.0	29.9	22.7	19.8	16.7	10.9	5.88	

All mentioned values are average values

LC-P12120P

CHARGING METHOD (25°C)

Trickle use Control voltage: 13.6V - 13.8V
Initial current: 18.0A or smaller

CUT-OFF VOLTAGE

Discharge current	6.00A - 24.0A	24.0A - 60.0A	60.0A - 120A	120A - 240A	240A - 300A
Cut-off voltage	10.5V	10.2V	9.9V	9.3V	8.7V

INFLUENCE OF TEMPERATURE ON TRICKLE LIFE

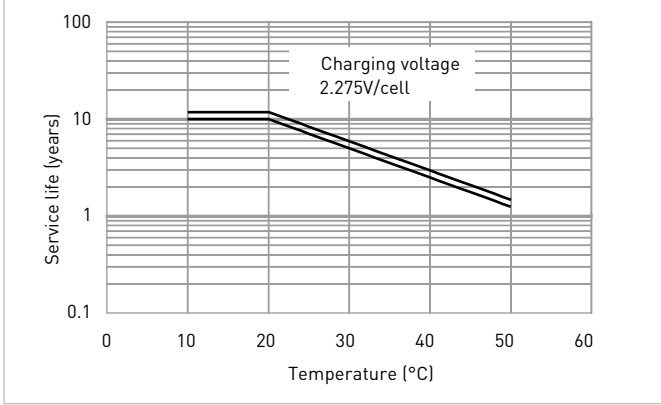

RESIDUAL CAPACITY TEST RESULT

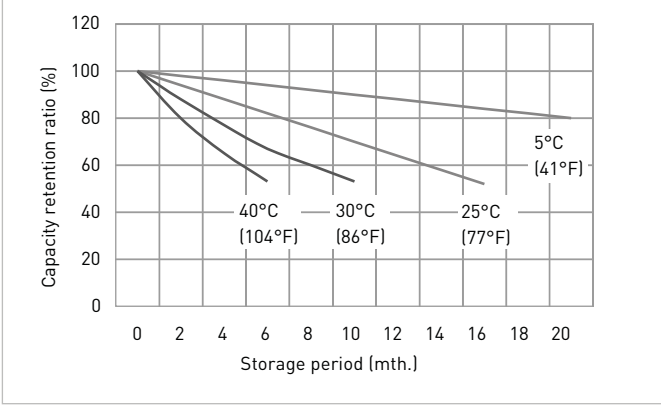

CONSTANT-VOLTAGE CONSTANT-CURRENT CHARGE CHARACTERISTICS FOR TRICKLE USE

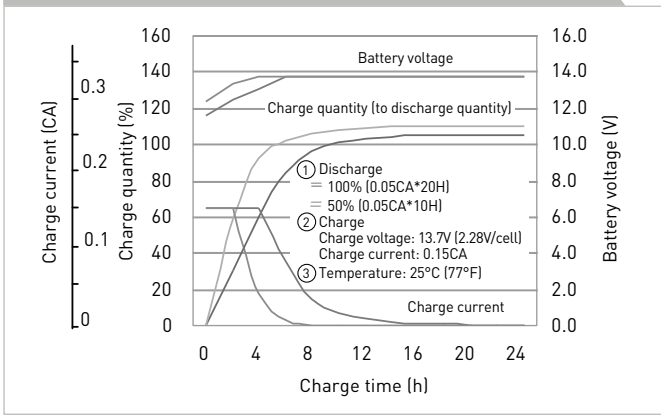

DISCHARGE CAPACITY BY TEMPERATURE AND BY DISCHARGE CURRENT

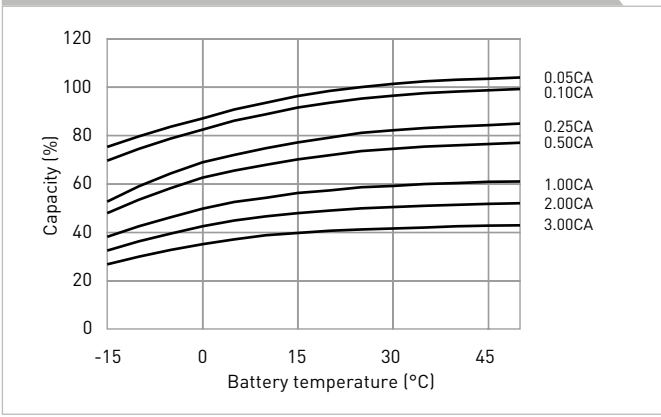

DISCHARGE CHARACTERISTICS

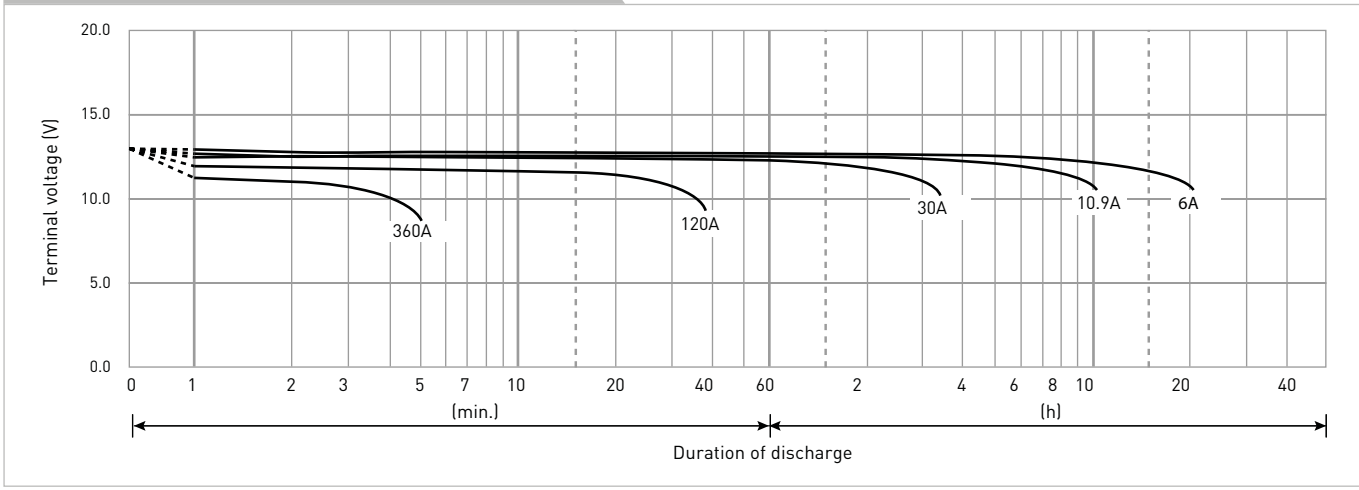

The data in this document are for descriptive purposes only and are not intended to make or imply any guarantee or warranty. Regarding handling and safety please consult our VRLA technical handbook chapter 1.

LC-P12150BP*1

DIMENSIONS (MM)



Contents indicated (including the recycle marking, etc.) are subject to change without notice.

FOR STANDBY POWER SUPPLIES.
EXPECTED TRICKLE DESIGN LIFE: 10 - 12 YEARS AT 20°C
ACCORDING TO EUROBAT.

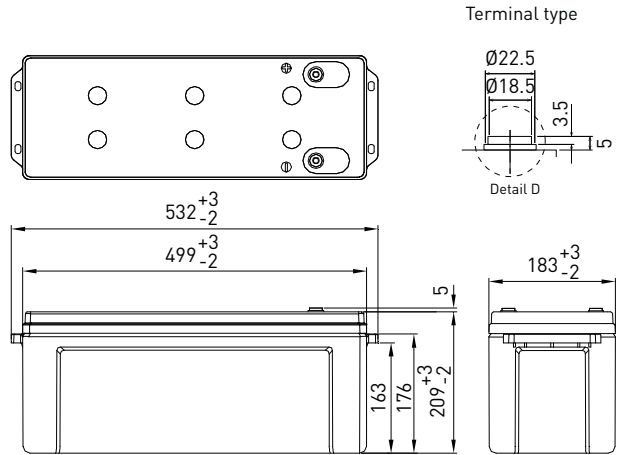

Battery case resin: flame retardant (UL94 V-0)

SPECIFICATIONS		
Name	LC-P12150BP*1	
Nominal voltage	12V	
Nominal capacity (20 hour rate)	150Ah	
Dimensions	Length	532mm
	Width	183mm
	Height	214mm
Approx. mass	43.0kg	
Terminal	M8 insert	
Capacity (25°C)	20 hour rate	150Ah
	10 hour rate	137Ah
	3 hour rate	119Ah
	1 hour rate	88Ah
Impedance	Fully charged battery (25°C)	3.5mΩ
	40°C	102%
Temperature dependency of capacity (20 hour rate)	25°C	100%
	0°C	85%
	-15°C	65%
Remaining capacity (25°C)	After 3 month	91%
	After 6 month	82%
	After 12 month	64%

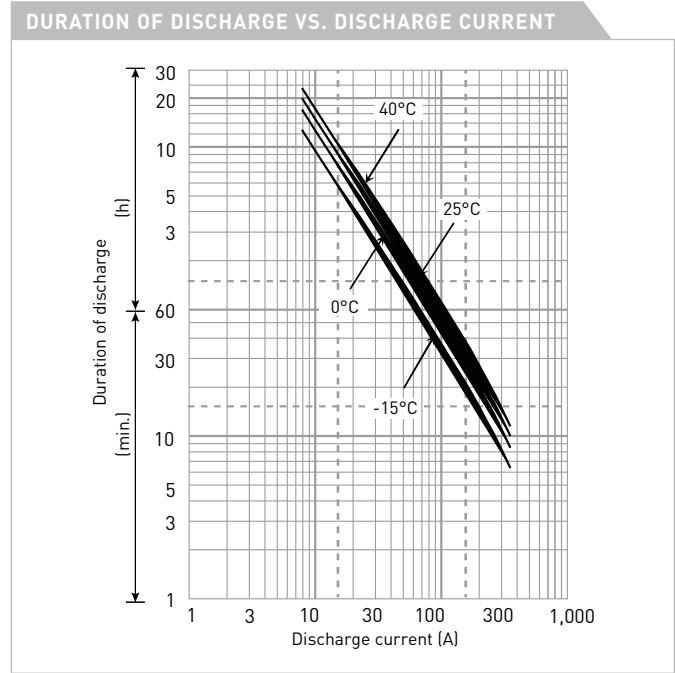

WATT TABLE (25°C)															[Wattage/battery]	
Cut-off	5min.	10min.	15min.	20min.	30min.	45min.	1h	1.5h	2h	3h	4h	5h	6h	10h	20h	
9.6V	5,040	3,780	3,000	2,390	1,774	1,310	1,046	791	608	444	348	284	242	164	91.2	
9.9V	4,925	3,689	2,923	2,334	1,727	1,276	1,013	763	596	437	342	281	240	163	91.2	
10.2V	4,340	3,405	2,833	2,261	1,672	1,238	976	724	592	433	339	278	237	163	91.1	
10.5V	4,020	3,216	2,751	2,197	1,641	1,208	947	695	585	428	334	274	235	161	90.3	
10.8V	3,850	2,839	2,661	2,149	1,601	1,163	910	659	576	420	328	268	232	160	90.3	

AMPERE TABLE (25°C)															[Ampere/battery]	
Cut-off	5min.	10min.	15min.	20min.	30min.	45min.	1h	1.5h	2h	3h	4h	5h	6h	10h	20h	
9.6V	490	350	266	217	164	120	97.2	70.0	59.0	42.1	32.9	27.3	23.0	14.0	7.58	
9.9V	479	342	259	212	159	117	94.1	67.5	58.0	41.3	32.3	26.7	22.6	13.9	7.58	
10.2V	422	315	251	206	154	114	90.7	64.1	56.9	40.4	31.5	26.0	22.2	13.8	7.50	
10.5V	381	298	244	200	151	111	88.0	61.5	55.8	39.8	31.0	25.7	22.0	13.7	7.50	
10.8V	334	263	236	195	148	107	84.6	58.3	54.4	38.8	30.3	25.2	21.6	13.5	7.49	

All mentioned values are average values

LC-P12150BP*1

CHARGING METHOD (25°C)

Trickle use Control voltage: 13.6V - 13.8V
Initial current: 22.5A or smaller

CUT-OFF VOLTAGE

Discharge current	7.50A - 30.0A	30.0A - 75.0A	75.0A - 150A	150A - 300A	300A - 450A
Cut-off voltage	10.5V	10.2V	9.9V	9.3V	8.7V

INFLUENCE OF TEMPERATURE ON TRICKLE LIFE

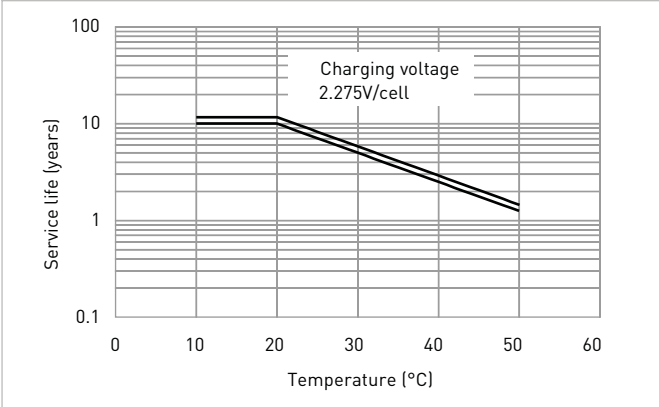

RESIDUAL CAPACITY TEST RESULT

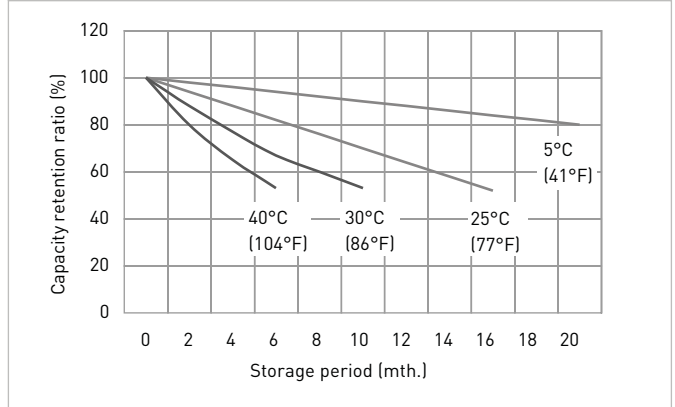

CONSTANT-VOLTAGE CONSTANT-CURRENT CHARGE CHARACTERISTICS FOR TRICKLE USE

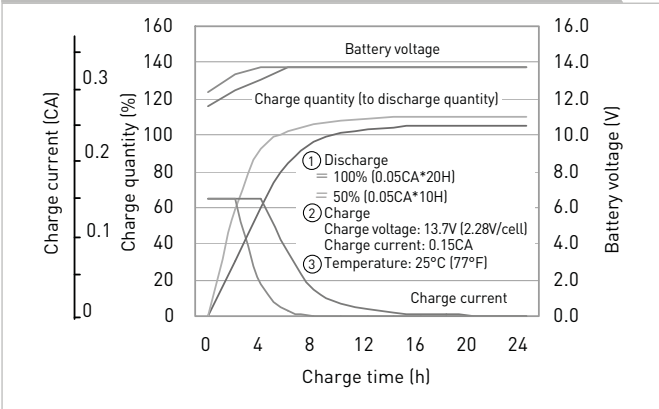

DISCHARGE CAPACITY BY TEMPERATURE AND BY DISCHARGE CURRENT

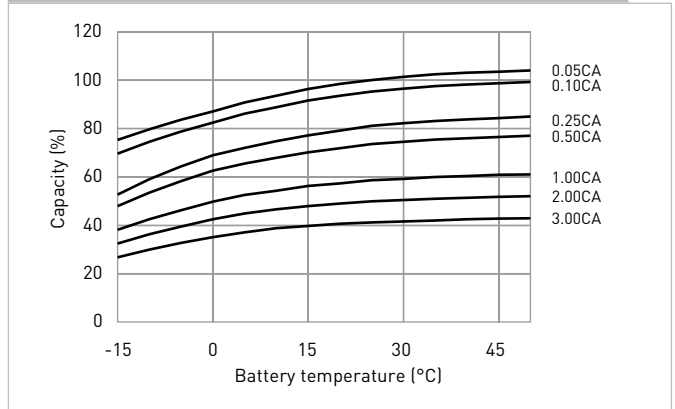

DISCHARGE CHARACTERISTICS

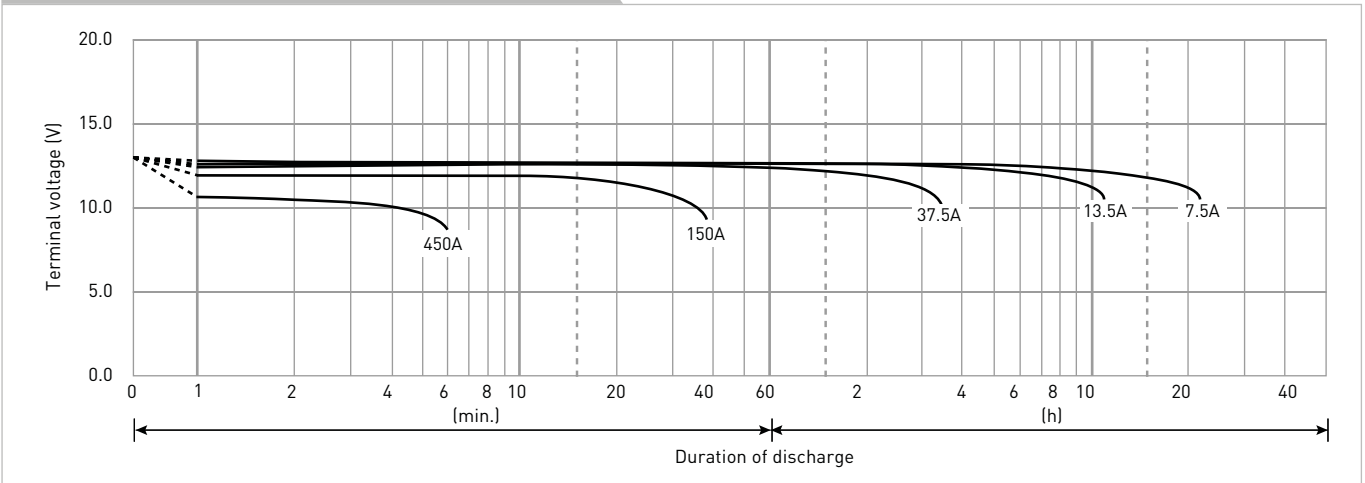

The data in this document are for descriptive purposes only and are not intended to make or imply any guarantee or warranty. Regarding handling and safety please consult our VRLA technical handbook chapter 1.

*1 This battery is equipped with insert terminals.

LC-P12200BP*1

DIMENSIONS (MM)



FOR STANDBY POWER SUPPLIES.
EXPECTED TRICKLE DESIGN LIFE: 10 - 12 YEARS AT 20°C
ACCORDING TO EUROBAT.

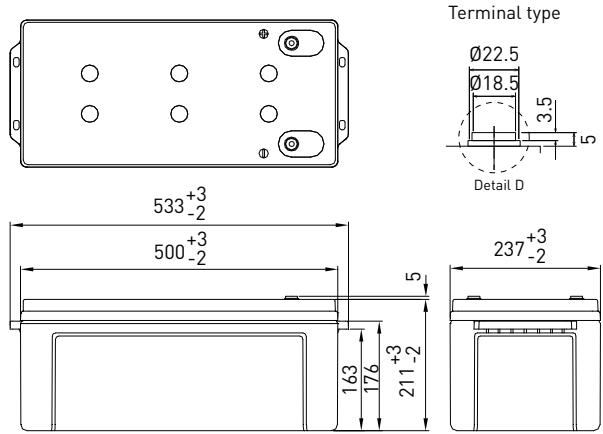

Contents indicated (including the recycle marking, etc.) are subject to change without notice.

Battery case resin: flame retardant (UL94 V-0)

SPECIFICATIONS		
Name	LC-P12200BP*1	
Nominal voltage	12V	
Nominal capacity (20 hour rate)	200Ah	
Dimensions	Length	533mm
	Width	237mm
	Height	216mm
Approx. mass	57.0kg	
Terminal	M8 insert	
Capacity (25°C)	20 hour rate	200Ah
	10 hour rate	187Ah
	3 hour rate	169Ah
	1 hour rate	118Ah
Impedance	Fully charged battery (25°C)	2.5mΩ
	40°C	102%
Temperature dependency of capacity (20 hour rate)	25°C	100%
	0°C	85%
	-15°C	65%
Remaining capacity (25°C)	After 3 month	91%
	After 6 month	82%
	After 12 month	64%

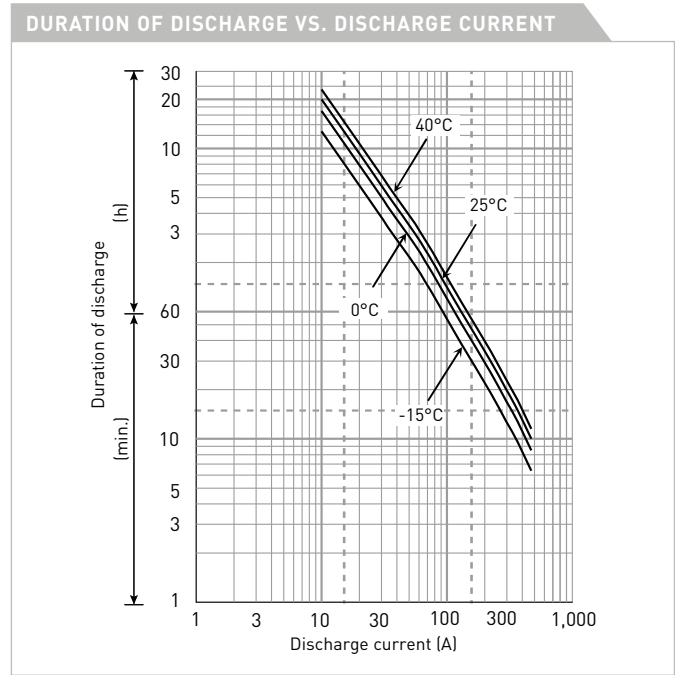

WATT TABLE (25°C)															[Wattage/battery]	
Cut-off	5min.	10min.	15min.	20min.	30min.	45min.	1h	1.5h	2h	3h	4h	5h	6h	10h	20h	
9.6V	6,577	5,182	4,285	3,512	2,651	1,863	1,505	1,106	917	668	524	432	369	235	129	
9.9V	6,427	5,052	4,264	3,491	2,577	1,807	1,478	1,105	893	660	512	420	363	234	128	
10.2V	5,643	4,649	3,966	3,175	2,352	1,674	1,336	965	837	618	483	401	333	222	128	
10.5V	5,092	4,390	3,851	3,085	2,308	1,634	1,296	925	821	608	475	396	331	221	128	
10.8V	4,462	3,876	3,725	3,017	2,253	1,573	1,246	877	800	592	464	388	325	220	128	

AMPERE TABLE (25°C)															[Ampere/battery]	
Cut-off	5min.	10min.	15min.	20min.	30min.	45min.	1h	1.5h	2h	3h	4h	5h	6h	10h	20h	
9.6V	655	471	366	297	222	163	130	95.7	86.0	59.6	45.6	37.0	30.2	19.0	10.1	
9.9V	640	460	357	290	217	159	126	92.3	84.6	58.5	44.8	36.1	29.8	18.9	10.1	
10.2V	564	425	346	281	210	154	121	87.7	83.0	57.3	43.7	35.3	29.2	18.8	10.0	
10.5V	509	401	336	273	206	150	118	84.1	81.5	56.4	43.0	34.9	29.0	18.7	10.0	
10.8V	446	354	325	267	201	145	113	79.7	79.4	54.9	42.0	34.1	28.4	18.5	9.99	

All mentioned values are average values

LC-P12200BP*1

CHARGING METHOD (25°C)

Trickle use Control voltage: 13.6V - 13.8V
Initial current: 30.0A or smaller

CUT-OFF VOLTAGE

Discharge current	10.0A - 40.0A	40.0A - 100A	100A - 200A	200A - 400A	400A - 600A
Cut-off voltage	10.5V	10.2V	9.9V	9.3V	8.7V

INFLUENCE OF TEMPERATURE ON TRICKLE LIFE

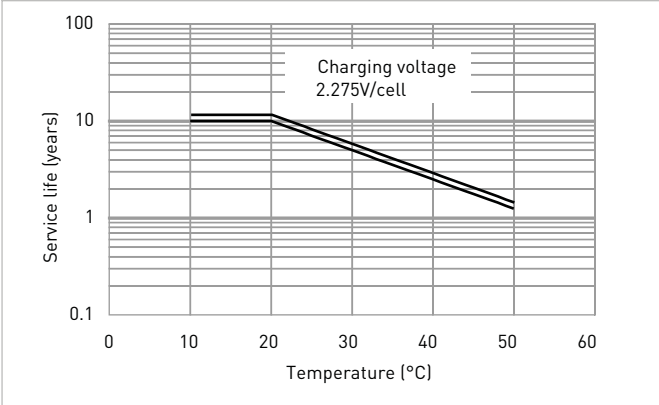

RESIDUAL CAPACITY TEST RESULT

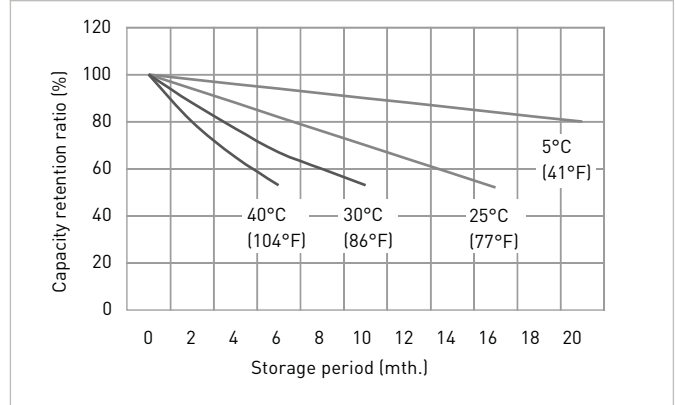

CONSTANT-VOLTAGE CONSTANT-CURRENT CHARGE CHARACTERISTICS FOR TRICKLE USE

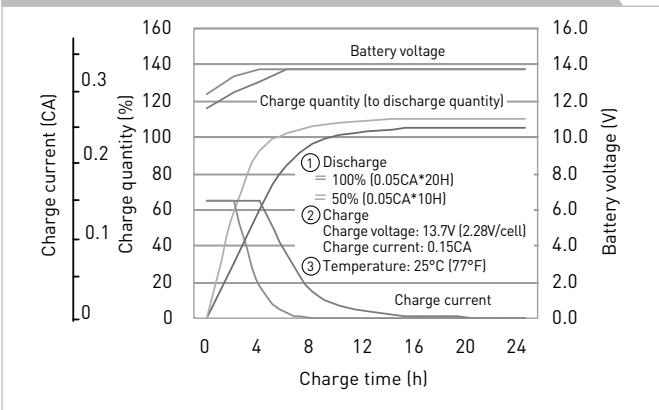

DISCHARGE CAPACITY BY TEMPERATURE AND BY DISCHARGE CURRENT

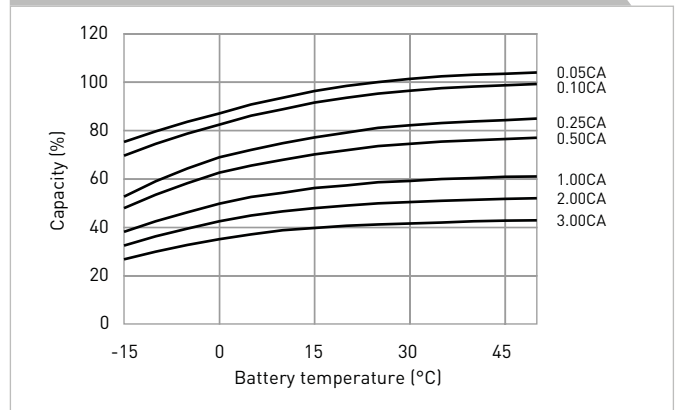

DISCHARGE CHARACTERISTICS

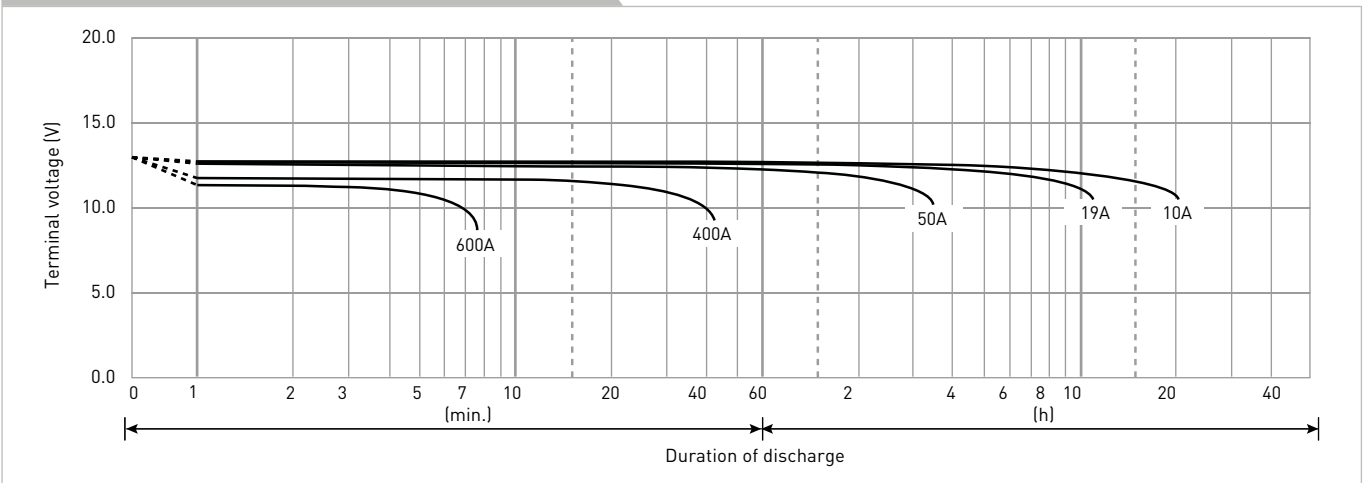

The data in this document are for descriptive purposes only and are not intended to make or imply any guarantee or warranty. Regarding handling and safety please consult our VRLA technical handbook chapter 1.

*1 This battery is equipped with insert terminals.

LC-P1220P

DIMENSIONS (MM)



Contents indicated (including the recycle marking, etc.) are subject to change without notice.

FOR STANDBY POWER SUPPLIES.
EXPECTED TRICKLE DESIGN LIFE: 10 – 12 YEARS AT 20°C
ACCORDING TO EUROBAT.

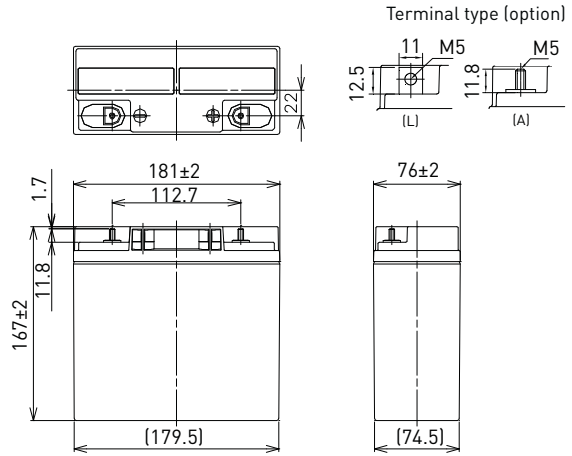

Battery case resin: flame retardant (UL94 V-0)

SPECIFICATIONS		
Name	LC-P1220P/AP	
Nominal voltage	12V	
Nominal capacity (20 hour rate)	20Ah	
Dimensions	Length	181mm
	Width	76mm
	Height	167mm
Approx. mass	5.80kg	
Terminal	M5 bolt/nut & threaded post	
Capacity (25°C)	20 hour rate	20Ah
	10 hour rate	17Ah
	3 hour rate	15Ah
	1 hour rate	12Ah
Impedance	Fully charged battery (25°C)	15mΩ
	40°C	102%
Temperature dependency of capacity (20 hour rate)	25°C	100%
	0°C	85%
	-15°C	65%
Remaining capacity (25°C)	After 3 month	91%
	After 6 month	82%
	After 12 month	64%

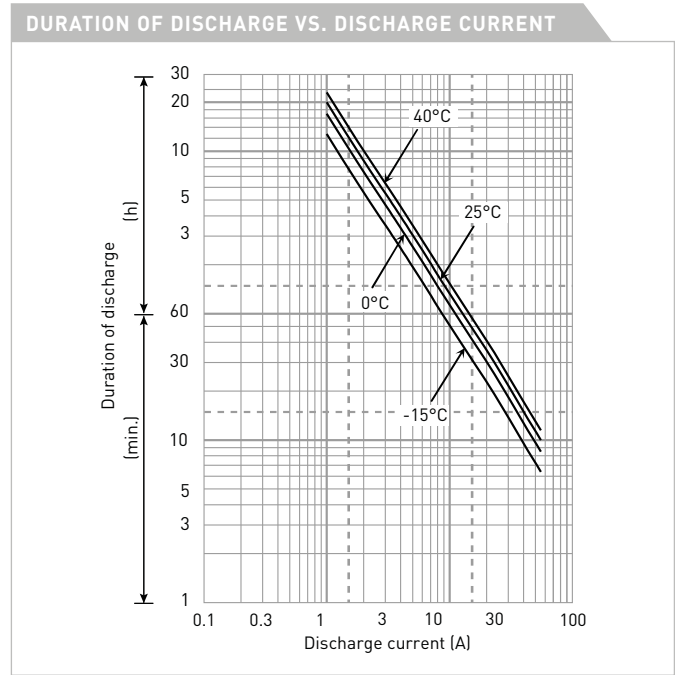

WATT TABLE (25°C)														[Wattage/battery]	
Cut-off	5min.	10min.	15min.	20min.	30min.	45min.	1h	1.5h	2h	3h	4h	5h	6h	10h	20h
9.6V	853	557	425	357	266	188	150	103	83.1	61.9	47.5	39.2	31.5	21.6	11.7
9.9V	800	546	423	351	263	186	148	101	82.5	61.5	47.2	38.9	31.4	21.5	11.7
10.2V	750	532	414	345	260	185	146	99.1	80.3	60.9	46.9	38.6	31.2	21.3	11.6
10.5V	672	493	385	328	254	182	145	97.0	77.5	60.0	46.6	38.3	30.8	21.2	11.6
10.8V	594	440	359	319	246	179	141	94.3	73.9	58.8	46.0	37.4	30.3	21.0	11.5

AMPERE TABLE (25°C)														[Ampere/battery]	
Cut-off	5min.	10min.	15min.	20min.	30min.	45min.	1h	1.5h	2h	3h	4h	5h	6h	10h	20h
9.6V	85.0	55.3	40.0	34.2	24.0	16.9	12.7	9.04	6.98	5.17	3.95	3.26	2.61	1.75	1.01
9.9V	79.7	54.2	39.7	33.6	23.7	16.8	12.6	8.86	6.92	5.14	3.93	3.23	2.60	1.75	1.01
10.2V	74.7	52.8	38.9	33.1	23.5	16.6	12.4	8.68	6.74	5.09	3.90	3.20	2.58	1.73	1.00
10.5V	66.9	48.9	36.2	31.4	22.9	16.4	12.2	8.50	6.51	5.01	3.88	3.18	2.55	1.72	1.00
10.8V	59.2	43.6	33.8	30.6	22.2	16.1	12.0	8.27	6.20	4.91	3.82	3.10	2.51	1.70	0.994

All mentioned values are average values

LC-P1220P

CHARGING METHOD (25°C)

Trickle use	Control voltage: 13.6V - 13.8V Initial current: 3.00A or smaller
--------------------	---

CUT-OFF VOLTAGE

Discharge current	1.00A - 4.00A	4.00A - 10.0A	10.0A - 20.0A	20.0A - 40.0A	40.0A - 60.0A
Cut-off voltage	10.5V	10.2V	9.9V	9.3V	8.7V

INFLUENCE OF TEMPERATURE ON TRICKLE LIFE

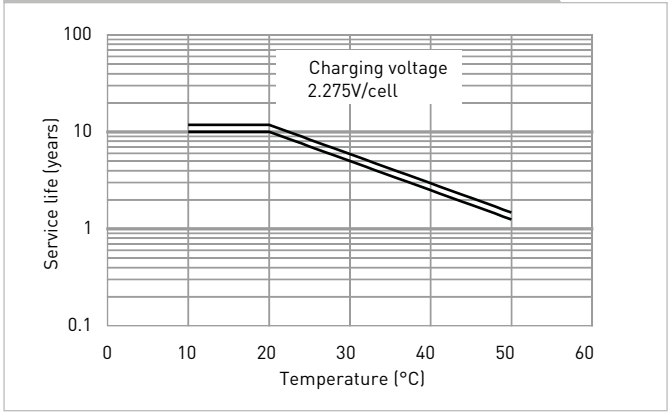

RESIDUAL CAPACITY TEST RESULT

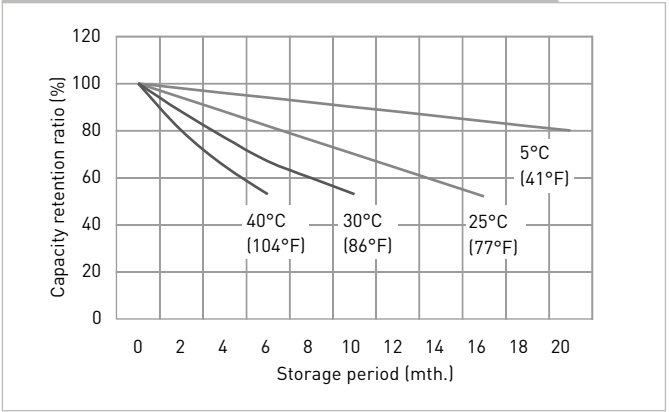

CONSTANT-VOLTAGE CONSTANT-CURRENT CHARGE CHARACTERISTICS FOR TRICKLE USE

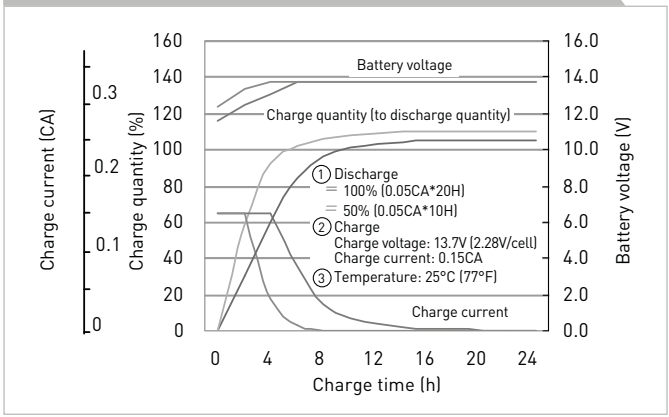

DISCHARGE CAPACITY BY TEMPERATURE AND BY DISCHARGE CURRENT

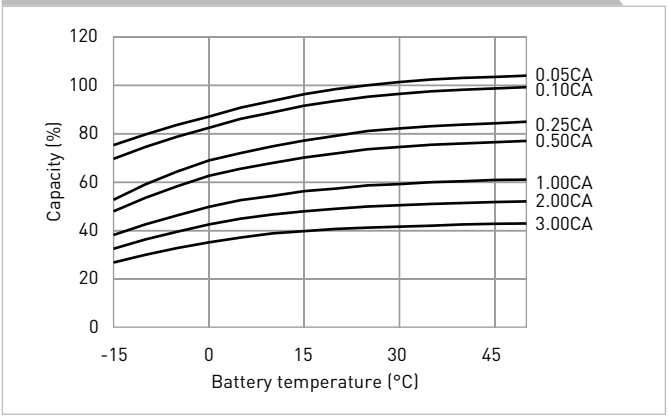

DISCHARGE CHARACTERISTICS

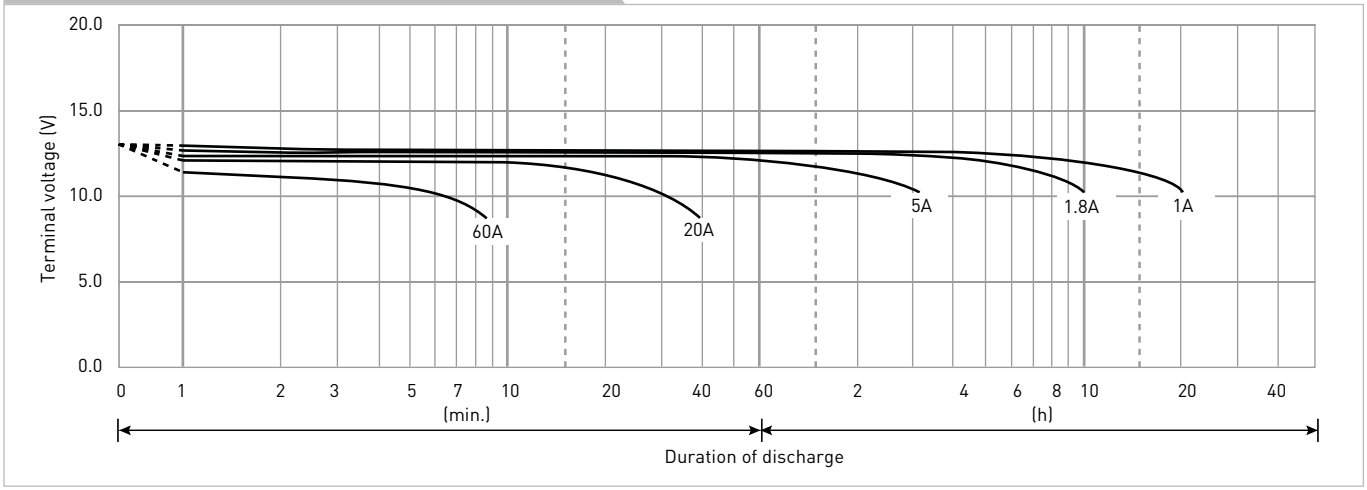

The data in this document are for descriptive purposes only and are not intended to make or imply any guarantee or warranty. Regarding handling and safety please consult our VRLA technical handbook chapter 1.

LC-P1224P

DIMENSIONS (MM)



Contents indicated (including the recycle marking, etc.) are subject to change without notice.

FOR STANDBY POWER SUPPLIES.
EXPECTED TRICKLE DESIGN LIFE: 10 - 12 YEARS
AT 20°C ACCORDING TO EUROBAT.



G198049

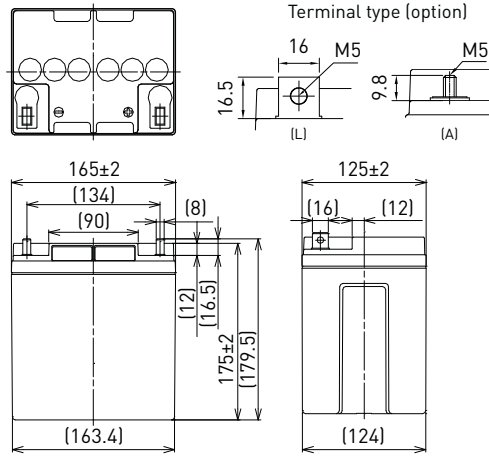

Battery case resin: flame retardant (UL94 V-0)

SPECIFICATIONS		
Name		LC-P1224PG/APG
Nominal voltage		12V
Nominal capacity (20 hour rate)		24Ah
Dimensions	Length	165mm
	Width	125mm
	Height	179.5mm/175mm
Approx. mass		8.05kg
Terminal		M5 bolt/nut & threaded post
Capacity (25°C)	20 hour rate	24Ah
	10 hour rate	22Ah
	3 hour rate	18Ah
	1 hour rate	14Ah
Impedance		Fully charged battery (25°C) 11mΩ
Temperature dependency of capacity (20 hour rate)	40°C	102%
	25°C	100%
	0°C	85%
	-15°C	65%
Remaining capacity (25°C)	After 3 month	91%
	After 6 month	82%
	After 12 month	64%

DURATION OF DISCHARGE VS. DISCHARGE CURRENT

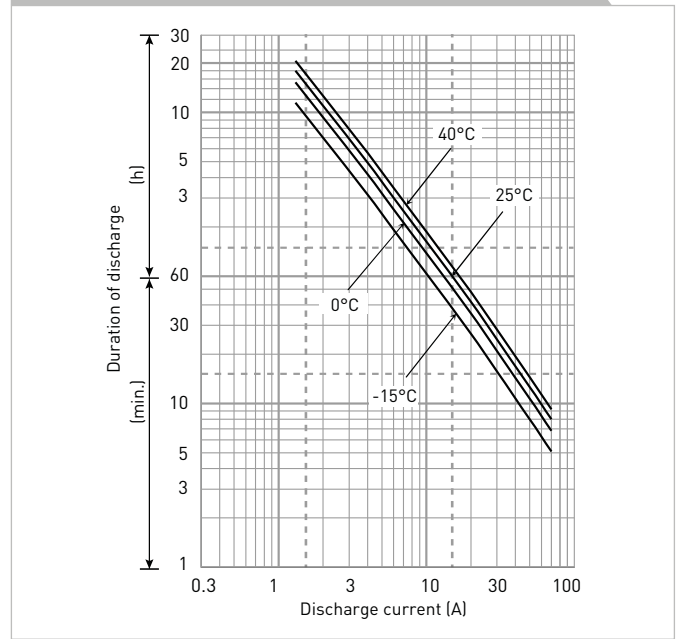

WATT TABLE (25°C)													[Wattage/battery]			
Cut-off	5min.	10min.	15min.	20min.	30min.	45min.	1h	1.5h	2h	3h	4h	5h	6h	10h	20h	
9.6V	992	739	523	441	317	234	183	118	104	73.8	58.6	47.9	40.8	26.4	14.6	
9.9V	931	724	520	434	314	232	181	116	103	73.4	58.2	47.5	40.6	26.3	14.6	
10.2V	872	706	509	426	310	230	179	113	101	72.7	57.8	47.2	40.3	26.0	14.5	
10.5V	782	654	474	405	303	226	175	111	97.2	71.6	57.4	46.8	39.8	25.9	14.4	
10.8V	691	583	442	394	293	223	172	108	92.6	70.1	56.6	45.6	39.2	25.6	14.3	

AMPERE TABLE (25°C)													[Ampere/battery]			
Cut-off	5min.	10min.	15min.	20min.	30min.	45min.	1h	1.5h	2h	3h	4h	5h	6h	10h	20h	
9.6V	89.0	66.0	45.5	38.0	27.1	19.9	14.6	10.0	8.80	6.20	4.90	3.89	3.40	2.27	1.23	
9.9V	83.5	64.7	45.2	37.4	26.8	19.8	14.5	9.80	8.73	6.17	4.87	3.86	3.39	2.26	1.22	
10.2V	78.2	63.0	44.3	36.8	26.5	19.6	14.3	9.60	8.51	6.11	4.84	3.83	3.36	2.23	1.21	
10.5V	70.1	58.4	41.2	34.9	25.9	19.3	14.0	9.40	8.21	6.01	4.80	3.80	3.32	2.22	1.20	
10.8V	62.0	52.1	38.4	34.0	25.0	19.0	13.7	9.14	7.82	5.89	4.74	3.71	3.27	2.20	1.19	

All mentioned values are average values

LC-P1224P

CHARGING METHOD (25°C)

Trickle use Control voltage: 13.6V - 13.8V
Initial current: 3.6A or smaller

CUT-OFF VOLTAGE

Discharge current	1.2A - 4.8A	4.8A - 12A	12A - 24A	24A - 48A	48A - 72A
Cut-off voltage (V)	10.5	10.2	9.9	9.3	8.7

INFLUENCE OF TEMPERATURE ON TRICKLE LIFE

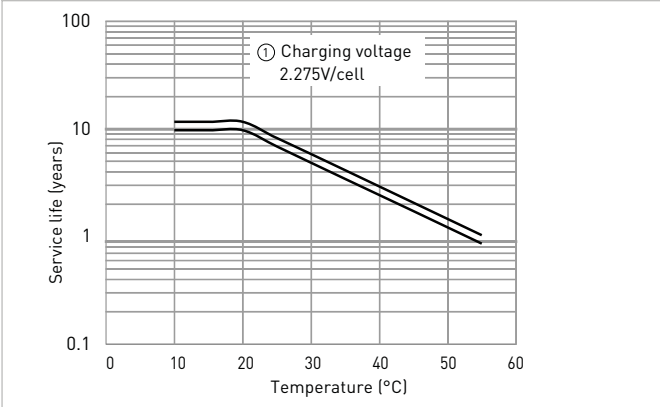

RESIDUAL CAPACITY VS. STORAGE PERIOD

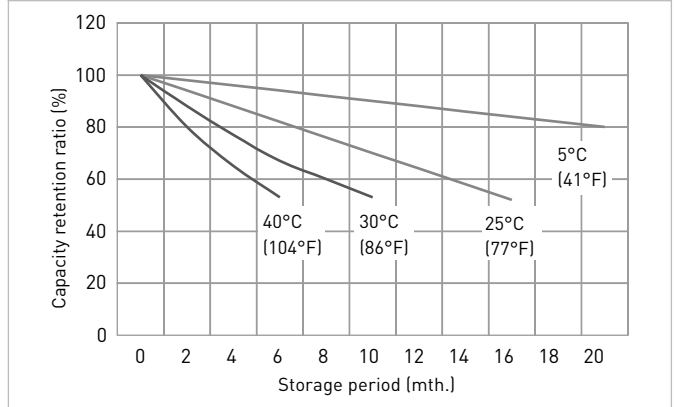

CONSTANT-VOLTAGE CONSTANT-CURRENT CHARGE CHARACTERISTICS FOR TRICKLE USE

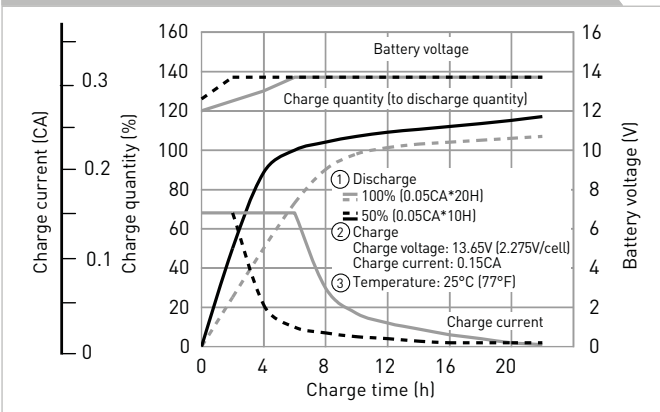

DISCHARGE CAPACITY BY TEMPERATURE AND BY DISCHARGE CURRENT

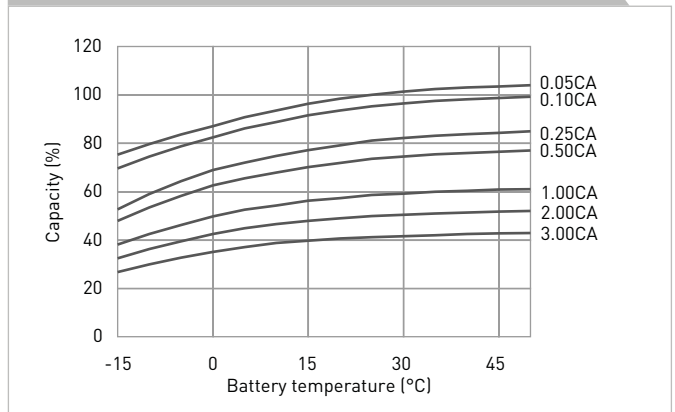

DISCHARGE CHARACTERISTICS

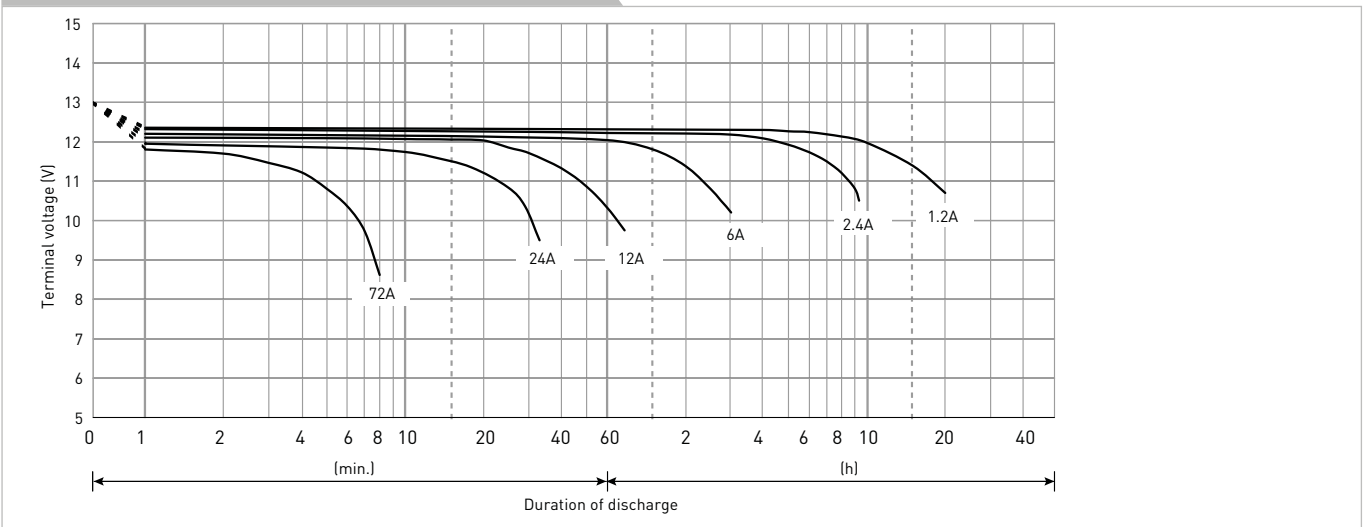

The data in this document are for descriptive purposes only and are not intended to make or imply any guarantee or warranty. Regarding handling and safety please consult our VRLA technical handbook chapter 1.

LC-P1228P

DIMENSIONS (MM)



Contents indicated (including the recycle marking, etc.) are subject to change without notice.

FOR STANDBY POWER SUPPLIES.
EXPECTED TRICKLE DESIGN LIFE: 10 - 12 YEARS AT 20°C
ACCORDING TO EUROBAT.

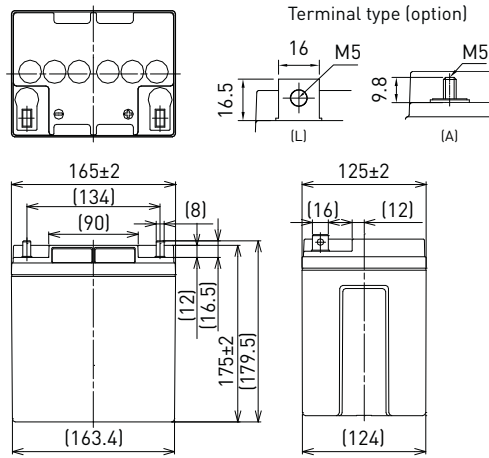

Battery case resin: flame retardant (UL94 V-0)

SPECIFICATIONS		
Name	LC-P1228P/AP	
Nominal voltage	12V	
Nominal capacity (20 hour rate)	28Ah	
Dimensions	Length	165mm
	Width	125mm
	Height	175mm/179.5mm
Approx. mass	9.40kg	
Terminal	M5 bolt/nut & threaded post	
Capacity (25°C)	20 hour rate	28Ah
	10 hour rate	26Ah
	3 hour rate	22Ah
	1 hour rate	21Ah
Impedance	Fully charged battery (25°C)	11mΩ
Temperature dependency of capacity (20 hour rate)	40°C	102%
	25°C	100%
	0°C	85%
	-15°C	65%
Remaining capacity (25°C)	After 3 month	91%
	After 6 month	82%
	After 12 month	64%

DURATION OF DISCHARGE VS. DISCHARGE CURRENT

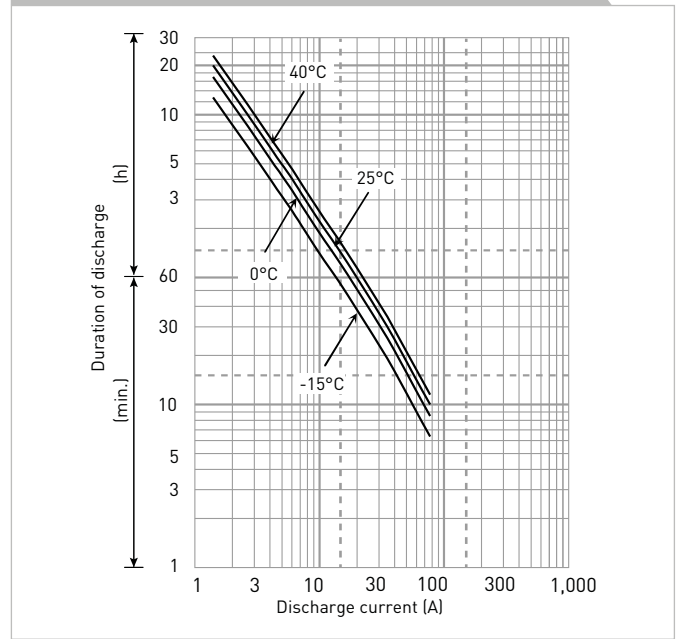

WATT TABLE (25°C)															[Wattage/battery]	
Cut-off	5min.	10min.	15min.	20min.	30min.	45min.	1h	1.5h	2h	3h	4h	5h	6h	10h	20h	
9.6V	1,160	865	664	585	410	304	260	159	129	91.6	74.1	61.1	50.8	31.8	16.8	
9.9V	1,093	849	654	579	404	294	254	156	128	90.4	72.9	60.8	50.4	31.8	16.8	
10.2V	1,026	818	643	567	397	288	251	155	127	89.3	71.7	60.5	49.9	31.8	16.8	
10.5V	976	784	621	545	386	282	247	154	126	88.1	71.1	60.2	49.5	31.8	16.8	
10.8V	903	773	610	539	374	255	218	149	118	84.5	70.5	59.9	49.0	31.8	16.8	

AMPERE TABLE (25°C)															[Ampere/battery]	
Cut-off	5min.	10min.	15min.	20min.	30min.	45min.	1h	1.5h	2h	3h	4h	5h	6h	10h	20h	
9.6V	104	77.2	57.7	50.4	35.0	25.9	22.1	13.5	10.9	7.70	6.20	5.10	4.30	2.60	1.40	
9.9V	98.0	75.8	56.9	49.9	34.5	25.0	21.6	13.2	10.8	7.60	6.10	5.06	4.28	2.60	1.40	
10.2V	92.0	73.0	55.9	48.9	33.9	24.5	21.3	13.1	10.7	7.50	6.00	5.03	4.25	2.60	1.40	
10.5V	87.5	70.0	54.0	47.0	33.0	24.0	21.0	13.0	10.6	7.40	5.95	4.99	4.23	2.60	1.40	
10.8V	81.0	69.0	53.0	46.5	32.0	21.7	18.5	12.6	10.0	7.10	5.90	4.95	4.20	2.60	1.40	

All mentioned values are average values

LC-P1228P

CHARGING METHOD (25°C)

Trickle use Control voltage: 13.6V - 13.8V
Initial current: 4.20A or smaller

CUT-OFF VOLTAGE

Discharge current	1.40A - 5.60A	5.60A - 14.0A	14.0A - 28.0A	28.0A - 56.0A	56.0A - 84.0A
Cut-off voltage	10.5V	10.2V	9.9V	9.3V	8.7V

INFLUENCE OF TEMPERATURE ON TRICKLE LIFE

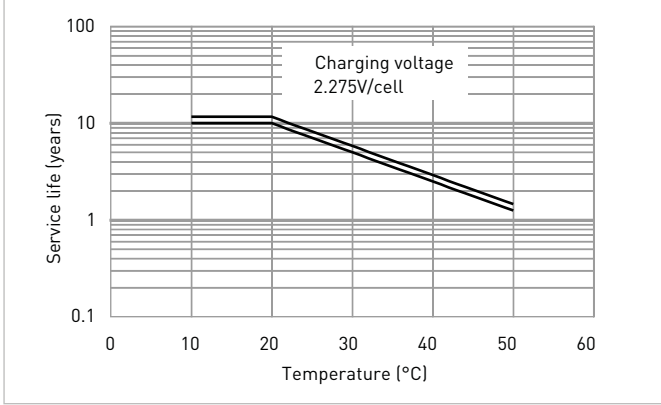

RESIDUAL CAPACITY TEST RESULT

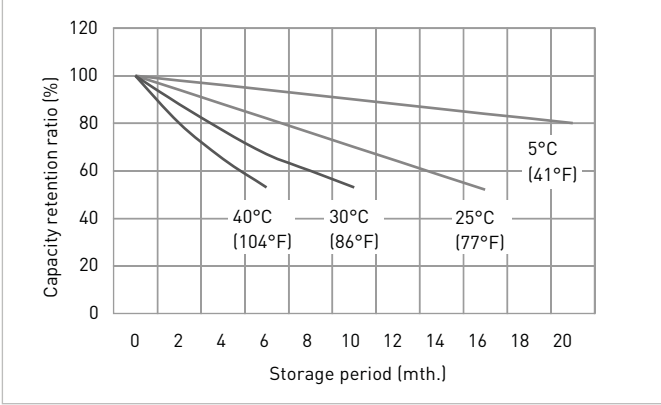

CONSTANT-VOLTAGE CONSTANT-CURRENT CHARGE CHARACTERISTICS FOR TRICKLE USE

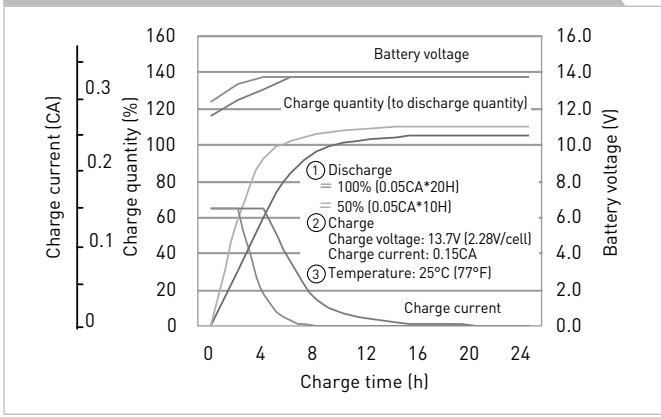

DISCHARGE CAPACITY BY TEMPERATURE AND BY DISCHARGE CURRENT

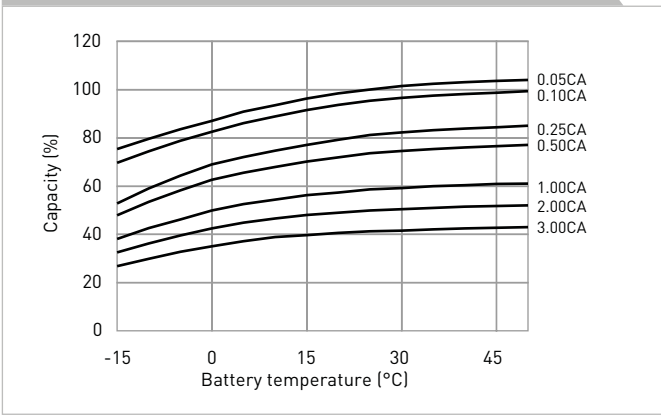

DISCHARGE CHARACTERISTICS

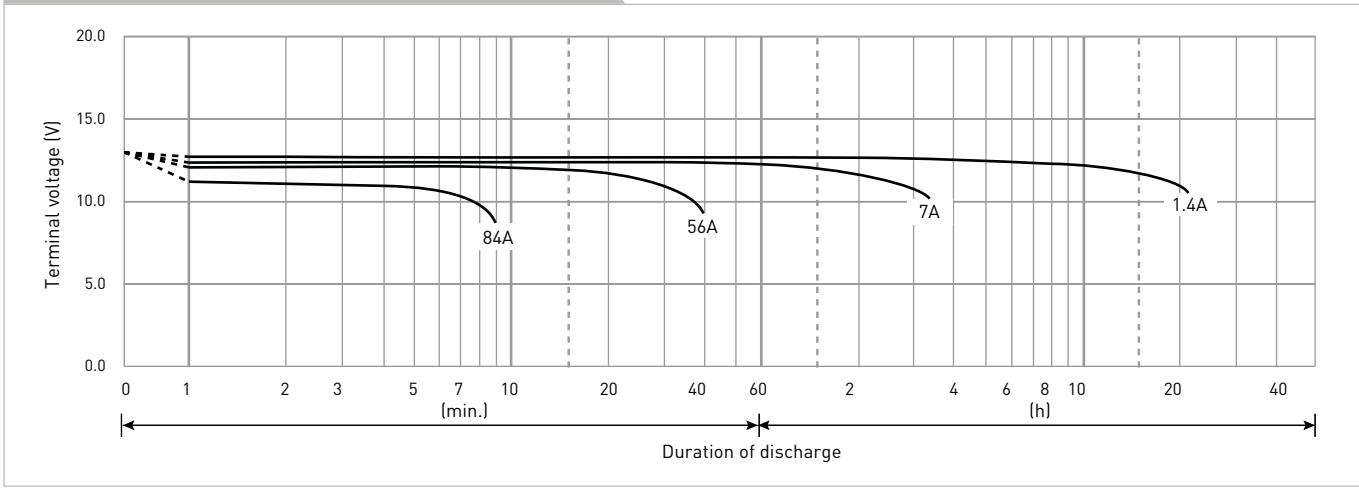

The data in this document are for descriptive purposes only and are not intended to make or imply any guarantee or warranty. Regarding handling and safety please consult our VRLA technical handbook chapter 1.

LC-P122R2P

DIMENSIONS (MM)



FOR STANDBY POWER SUPPLIES.
EXPECTED TRICKLE DESIGN LIFE: 10 - 12 YEARS AT 20°C
ACCORDING TO EUROBAT.

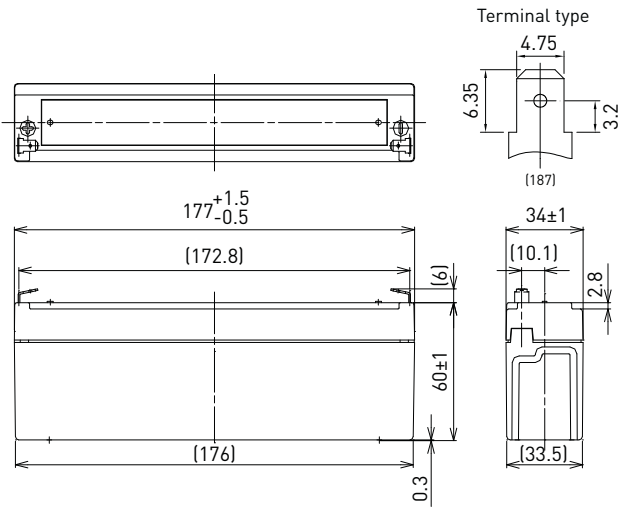

Contents indicated (including the recycle marking, etc.) are subject to change without notice.

Battery case resin: flame retardant (UL94 V-0)

SPECIFICATIONS		
Name	LC-P122R2P	
Nominal voltage	12V	
Nominal capacity (20 hour rate)	2.2Ah	
Dimensions	Length	177mm
	Width	34mm
	Height	66mm
Approx. mass	0.80kg	
Terminal	Faston 187	
Capacity (25°C)	20 hour rate	2.2Ah
	10 hour rate	2.0Ah
	3 hour rate	1.8Ah
	1 hour rate	1.5Ah
Impedance	Fully charged battery (25°C)	70mΩ
Temperature dependency of capacity (20 hour rate)	40°C	102%
	25°C	100%
	0°C	85%
	-15°C	65%
Remaining capacity (25°C)	After 3 month	91%
	After 6 month	82%
	After 12 month	64%

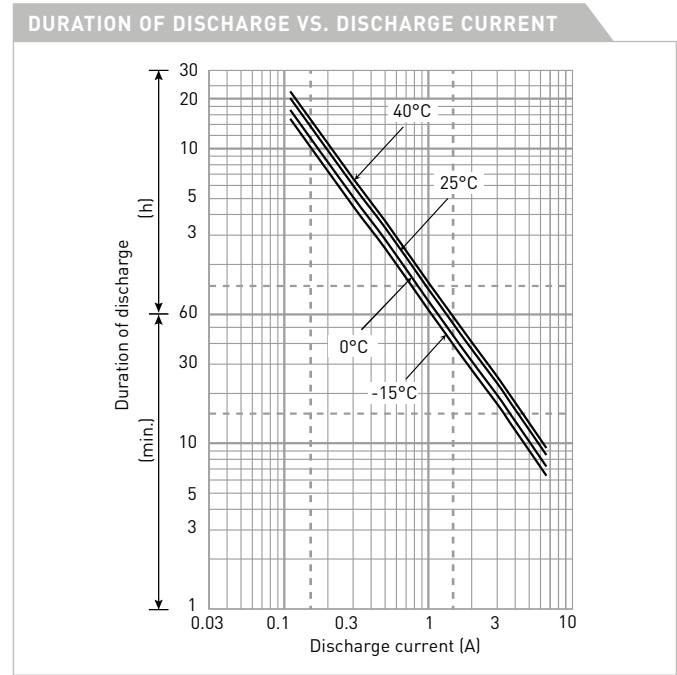

WATT TABLE (25°C)																[Wattage/battery]	
Cut-off	3min.	5min.	10min.	15min.	20min.	30min.	45min.	1h	1.5h	2h	3h	4h	5h	6h	10h	20h	
9.6V	132	104	68.1	52.0	43.6	32.5	23.0	18.4	12.6	9.77	7.27	5.59	4.61	3.71	2.46	1.33	
9.9V	123	97.8	66.7	51.7	42.9	32.2	22.8	18.4	12.4	9.70	7.24	5.55	4.58	3.69	2.45	1.33	
10.2V	113	91.6	65.0	50.6	42.2	31.8	22.6	18.0	12.1	9.44	7.16	5.51	4.54	3.66	2.42	1.32	
10.5V	101	82.1	60.2	47.1	40.1	31.1	22.2	17.6	11.9	9.12	7.05	5.48	4.50	3.62	2.41	1.32	
10.8V	85	72.6	53.7	43.9	39.0	30.0	21.9	17.3	11.5	8.68	6.91	5.40	4.39	3.56	2.38	1.31	

AMPERE TABLE (25°C)																[Ampere/battery]	
Cut-off	3min.	5min.	10min.	15min.	20min.	30min.	45min.	1h	1.5h	2h	3h	4h	5h	6h	10h	20h	
9.6V	11.9	9.35	6.08	4.52	3.76	2.78	1.96	1.56	1.07	0.825	0.611	0.468	0.385	0.309	0.205	0.111	
9.9V	11.0	8.77	5.96	4.49	3.70	2.75	1.94	1.56	1.05	0.819	0.608	0.464	0.382	0.308	0.204	0.111	
10.2V	10.2	8.22	5.81	4.40	3.64	2.72	1.93	1.53	1.03	0.798	0.602	0.461	0.379	0.306	0.202	0.110	
10.5V	9.0	7.36	5.38	4.09	3.45	2.66	1.89	1.50	1.01	0.770	0.593	0.458	0.376	0.302	0.201	0.110	
10.8V	7.6	6.51	4.80	3.82	3.36	2.57	1.86	1.47	0.98	0.733	0.581	0.452	0.367	0.297	0.199	0.109	

All mentioned values are average values

LC-P122R2P

CHARGING METHOD (25°C)

Trickle use	Control voltage: 13.6V - 13.8V Initial current: 0.33A or smaller
--------------------	---

CUT-OFF VOLTAGE

Discharge current	0.011A - 0.44A	0.44A - 1.1A	1.1A - 2.2A	2.2A - 4.4A	4.4A - 6.6A
Cut-off voltage	10.5V	10.2V	9.9V	9.3V	8.7V

INFLUENCE OF TEMPERATURE ON TRICKLE LIFE

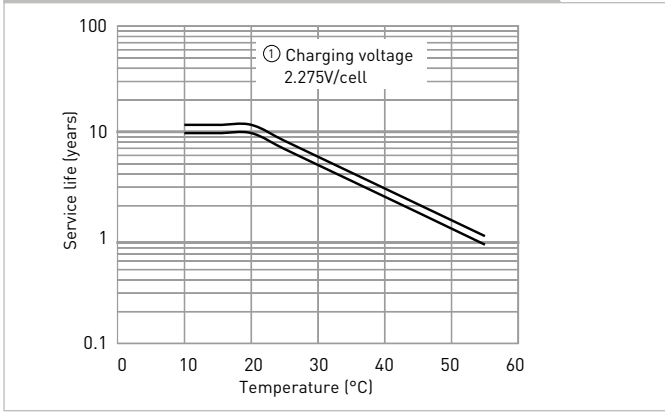

RESIDUAL CAPACITY VS. STORAGE PERIOD

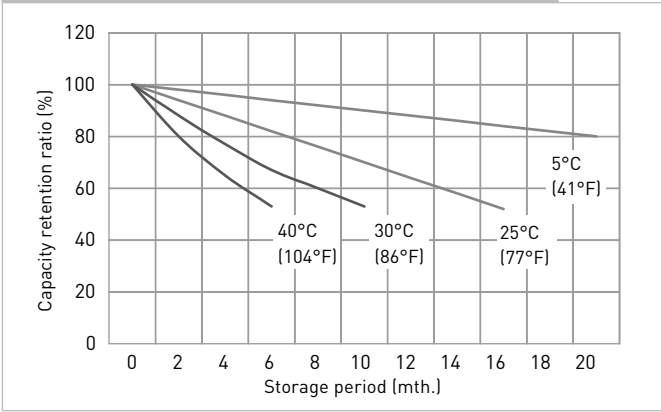

CONSTANT-VOLTAGE CONSTANT-CURRENT CHARGE CHARACTERISTICS FOR TRICKLE USE

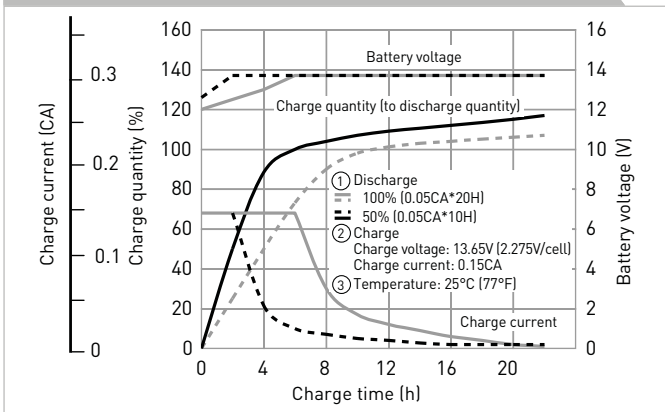

DISCHARGE CAPACITY BY TEMPERATURE AND BY DISCHARGE CURRENT

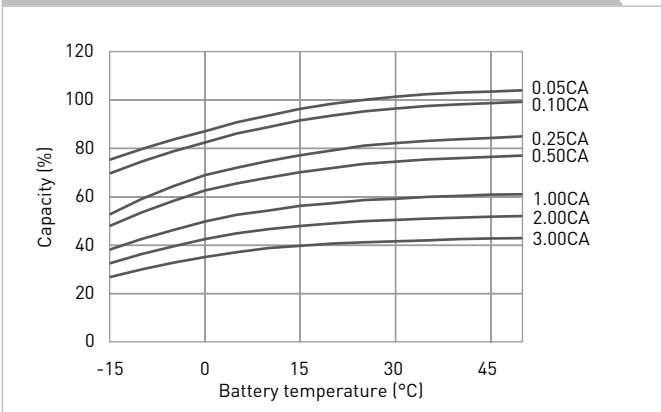

DISCHARGE CHARACTERISTICS

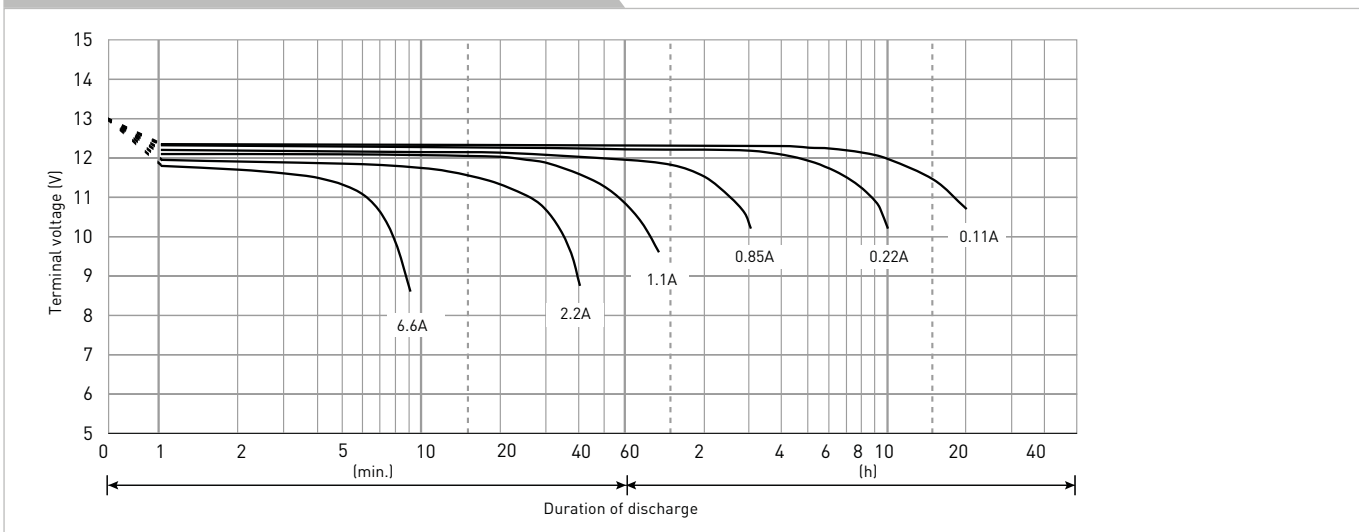

The data in this document are for descriptive purposes only and are not intended to make or imply any guarantee or warranty. Regarding handling and safety please consult our VRLA technical handbook chapter 1.

LC-P1238P

DIMENSIONS (MM)



Contents indicated (including the recycle marking, etc.) are subject to change without notice.

FOR STANDBY POWER SUPPLIES.
EXPECTED TRICKLE DESIGN LIFE: 10 - 12 YEARS
AT 20°C ACCORDING TO EUROBAT.



G100002

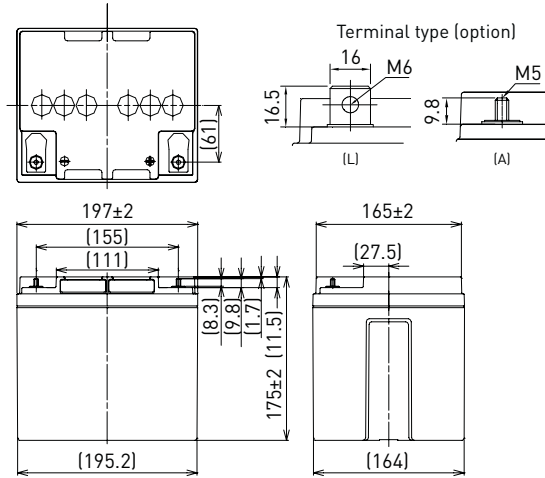

Battery case resin: flame retardant (UL94 V-0)

SPECIFICATIONS		
Name	LC-P1238PG/APG	
Nominal voltage	12V	
Nominal capacity (20 hour rate)	38Ah	
Dimensions	Length	197mm
	Width	165mm
	Height	175mm/180mm
Approx. mass	12.5kg	
Terminal	M6 bolt/nut & M5 threaded post	
Capacity (25°C)	20 hour rate	38Ah
	10 hour rate	36Ah
	3 hour rate	29Ah
	1 hour rate	23Ah
Impedance	Fully charged battery (25°C)	10mΩ
Temperature dependency of capacity (20 hour rate)	40°C	102%
	25°C	100%
	0°C	85%
	-15°C	65%
Remaining capacity (25°C)	After 3 month	91%
	After 6 month	82%
	After 12 month	64%

DURATION OF DISCHARGE VS. DISCHARGE CURRENT

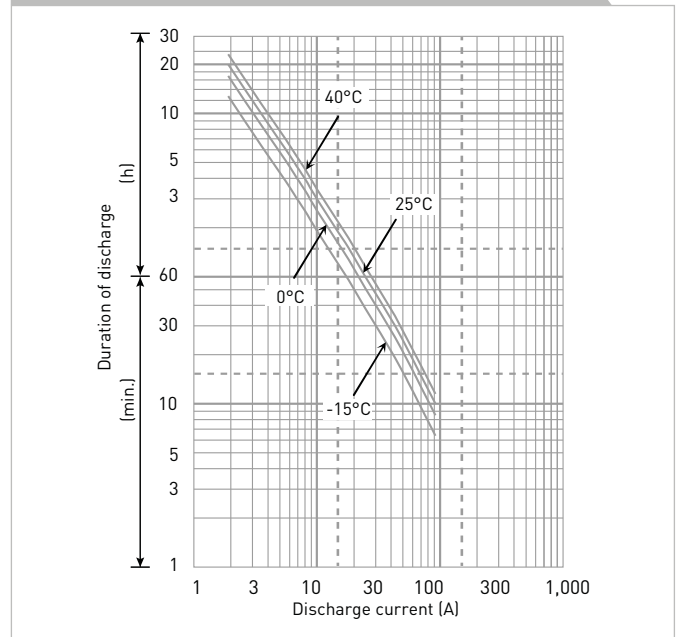

WATT TABLE (25°C)															[Wattage/battery]	
Cut-off	5min.	10min.	15min.	20min.	30min.	45min.	1h	1.5h	2h	3h	4h	5h	6h	10h	20h	
9.6V	1,349	1,030	800	686	505	351	276	214	169	123	99.2	77.9	68.3	42.0	22.8	
9.9V	1,271	1,008	788	682	500	350	269	209	168	120	98.0	76.7	68.0	42.0	22.8	
10.2V	1,204	980	768	672	489	349	267	185	167	119	96.8	75.5	67.7	42.0	22.8	
10.5V	1,126	952	748	661	480	346	265	183	166	117	95.6	74.9	67.4	42.0	22.8	
10.8V	1,098	874	716	640	468	308	247	175	155	114	94.4	74.3	67.1	42.0	22.8	

AMPERE TABLE (25°C)															[Ampere/battery]	
Cut-off	5min.	10min.	15min.	20min.	30min.	45min.	1h	1.5h	2h	3h	4h	5h	6h	10h	20h	
9.6V	121	92.0	69.6	59.1	43.2	29.9	23.4	18.1	14.3	10.3	8.30	6.50	5.70	3.60	1.90	
9.9V	114	90.0	68.5	58.8	42.7	29.8	22.8	17.7	14.2	10.1	8.20	6.40	5.68	3.60	1.90	
10.2V	108	87.5	66.8	57.9	41.8	29.7	22.7	15.7	14.1	10.0	8.10	6.30	5.66	3.60	1.90	
10.5V	101	85.0	65.0	57.0	41.0	29.5	22.5	15.5	14.0	9.80	8.00	6.25	5.64	3.60	1.90	
10.8V	98.5	78.0	62.3	55.2	40.0	26.2	21.0	14.8	13.1	9.60	7.90	6.20	5.60	3.60	1.90	

All mentioned values are average values

LC-P1238P

CHARGING METHOD (25°C)

Trickle use Control voltage: 13.6V - 13.8V
Initial current: 5.70A or smaller

CUT-OFF VOLTAGE

Discharge current	1.90A - 7.60A	7.60A - 19.0A	19.0A - 38.0A	38.0A - 76.0A	76.0A - 114A
Cut-off voltage	10.5V	10.2V	9.9V	9.3V	8.7V

INFLUENCE OF TEMPERATURE ON TRICKLE LIFE

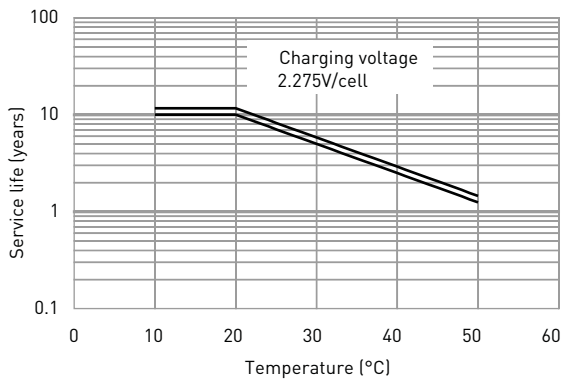

RESIDUAL CAPACITY TEST RESULT

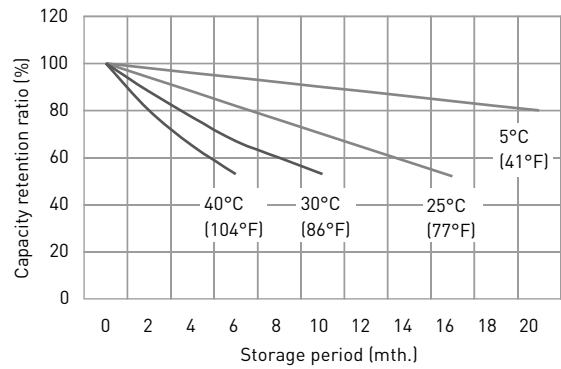

CONSTANT-VOLTAGE CONSTANT-CURRENT CHARGE CHARACTERISTICS FOR TRICKLE USE

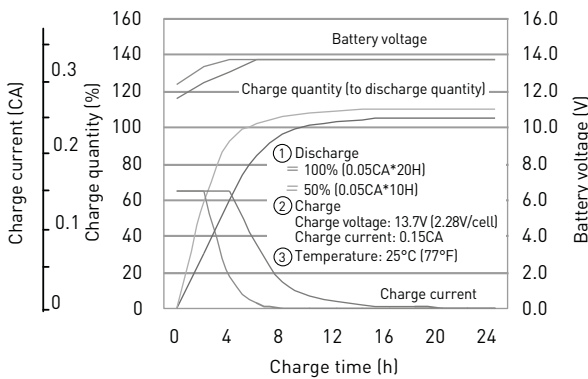

DISCHARGE CAPACITY BY TEMPERATURE AND BY DISCHARGE CURRENT

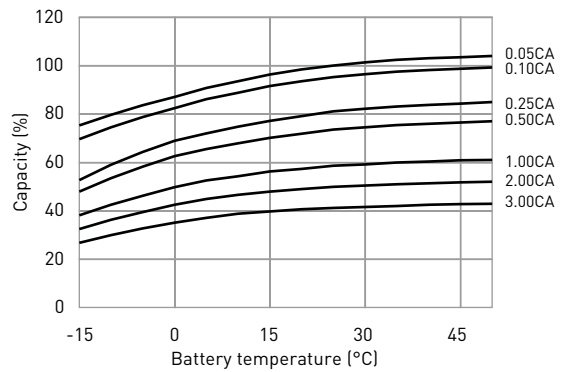

DISCHARGE CHARACTERISTICS

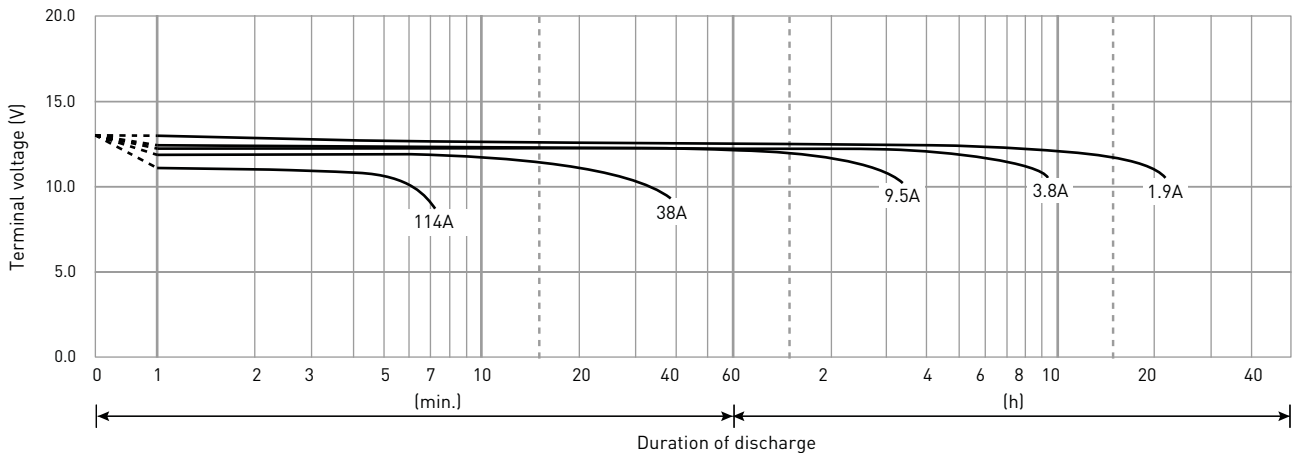

The data in this document are for descriptive purposes only and are not intended to make or imply any guarantee or warranty. Regarding handling and safety please consult our VRLA technical handbook chapter 1.

LC-P123R4P

DIMENSIONS (MM)



FOR STANDBY POWER SUPPLIES.
EXPECTED TRICKLE DESIGN LIFE: 10 - 12 YEARS AT 20°C
ACCORDING TO EUROBAT.

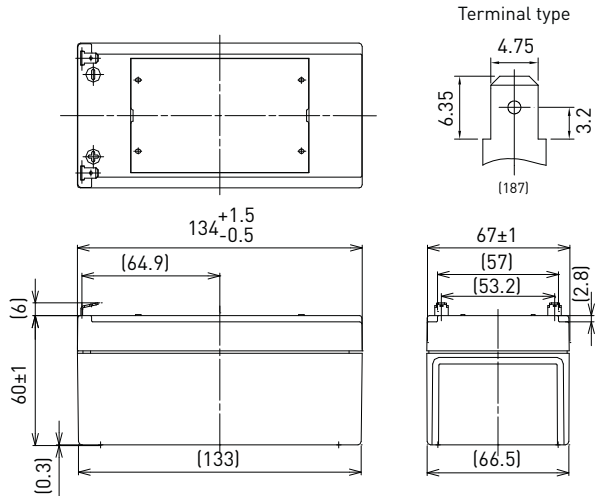

Contents indicated (including the recycle marking, etc.) are subject to change without notice.

Battery case resin: flame retardant (UL94 V-0)

SPECIFICATIONS		
Name	LC-P123R4P	
Nominal voltage	12V	
Nominal capacity (20 hour rate)	3.4Ah	
Dimensions	Length	134mm
	Width	67mm
	Height	66mm
Approx. mass	1.15kg	
Terminal	Faston 187	
Capacity (25°C)	20 hour rate	3.4Ah
	10 hour rate	3.1Ah
	3 hour rate	2.8Ah
	1 hour rate	2.3Ah
Impedance	Fully charged battery (25°C)	50mΩ
	40°C	102%
Temperature dependency of capacity (20 hour rate)	25°C	100%
	0°C	85%
	-15°C	65%
Remaining capacity (25°C)	After 3 month	91%
	After 6 month	82%
	After 12 month	64%

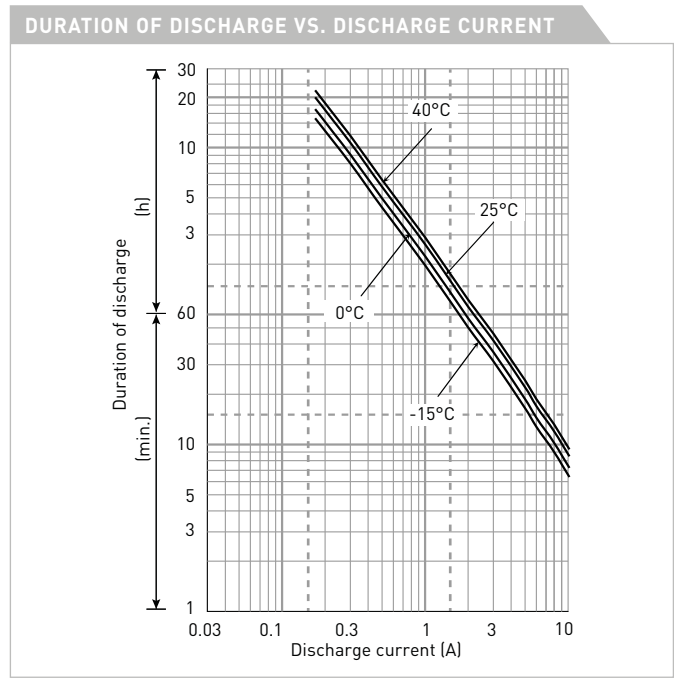

WATT TABLE (25°C)																(Wattage/battery)
Cut-off	3min.	5min.	10min.	15min.	20min.	30min.	45min.	1h	1.5h	2h	3h	4h	5h	6h	10h	20h
9.6V	204	161	105	80.4	67.4	50.3	35.5	28.4	19.6	15.0	11.3	8.63	7.13	5.80	3.81	2.06
9.9V	190	151	103	79.8	66.3	49.7	35.3	28.4	19.2	14.9	11.2	8.58	7.07	5.78	3.80	2.05
10.2V	175	142	100	78.2	65.2	49.2	34.9	27.8	18.8	14.5	11.1	8.52	7.01	5.73	3.76	2.05
10.5V	155	127	93	72.8	61.9	48.1	34.4	27.3	18.4	14.0	11.0	8.46	6.96	5.66	3.74	2.04
10.8V	131	112	83	67.9	60.3	46.4	33.8	26.7	17.8	13.4	10.7	8.46	6.79	5.66	3.68	1.98

AMPERE TABLE (25°C)																(Ampere/battery)
Cut-off	3min.	5min.	10min.	15min.	20min.	30min.	45min.	1h	1.5h	2h	3h	4h	5h	6h	10h	20h
9.6V	18.4	14.4	9.40	6.99	5.81	4.30	3.02	2.41	1.66	1.26	0.949	0.722	0.595	0.484	0.318	0.171
9.9V	17.0	13.6	9.21	6.94	5.71	4.25	3.00	2.41	1.62	1.26	0.945	0.718	0.590	0.482	0.316	0.171
10.2V	15.7	12.7	8.97	6.80	5.62	4.20	2.97	2.36	1.59	1.22	0.935	0.713	0.586	0.478	0.313	0.170
10.5V	14.0	11.4	8.31	6.33	5.34	4.11	2.93	2.31	1.56	1.18	0.921	0.708	0.581	0.472	0.312	0.170
10.8V	11.8	10.1	7.41	5.90	5.19	3.97	2.88	2.27	1.51	1.13	0.897	0.708	0.567	0.472	0.307	0.165

All mentioned values are average values

LC-P123R4P

CHARGING METHOD (25°C)

Trickle use	Control voltage: 13.6V - 13.8V Initial current: 0.51A or smaller
--------------------	---

CUT-OFF VOLTAGE

Discharge current	0.17A - 0.68A	0.68A - 1.7A	1.7A - 3.4A	3.4A - 6.8A	6.8A - 10.2A
Cut-off voltage	10.5V	10.2V	9.9V	9.3V	8.7V

INFLUENCE OF TEMPERATURE ON TRICKLE LIFE

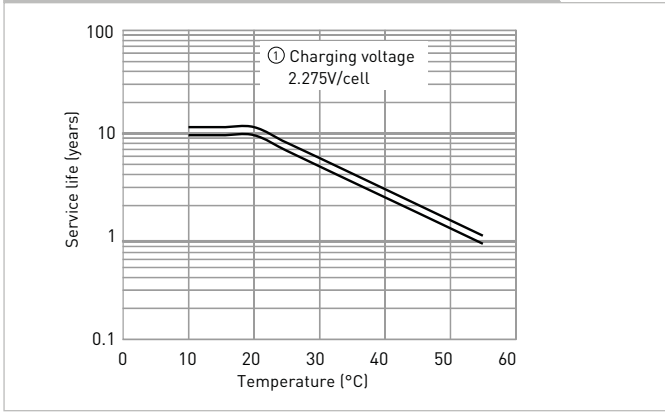

RESIDUAL CAPACITY VS. STORAGE PERIOD

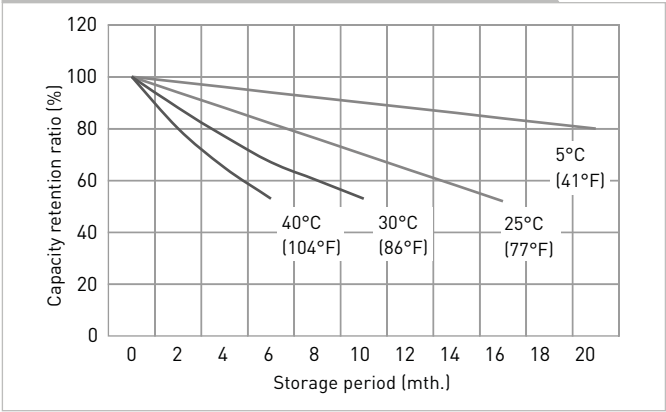

CONSTANT-VOLTAGE CONSTANT-CURRENT CHARGE CHARACTERISTICS FOR TRICKLE USE

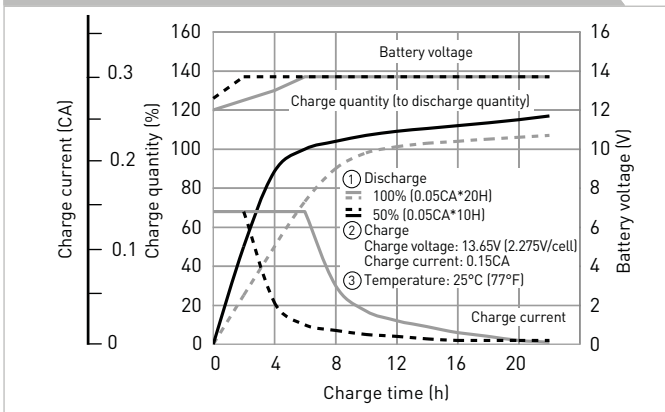

DISCHARGE CAPACITY BY TEMPERATURE AND BY DISCHARGE CURRENT

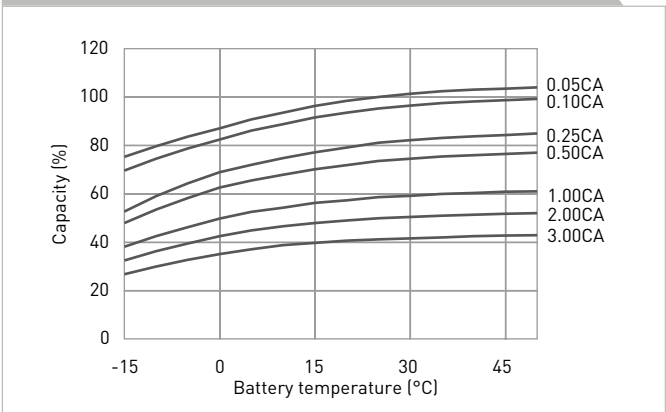

DISCHARGE CHARACTERISTICS

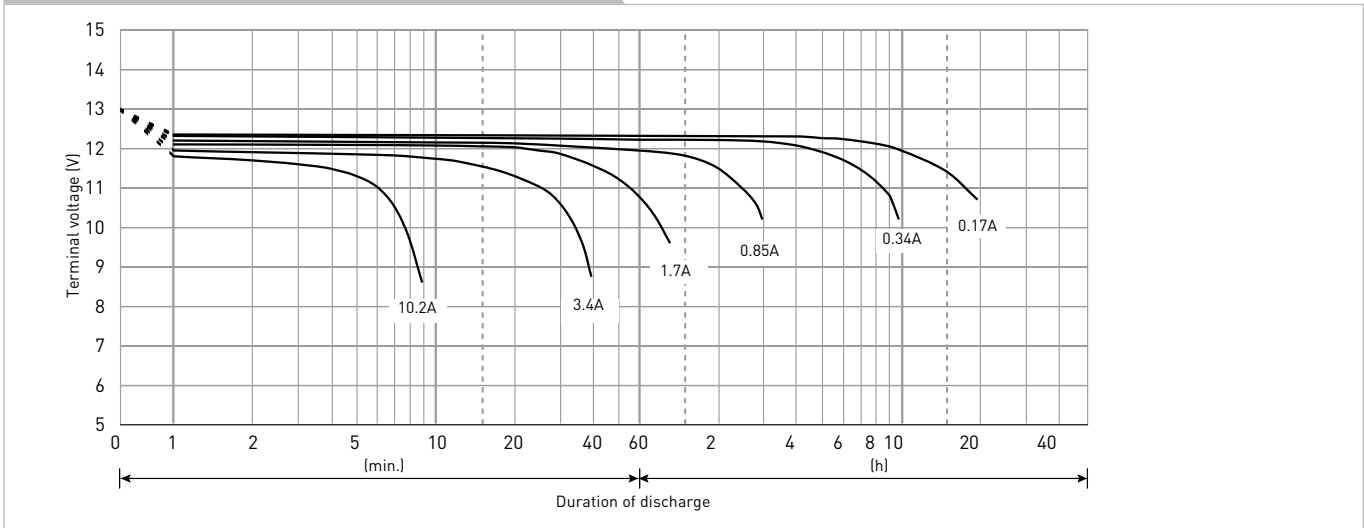

The data in this document are for descriptive purposes only and are not intended to make or imply any guarantee or warranty. Regarding handling and safety please consult our VRLA technical handbook chapter 1.

LC-P1242P

DIMENSIONS (MM)



Contents indicated (including the recycle marking, etc.) are subject to change without notice.

FOR STANDBY POWER SUPPLIES.
EXPECTED TRICKLE DESIGN LIFE: 10 - 12 YEARS AT 20°C
ACCORDING TO EUROBAT.

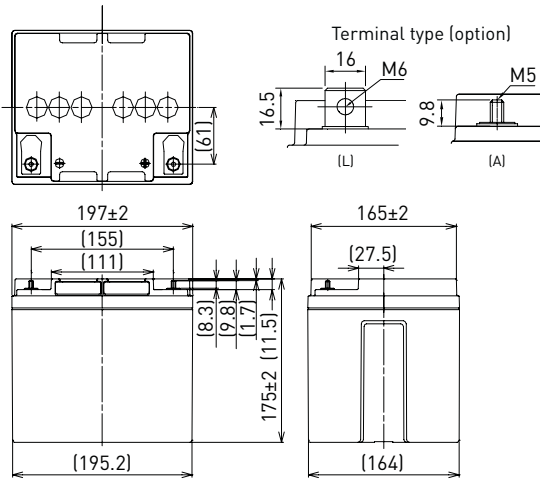

Battery case resin: flame retardant (UL94 V-0)

SPECIFICATIONS	
Name	LC-P1242P/AP
Nominal voltage	12V
Nominal capacity (20 hour rate)	42Ah
Dimensions	Length 197mm
	Width 165mm
	Height 175mm/180mm
Approx. mass	13.5kg
Terminal	M6 bolt/nut & M5 threaded post
Capacity (25°C)	20 hour rate 42Ah
	10 hour rate 40Ah
	3 hour rate 32Ah
	1 hour rate 26Ah
Impedance	Fully charged battery (25°C) 10mΩ
	40°C 102%
Temperature dependency of capacity (20 hour rate)	25°C 100%
	0°C 85%
	-15°C 65%
Remaining capacity (25°C)	After 3 month 91%
	After 6 month 82%
	After 12 month 64%

DURATION OF DISCHARGE VS. DISCHARGE CURRENT

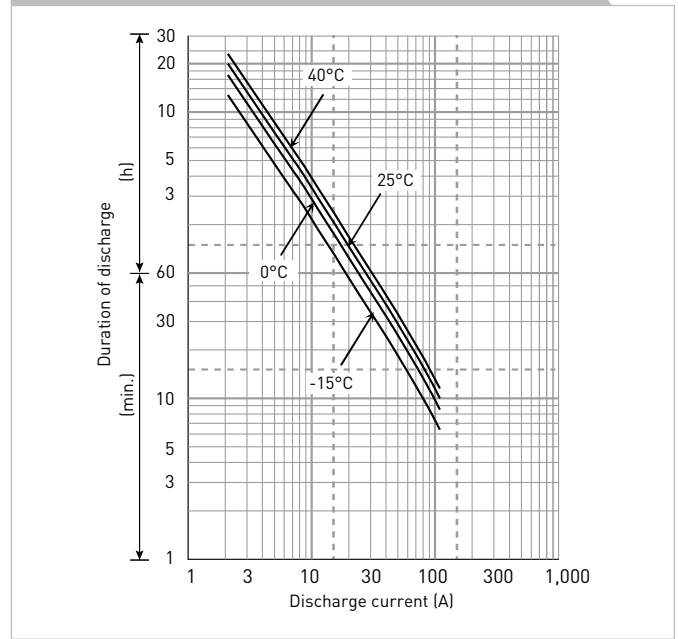

WATT TABLE (25°C)													[Wattage/battery]			
Cut-off	5min.	10min.	15min.	20min.	30min.	45min.	1h	1.5h	2h	3h	4h	5h	6h	10h	20h	
9.6V	1,483	1,254	966	835	625	410	312	241	187	132	110	89.9	79.1	48.0	25.2	
9.9V	1,405	1,232	955	824	607	407	310	234	186	130	109	89.4	78.5	48.0	25.2	
10.2V	1,327	1,210	943	812	596	406	307	217	184	127	108	88.9	77.9	48.0	25.2	
10.5V	1,249	1,176	920	800	585	405	306	211	179	126	107	88.5	76.7	48.0	25.2	
10.8V	1,215	1,086	886	777	573	390	295	201	173	121	105	87.5	75.5	48.0	25.2	

AMPERE TABLE (25°C)													[Ampere/battery]			
Cut-off	5min.	10min.	15min.	20min.	30min.	45min.	1h	1.5h	2h	3h	4h	5h	6h	10h	20h	
9.6V	133	112	84.0	72.0	53.4	34.9	26.5	20.4	15.8	11.1	9.20	7.50	6.60	4.00	2.10	
9.9V	126	110	83.0	71.0	51.9	34.7	26.3	19.8	15.7	10.9	9.10	7.46	6.50	4.00	2.10	
10.2V	119	108	82.0	70.0	50.9	34.6	26.1	18.4	15.5	10.7	9.00	7.42	6.50	4.00	2.10	
10.5V	112	105	80.0	69.0	50.0	34.5	26.0	17.9	15.1	10.6	8.90	7.38	6.40	4.00	2.10	
10.8V	109	97.0	77.0	67.0	49.0	33.2	25.0	17.0	14.6	10.2	8.80	7.30	6.30	4.00	2.10	

All mentioned values are average values

LC-P1242P

CHARGING METHOD (25°C)

Trickle use Control voltage: 13.6V - 13.8V
Initial current: 6.30A or smaller

CUT-OFF VOLTAGE

Discharge current	2.10A - 8.40A	8.40A - 21.0A	21.0A - 42.0A	42.0A - 84.0A	84.0A - 126A
Cut-off voltage	10.5V	10.2V	9.9V	9.3V	8.7V

INFLUENCE OF TEMPERATURE ON TRICKLE LIFE

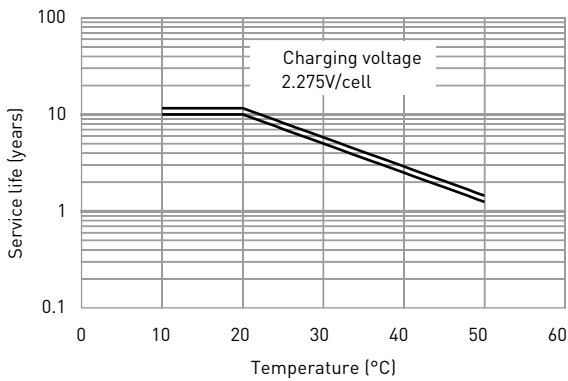

RESIDUAL CAPACITY TEST RESULT

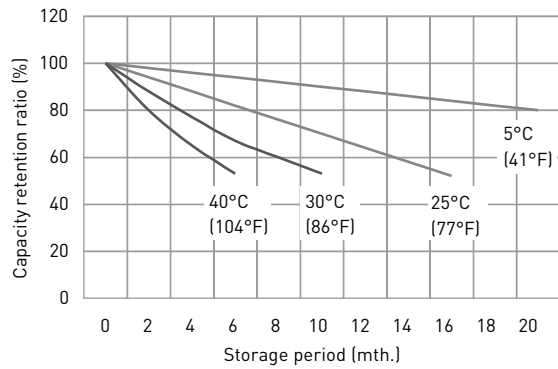

CONSTANT-VOLTAGE CONSTANT-CURRENT CHARGE CHARACTERISTICS FOR TRICKLE USE

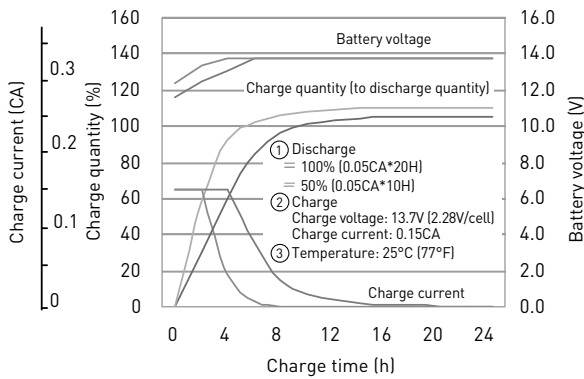

DISCHARGE CAPACITY BY TEMPERATURE AND BY DISCHARGE CURRENT

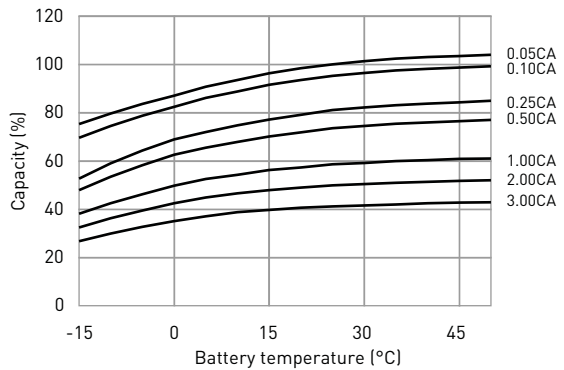

DISCHARGE CHARACTERISTICS

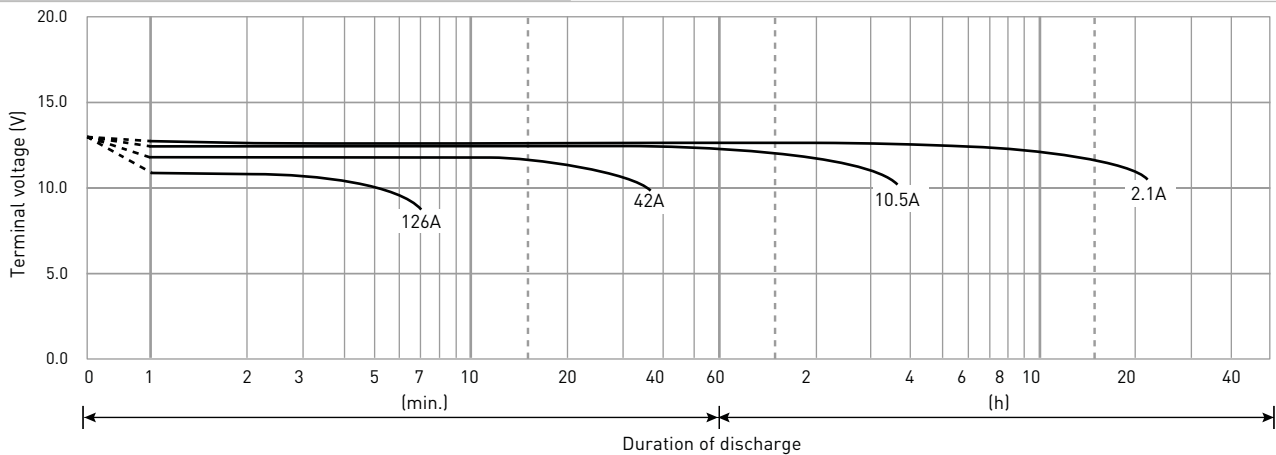

The data in this document are for descriptive purposes only and are not intended to make or imply any guarantee or warranty. Regarding handling and safety please consult our VRLA technical handbook chapter 1.

LC-P1275P

DIMENSIONS (MM)



Contents indicated (including the recycle marking, etc.) are subject to change without notice.

FOR STANDBY POWER SUPPLIES.
EXPECTED TRICKLE DESIGN LIFE: 10 - 12 YEARS AT 20°C
ACCORDING TO EUROBAT.

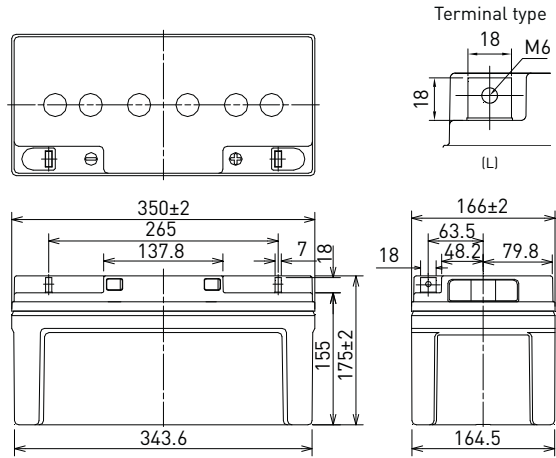

Battery case resin: flame retardant (UL94 V-0)

SPECIFICATIONS		
Name	LC-P1275P	
Nominal voltage	12V	
Nominal capacity (20 hour rate)	75Ah	
Dimensions	Length	350mm
	Width	166mm
	Height	175mm
Approx. mass	21.5kg	
Terminal	M6 bolt/nut	
Capacity (25°C)	20 hour rate	75Ah
	10 hour rate	70Ah
	3 hour rate	53Ah
	1 hour rate	50Ah
Impedance	Fully charged battery (25°C)	7mΩ
Temperature dependency of capacity (20 hour rate)	40°C	102%
	25°C	100%
	0°C	85%
	-15°C	65%
Remaining capacity (25°C)	After 3 month	91%
	After 6 month	82%
	After 12 month	64%

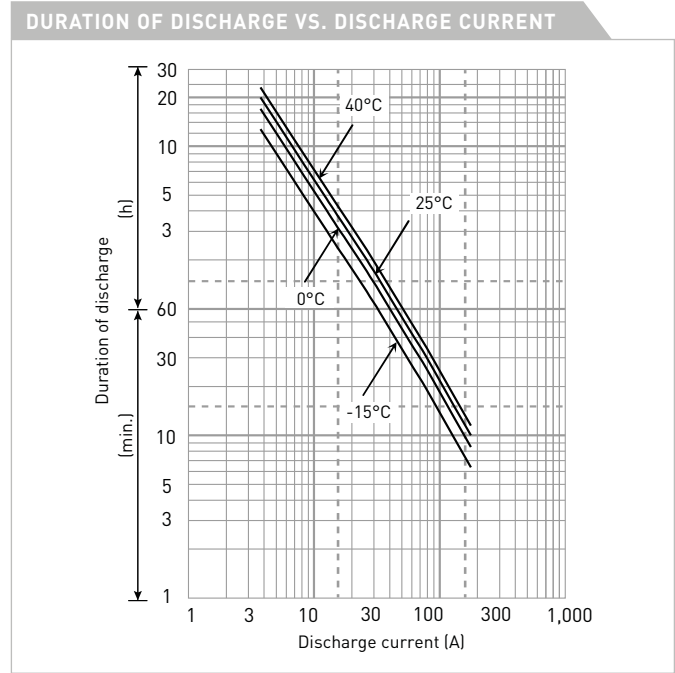

WATT TABLE (25°C)															[Wattage/battery]	
Cut-off	5min.	10min.	15min.	20min.	30min.	45min.	1h	1.5h	2h	3h	4h	5h	6h	10h	20h	
9.6V	2,273	1,985	1,546	1,313	962	702	555	411	327	220	171	149	125	79.5	45.0	
9.9V	2,233	1,950	1,538	1,306	955	683	553	403	325	216	169	147	124	79.1	45.0	
10.2V	2,093	1,827	1,531	1,290	940	679	549	400	321	215	168	146	123	78.6	45.0	
10.5V	1,875	1,637	1,446	1,230	925	671	546	395	317	210	166	144	122	78.2	45.0	
10.8V	1,657	1,447	1,400	1,200	911	580	473	355	301	205	164	143	120	77.8	44.1	

AMPERE TABLE (25°C)															[Ampere/battery]	
Cut-off	5min.	10min.	15min.	20min.	30min.	45min.	1h	1.5h	2h	3h	4h	5h	6h	10h	20h	
9.6V	241	177	134	116	86.9	61.5	51.0	34.8	27.6	18.5	14.3	12.4	10.4	7.14	3.75	
9.9V	237	175	132	113	86.3	59.9	50.8	34.1	27.4	18.2	14.2	12.2	10.3	7.11	3.75	
10.2V	222	167	130	111	84.9	59.5	50.5	33.8	27.1	18.1	14.0	12.1	10.2	7.07	3.75	
10.5V	199	159	126	109	83.6	58.9	50.2	33.4	26.8	17.7	13.9	12.0	10.1	7.04	3.75	
10.8V	176	151	122	106	82.3	50.8	43.5	30.1	25.4	17.3	13.7	11.9	10.0	7.00	3.68	

All mentioned values are average values

LC-P1275P

CHARGING METHOD (25°C)

Trickle use	Control voltage: 13.6V - 13.8V Initial current: 11.3A or smaller
--------------------	---

CUT-OFF VOLTAGE

Discharge current	3.75A - 15.0A	15.0A - 37.5A	37.5A - 75.0A	75.0A - 150A	150A - 225A
Cut-off voltage	10.5V	10.2V	9.9V	9.3V	8.7V

INFLUENCE OF TEMPERATURE ON TRICKLE LIFE

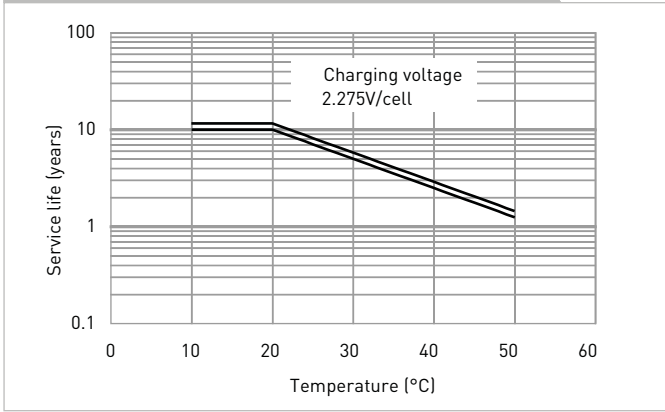

RESIDUAL CAPACITY TEST RESULT

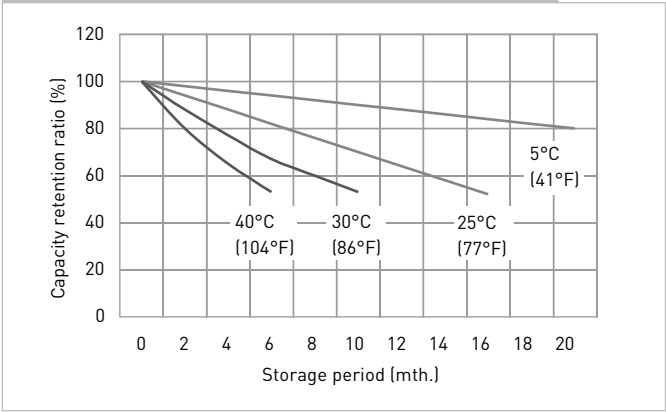

CONSTANT-VOLTAGE CONSTANT-CURRENT CHARGE CHARACTERISTICS FOR TRICKLE USE

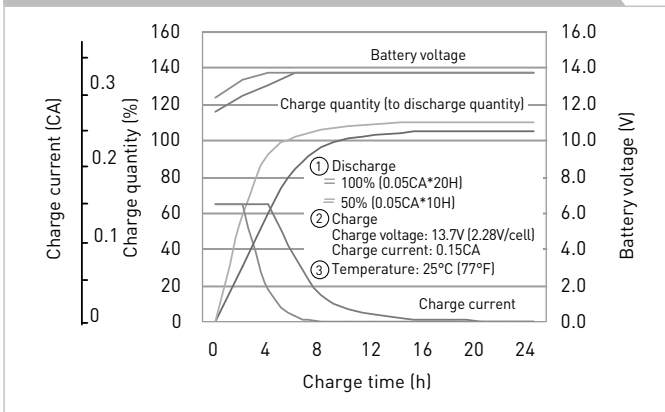

DISCHARGE CAPACITY BY TEMPERATURE AND BY DISCHARGE CURRENT

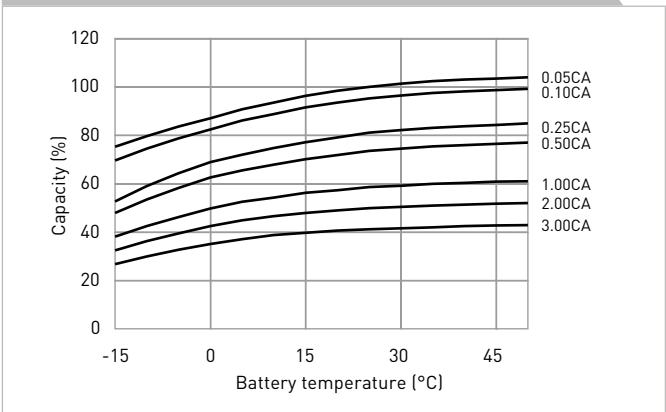

DISCHARGE CHARACTERISTICS

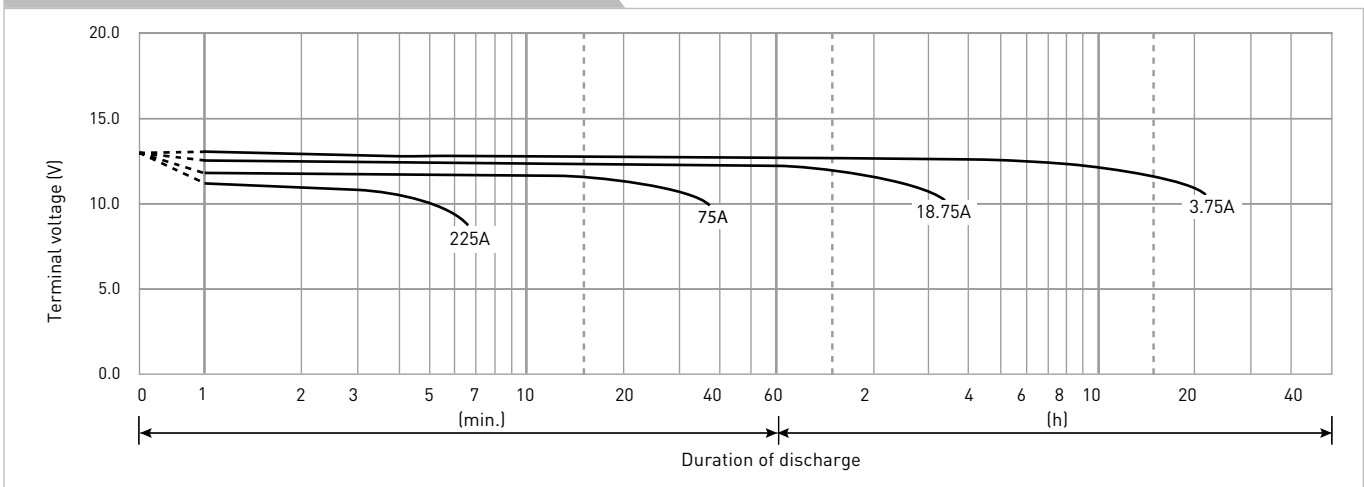

The data in this document are for descriptive purposes only and are not intended to make or imply any guarantee or warranty. Regarding handling and safety please consult our VRLA technical handbook chapter 1.

LC-P127R2P

DIMENSIONS (MM)



FOR STANDBY POWER SUPPLIES.
EXPECTED TRICKLE DESIGN LIFE: 10 - 12 YEARS AT 20°C
ACCORDING TO EUROBAT.

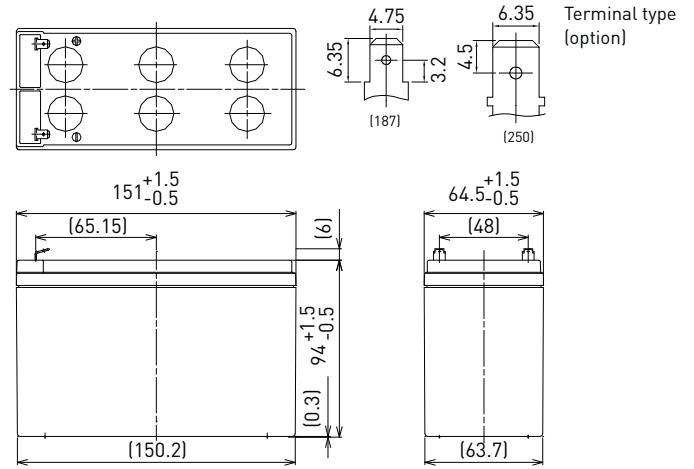

Contents indicated (including the recycle marking, etc.) are subject to change without notice.

Battery case resin: flame retardant (UL94 V-0)

SPECIFICATIONS		
Name	LC-P127R2P/P1	
Nominal voltage	12V	
Nominal capacity (20 hour rate)	7.2Ah	
Dimensions	Length	151mm
	Width	64.5mm
	Height	100mm
Approx. mass	2.30kg	
Terminal	Faston 187/250	
Capacity (25°C)	20 hour rate	7.2Ah
	10 hour rate	6.6Ah
	3 hour rate	5.8Ah
	1 hour rate	4.9Ah
Impedance	Fully charged battery (25°C)	24mΩ
Temperature dependency of capacity (20 hour rate)	40°C	102%
	25°C	100%
	0°C	85%
	-15°C	65%
Remaining capacity (25°C)	After 3 month	91%
	After 6 month	82%
	After 12 month	64%

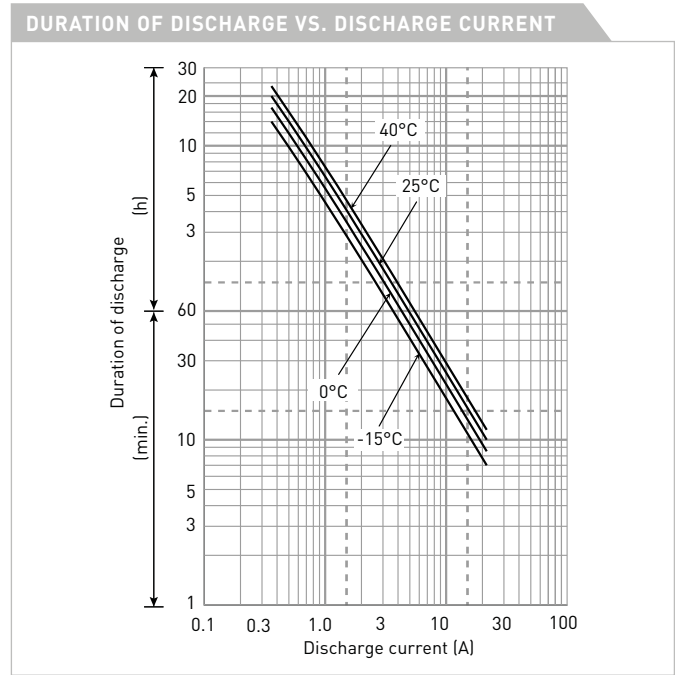

WATT TABLE (25°C)															[Wattage/battery]	
Cut-off	3min.	5min.	10min.	15min.	20min.	30min.	45min.	1h	1.5h	2h	3h	4h	5h	6h	10h	20h
9.6V	430	335	220	167	134	98.4	72.1	56.5	44.6	34.7	24.7	19.2	15.4	12.8	8.39	4.60
9.9V	405	287	187	159	130	96.4	71.6	55.1	43.7	34.4	24.5	19.1	15.3	12.5	8.35	4.59
10.2V	379	273	182	151	126	94.3	68.6	53.6	41.4	32.5	23.5	18.7	14.6	12.2	8.00	4.43
10.5V	343	248	174	144	120	90.8	66.8	52.4	39.8	31.5	23.0	18.3	14.5	12.1	7.96	4.42
10.8V	308	223	164	138	115	87.2	62.6	48.4	37.2	28.1	21.4	16.9	13.3	11.2	7.41	4.13

AMPERE TABLE (25°C)															[Ampere/battery]	
Cut-off	3min.	5min.	10min.	15min.	20min.	30min.	45min.	1h	1.5h	2h	3h	4h	5h	6h	10h	20h
9.6V	38.9	30.6	19.9	14.8	12.3	9.10	6.40	5.10	3.50	2.70	2.00	1.53	1.26	1.02	0.670	0.363
9.9V	36.1	28.7	19.5	14.7	12.1	9.00	6.36	5.05	3.43	2.68	1.99	1.52	1.25	1.01	0.667	0.362
10.2V	34.2	26.9	19.0	14.4	11.9	8.90	6.30	5.00	3.36	2.61	1.97	1.51	1.24	1.00	0.660	0.361
10.5V	31.4	24.1	17.6	13.4	11.3	8.70	6.20	4.90	3.29	2.52	1.94	1.50	1.23	0.988	0.657	0.360
10.8V	29.0	22.3	15.7	12.5	11.0	8.40	6.10	4.80	3.20	2.40	1.90	1.48	1.20	0.972	0.650	0.358

All mentioned values are average values

LC-P127R2P

CHARGING METHOD (25°C)

Trickle use Control voltage: 13.6V - 13.8V
Initial current: 1.08A or smaller

CUT-OFF VOLTAGE

Discharge current	0.36A - 1.44A	1.44A - 3.6A	3.6A - 7.2A	7.2A - 14.4A	14.4A - 21.6A
Cut-off voltage	10.5V	10.2V	9.9V	9.3V	8.7V

INFLUENCE OF TEMPERATURE ON TRICKLE LIFE

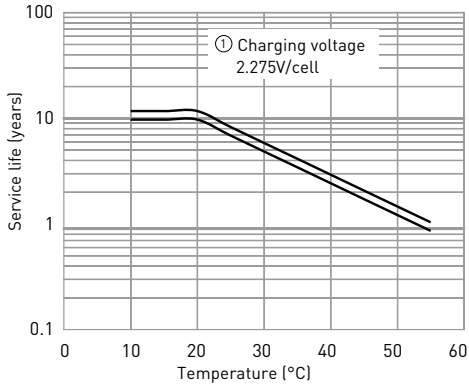

RESIDUAL CAPACITY VS. STORAGE PERIOD

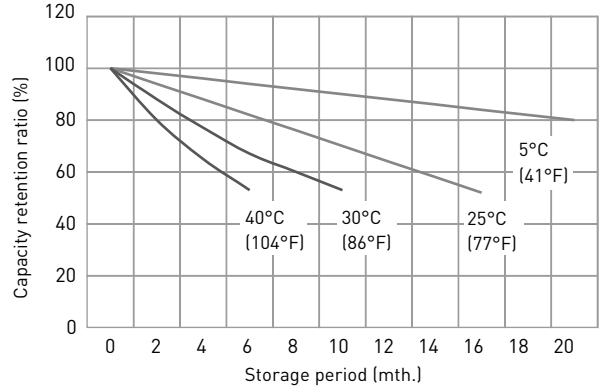

CONSTANT-VOLTAGE CONSTANT-CURRENT CHARGE CHARACTERISTICS FOR TRICKLE USE

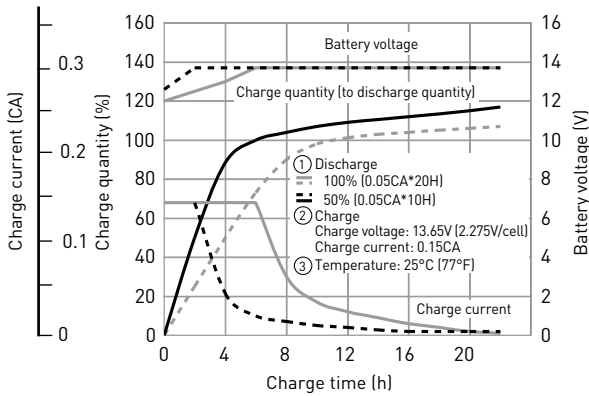

DISCHARGE CAPACITY BY TEMPERATURE AND BY DISCHARGE CURRENT

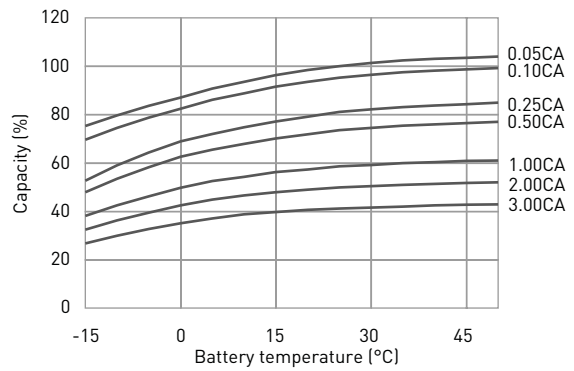

DISCHARGE CHARACTERISTICS

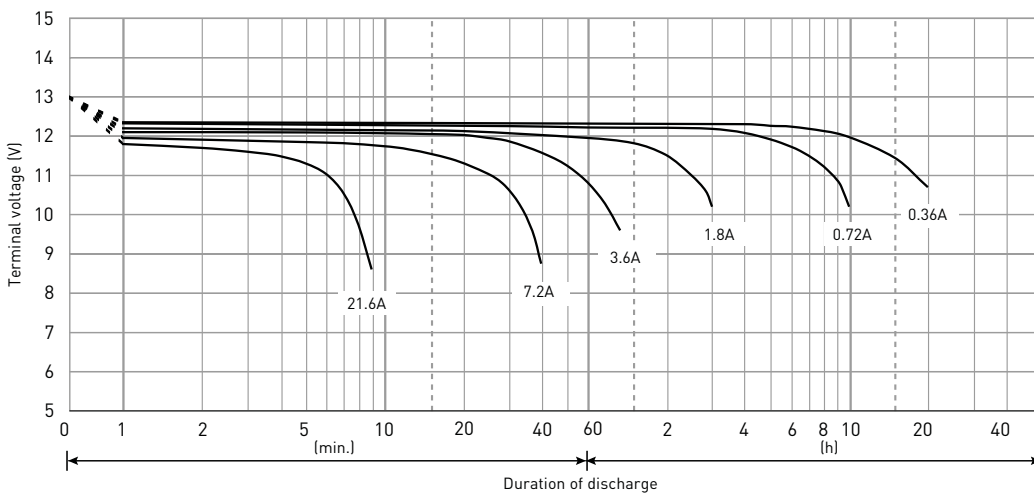

The data in this document are for descriptive purposes only and are not intended to make or imply any guarantee or warranty. Regarding handling and safety please consult our VRLA technical handbook chapter 1.

LC-PA1212P

DIMENSIONS (MM)



FOR STANDBY POWER SUPPLIES.
EXPECTED TRICKLE DESIGN LIFE: 10 - 12 YEARS AT 20°C
ACCORDING TO EUROBAT.

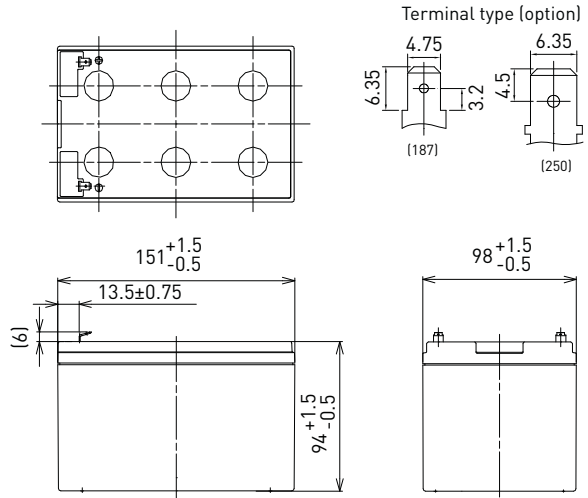

Contents indicated (including the recycle marking, etc.) are subject to change without notice.

Battery case resin: flame retardant (UL94 V-0)

SPECIFICATIONS		LC-PA1212P/P1
Name		LC-PA1212P/P1
Nominal voltage		12V
Nominal capacity (20 hour rate)		12Ah
Dimensions	Length	151mm
	Width	98mm
	Height	100mm
Approx. mass		3.65kg
Terminal		Faston 187/250
Capacity (25°C)	20 hour rate	12.0Ah
	10 hour rate	11.0Ah
	3 hour rate	9.3Ah
	1 hour rate	8.5Ah
Impedance	Fully charged battery (25°C)	18mΩ
	40°C	102%
Temperature dependency of capacity (20 hour rate)	25°C	100%
	0°C	85%
	-15°C	65%
Remaining capacity (25°C)	After 3 month	91%
	After 6 month	82%
	After 12 month	64%

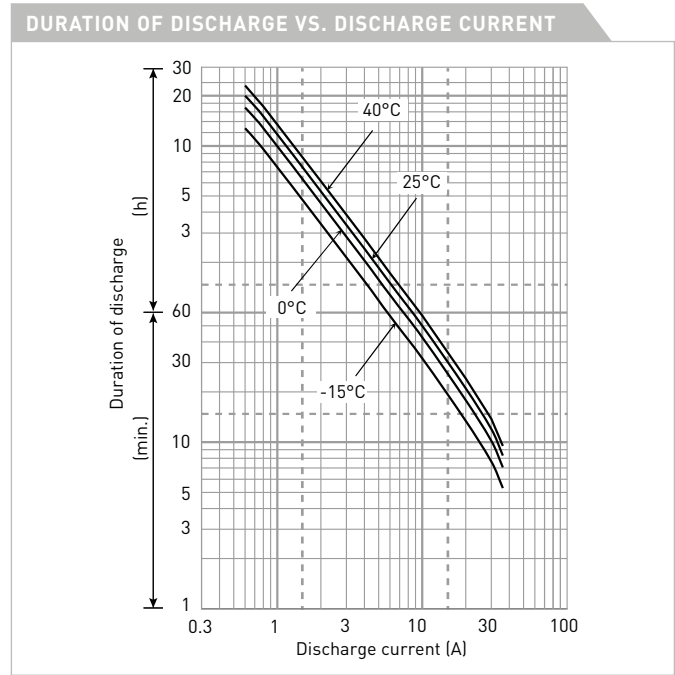

WATT TABLE (25°C)															[Wattage/battery]	
Cut-off	3min.	5min.	10min.	15min.	20min.	30min.	45min.	1h	1.5h	2h	3h	4h	5h	6h	10h	20h
9.6V	679	559	384	298	247	183	137	105	70.3	54.5	38.1	28.8	24.1	21.7	13.3	7.22
9.9V	649	537	373	288	241	177	135	104	69.9	54.2	37.8	28.8	24.1	21.7	13.3	7.22
10.2V	607	506	363	282	235	177	134	102	69.1	53.9	37.5	28.8	24.0	21.6	13.2	7.21
10.5V	556	475	343	271	231	172	133	100	68.5	53.3	36.9	28.7	24.0	21.6	13.2	7.20
10.8V	495	434	321	261	225	166	123	98	66.1	52.1	36.3	28.4	23.8	21.5	13.1	7.18

AMPERE TABLE (25°C)															[Ampere/battery]	
Cut-off	3min.	5min.	10min.	15min.	20min.	30min.	45min.	1h	1.5h	2h	3h	4h	5h	6h	10h	20h
9.6V	61.1	50.1	34.3	25.9	21.3	15.6	11.7	8.90	5.95	4.60	3.20	2.41	2.01	1.81	1.11	0.602
9.9V	58.4	48.2	33.3	25.0	20.8	15.1	11.5	8.80	5.92	4.58	3.18	2.41	2.01	1.81	1.11	0.602
10.2V	54.6	45.4	32.4	24.5	20.3	15.1	11.4	8.70	5.85	4.55	3.15	2.41	2.00	1.80	1.10	0.601
10.5V	50.0	42.6	30.6	23.6	19.9	14.7	11.3	8.50	5.80	4.50	3.10	2.40	2.00	1.80	1.10	0.600
10.8V	44.5	38.9	28.7	22.7	19.4	14.2	10.5	8.30	5.60	4.40	3.05	2.38	1.99	1.79	1.09	0.598

All mentioned values are average values

LC-PA1212P

CHARGING METHOD (25°C)

Trickle use	Control voltage: 13.6V - 13.8V Initial current: 1.8A or smaller
--------------------	--

CUT-OFF VOLTAGE

Discharge current	0.6A - 2.4A	2.4A - 6A	6A - 12A	12A - 24A	24A - 36A
Cut-off voltage	10.5V	10.2V	9.9V	9.3V	8.7V

INFLUENCE OF TEMPERATURE ON TRICKLE LIFE

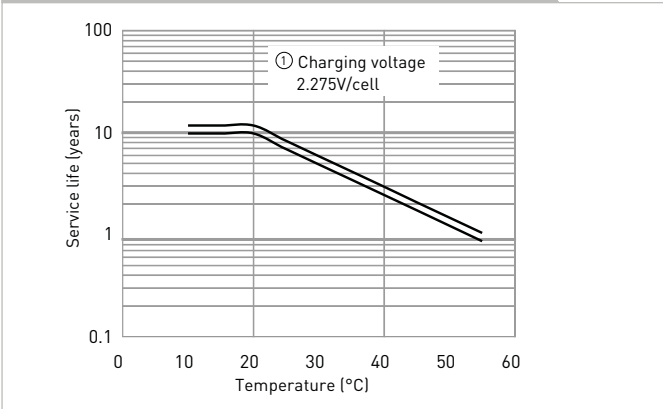

RESIDUAL CAPACITY VS. STORAGE PERIOD

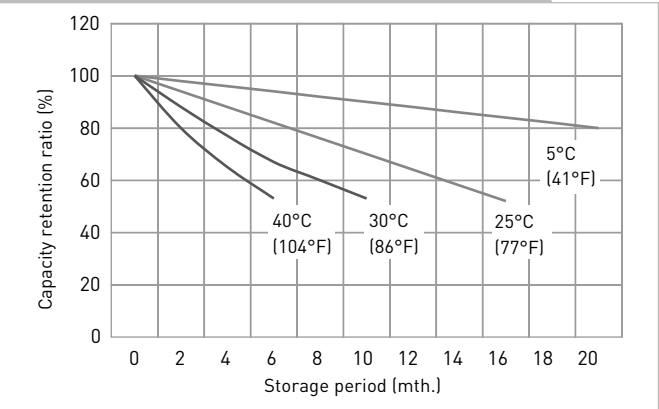

CONSTANT-VOLTAGE CONSTANT-CURRENT CHARGE CHARACTERISTICS FOR TRICKLE USE

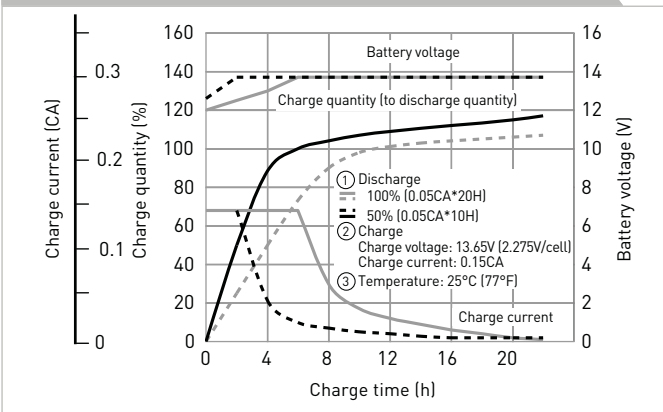

DISCHARGE CAPACITY BY TEMPERATURE AND BY DISCHARGE CURRENT

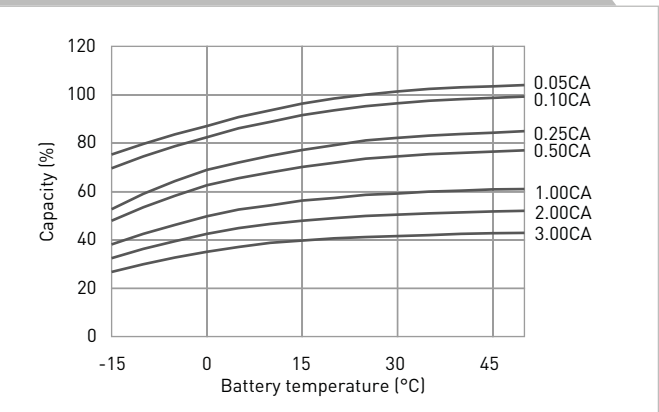

DISCHARGE CHARACTERISTICS

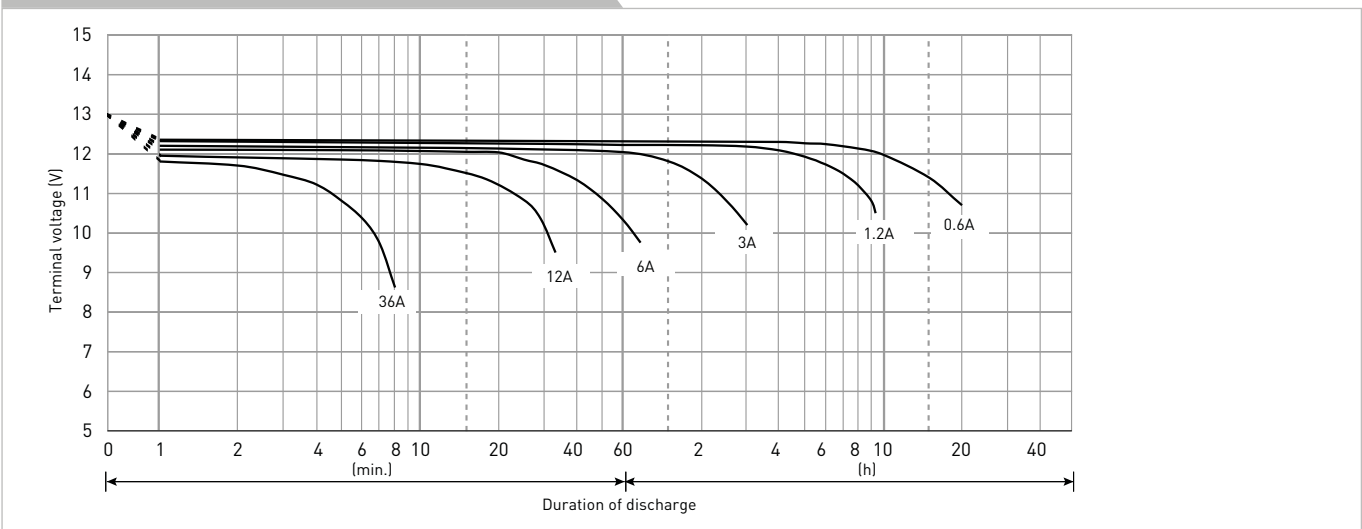

The data in this document are for descriptive purposes only and are not intended to make or imply any guarantee or warranty. Regarding handling and safety please consult our VRLA technical handbook chapter 1.

LC-PA1216P

DIMENSIONS (MM)



FOR STANDBY POWER SUPPLIES.
 EXPECTED TRICKLE DESIGN LIFE: 10 – 12 YEARS AT 20°C
 ACCORDING TO EUROBAT.

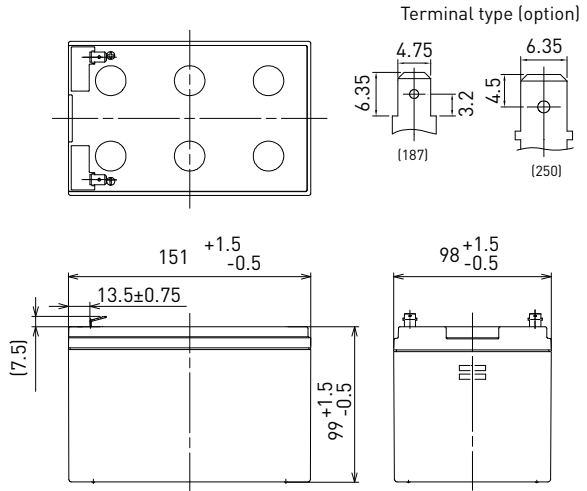

Contents indicated (including the recycle marking, etc.) are subject to change without notice.

Battery case resin: flame retardant (UL94 V-0)

SPECIFICATIONS		
Name	LC-PA1216P/P1	
Nominal voltage	12V	
Nominal capacity (20 hour rate)	16Ah	
Dimensions	Length	151mm
	Width	98mm
	Height	105mm
Approx. mass	4.10kg	
Terminal	Faston 187/250	
Capacity (25°C)	20 hour rate	16Ah
	10 hour rate	15Ah
	3 hour rate	13Ah
	1 hour rate	11Ah
Impedance	Fully charged battery (25°C)	13mΩ
Temperature dependency of capacity (20 hour rate)	40°C	102%
	25°C	100%
	0°C	85%
	-15°C	65%
Remaining capacity (25°C)	After 3 month	91%
	After 6 month	82%
	After 12 month	64%

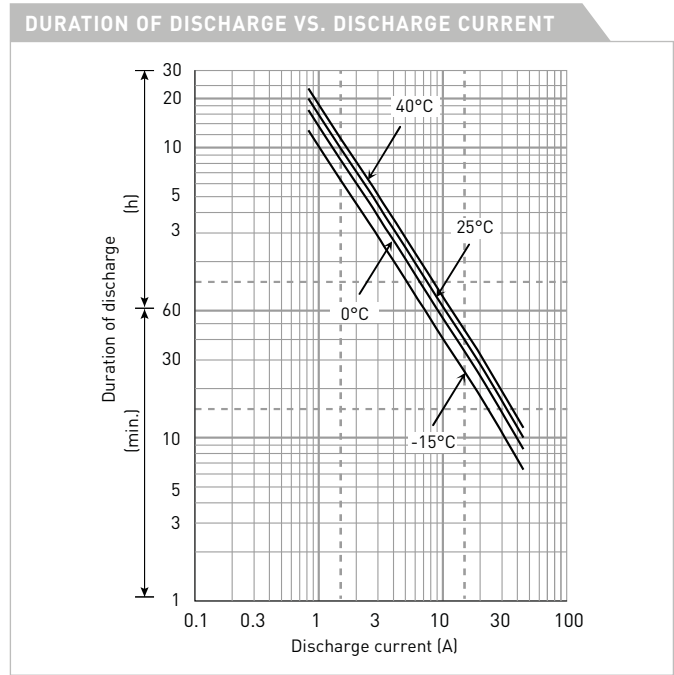

WATT TABLE (25°C)																(Wattage/battery)
Cut-off	3min.	5min.	10min.	15min.	20min.	30min.	45min.	1h	1.5h	2h	3h	4h	5h	6h	10h	20h
9.6V	850	716	445	339	277	201	151	124	91.9	73.1	52.8	41.2	34.5	29.7	19.0	10.2
9.9V	815	685	427	323	268	197	150	121	90.1	72.5	52.6	40.9	34.2	29.1	18.9	10.2
10.2V	760	640	417	307	260	193	144	117	85.4	68.5	50.3	40.1	32.8	28.4	18.1	9.81
10.5V	680	580	398	293	249	185	140	115	82.0	66.4	49.3	39.3	32.7	28.1	18.0	9.78
10.8V	590	520	350	281	238	178	131	106	76.5	59.2	45.7	36.3	29.9	26.0	16.8	9.16

AMPERE TABLE (25°C)																(Ampere/battery)
Cut-off	3min.	5min.	10min.	15min.	20min.	30min.	45min.	1h	1.5h	2h	3h	4h	5h	6h	10h	20h
9.6V	82.9	66.3	44.7	32.7	26.3	19.1	13.8	10.9	7.98	6.21	4.33	3.28	2.82	2.34	1.54	0.800
9.9V	76.5	62.2	43.8	32.5	25.9	18.9	13.7	10.8	7.82	6.17	4.31	3.26	2.79	2.33	1.53	0.800
10.2V	70.3	58.3	42.7	31.8	25.4	18.7	13.6	10.7	7.66	6.01	4.26	3.24	2.77	2.32	1.52	0.800
10.5V	62.3	52.2	39.5	29.6	24.2	18.3	13.4	10.5	7.50	5.80	4.20	3.22	2.75	2.31	1.51	0.800
10.8V	52.4	45.8	35.3	27.6	23.5	17.6	13.2	10.3	7.29	5.52	4.11	3.18	2.68	2.28	1.49	0.800

All mentioned values are average values

LC-PA1216P

CHARGING METHOD (25°C)

Trickle use Control voltage: 13.6V - 13.8V
Initial current: 2.40A or smaller

CUT-OFF VOLTAGE

Discharge current	0.800A - 3.20A	3.20A - 8.00A	8.00A - 16.0A	16.0A - 32.0A	32.0A - 48.0A
Cut-off voltage	10.5V	10.2V	9.9V	9.3V	8.7V

INFLUENCE OF TEMPERATURE ON TRICKLE LIFE

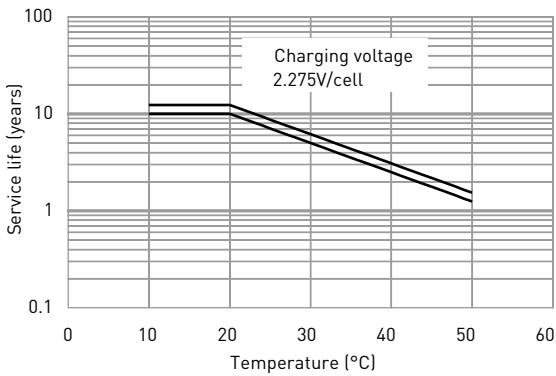

RESIDUAL CAPACITY TEST RESULT

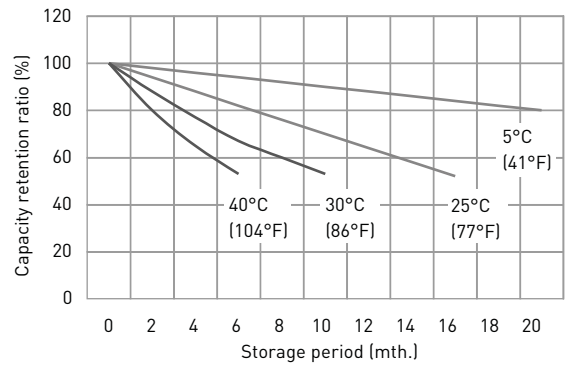

CONSTANT-VOLTAGE CONSTANT-CURRENT CHARGE CHARACTERISTICS FOR TRICKLE USE

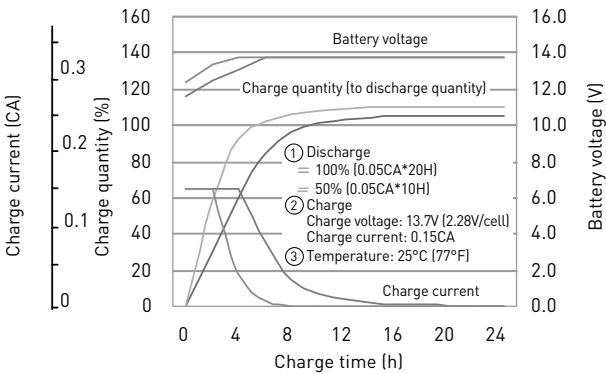

DISCHARGE CAPACITY BY TEMPERATURE AND BY DISCHARGE CURRENT

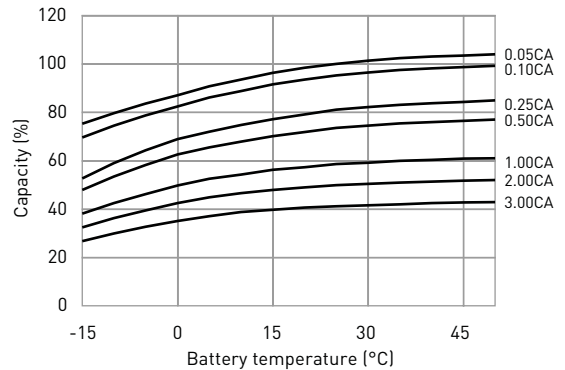

DISCHARGE CHARACTERISTICS

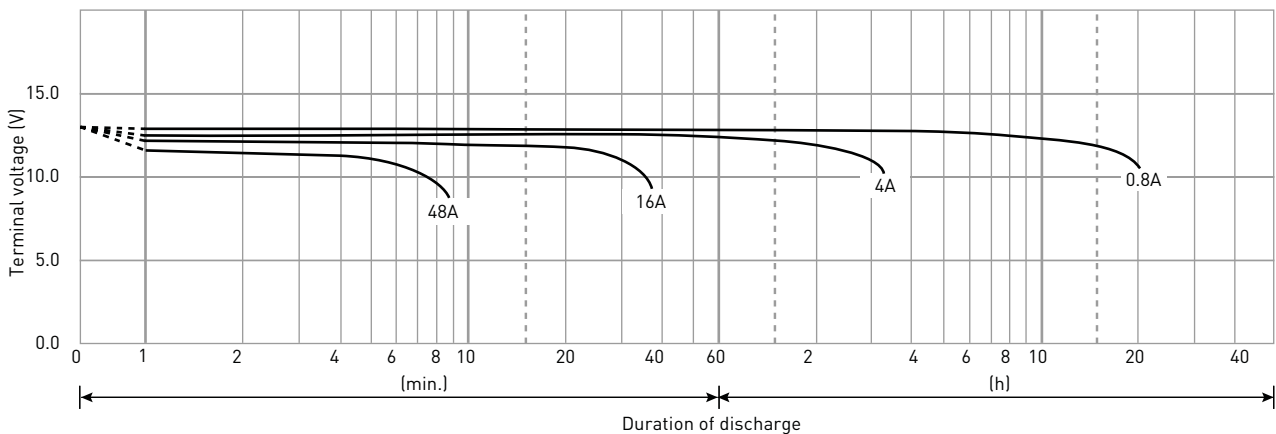

The data in this document are for descriptive purposes only and are not intended to make or imply any guarantee or warranty. Regarding handling and safety please consult our VRLA technical handbook chapter 1.

LC-X1265P*1

FOR STANDBY POWER SUPPLIES.
EXPECTED TRICKLE DESIGN LIFE: 10 - 12 YEARS
AT 20°C ACCORDING TO EUROBAT.



G199090

DIMENSIONS (MM)

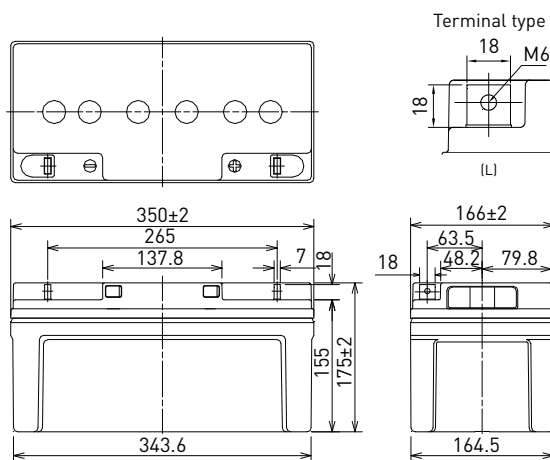

Contents indicated (including the recycle marking, etc.) are subject to change without notice.

Battery case resin: standard (UL94 HB)

SPECIFICATIONS		
Name	LC-X1265PG*1	
Nominal voltage	12V	
Nominal capacity (20 hour rate)	65Ah	
Dimensions	Length	350mm
	Width	166mm
	Height	175mm
Approx. mass	23.5kg	
Terminal	M6 bolt/nut	
Capacity (25°C)	20 hour rate	65Ah
	10 hour rate	60Ah
	3 hour rate	49Ah
	1 hour rate	40Ah
Impedance	Fully charged battery (25°C)	7mΩ
	40°C	102%
Temperature dependency of capacity (20 hour rate)	25°C	100%
	0°C	85%
	-15°C	65%
Remaining capacity (25°C)	After 3 month	91%
	After 6 month	82%
	After 12 month	64%

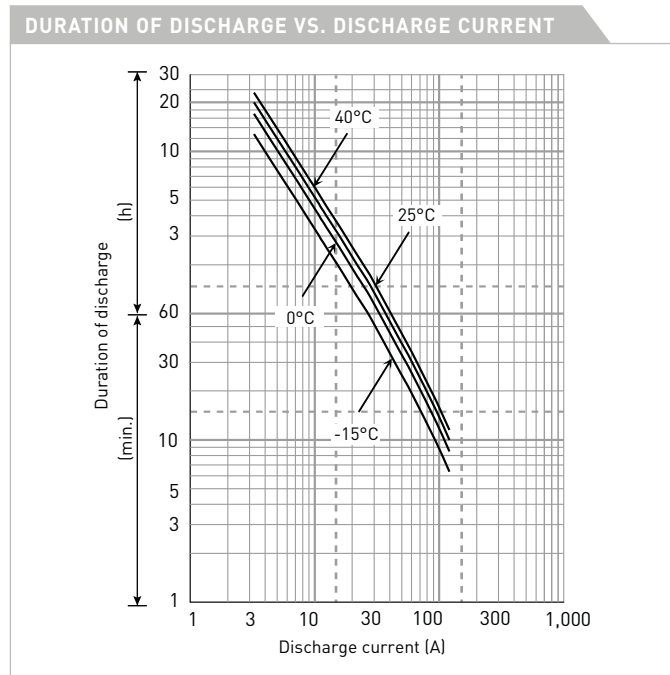

WATT TABLE (25°C)															[Wattage/battery]	
Cut-off	5min.	10min.	15min.	20min.	30min.	45min.	1h	1.5h	2h	3h	4h	5h	6h	10h	20h	
9.6V	1,884	1,439	1,127	956	742	533	501	321	290	201	158	131	115	70.80	39.00	
9.9V	1,851	1,422	1,116	951	734	520	494	313	289	198	157	127	114	70.40	39.00	
10.2V	1,735	1,386	1,093	935	725	515	484	307	281	196	156	126	113	70.10	38.90	
10.5V	1,554	1,284	1,017	888	709	507	474	300	272	193	154	125	112	69.70	38.80	
10.8V	1,374	1,145	949	865	685	499	465	292	259	189	152	122	111	69.00	38.60	

AMPERE TABLE (25°C)															[Ampere/battery]	
Cut-off	5min.	10min.	15min.	20min.	30min.	45min.	1h	1.5h	2h	3h	4h	5h	6h	10h	20h	
9.6V	195	129	98.0	82.4	63.4	45.4	42.2	27.2	24.5	16.9	13.2	11.1	9.60	6.05	3.27	
9.9V	193	127	97.0	82.0	62.7	44.3	41.6	26.5	24.4	16.6	13.1	10.8	9.56	6.02	3.27	
10.2V	183	124	95.0	80.6	62.0	43.9	40.8	26.0	23.8	16.4	13.0	10.7	9.52	5.99	3.26	
10.5V	166	115	88.4	76.6	60.6	43.2	40.0	25.4	22.9	16.2	12.9	10.6	9.41	5.96	3.25	
10.8V	150	102	82.5	74.5	58.5	42.5	39.2	24.7	21.9	15.8	12.8	10.3	9.26	5.90	3.23	

All mentioned values are average values

LC-X1265P*1

CHARGING METHOD (25°C)

Trickle use Control voltage: 13.6V - 13.8V
Initial current: 9.75A or smaller

CUT-OFF VOLTAGE

Discharge current	3.25A - 13.0A	13.0A - 32.5A	32.5A - 65.0A	65.0A - 130A	130A - 195A
Cut-off voltage	10.5V	10.2V	9.9V	9.3V	8.7V

INFLUENCE OF TEMPERATURE ON TRICKLE LIFE

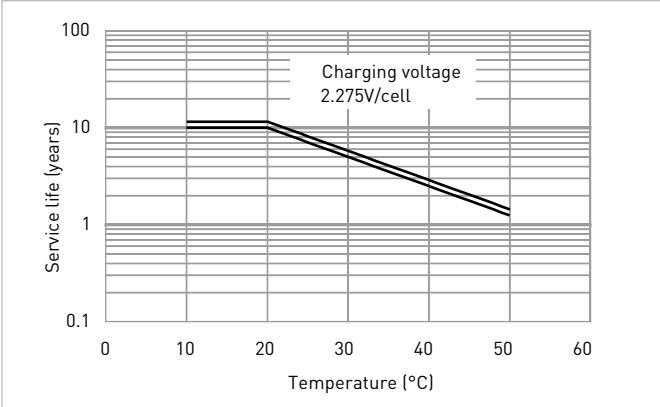

RESIDUAL CAPACITY TEST RESULT

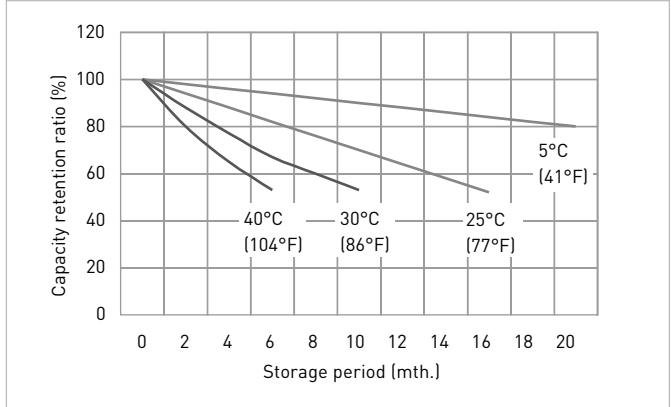

CONSTANT-VOLTAGE CONSTANT-CURRENT CHARGE CHARACTERISTICS FOR TRICKLE USE

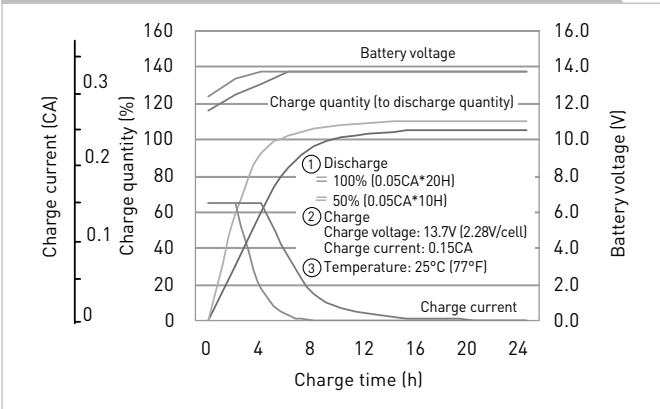

DISCHARGE CAPACITY BY TEMPERATURE AND BY DISCHARGE CURRENT

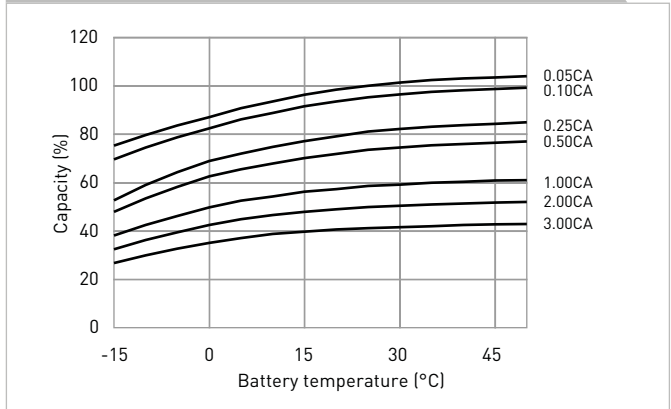

DISCHARGE CHARACTERISTICS

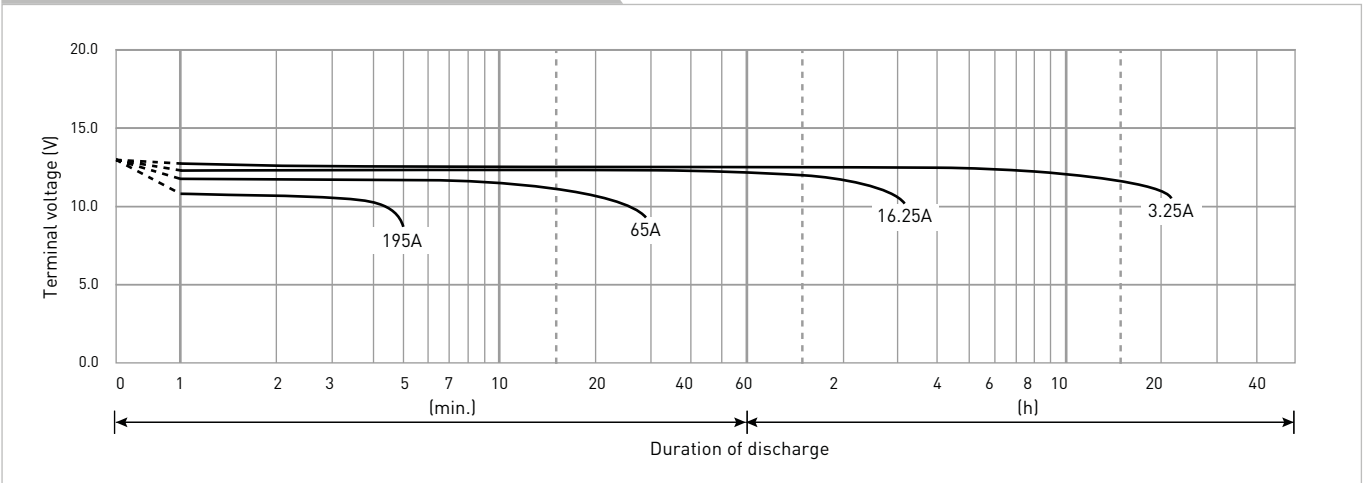

The data in this document are for descriptive purposes only and are not intended to make or imply any guarantee or warranty. Regarding handling and safety please consult our VRLA technical handbook chapter 1.

*1 This battery is also available with a flame retardant battery case resin (UL94 V-0): LC-P1265PG.

LC-XB12100P*1

DIMENSIONS (MM)



FOR STANDBY POWER SUPPLIES.
EXPECTED TRICKLE DESIGN LIFE: 10 - 12 YEARS AT 20°C
ACCORDING TO EUROBAT.

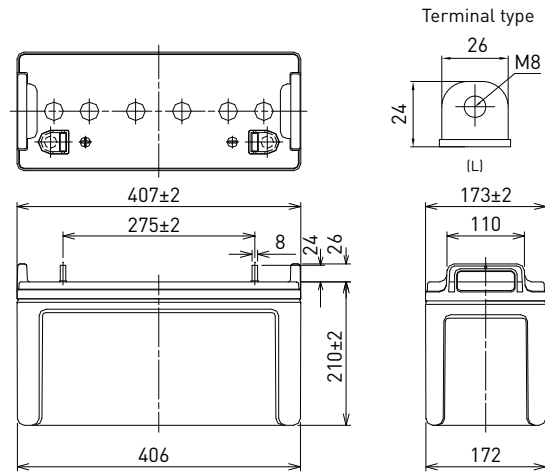

Contents indicated (including the recycle marking, etc.) are subject to change without notice.

Battery case resin: standard (UL94 HB)

SPECIFICATIONS		
Name	LC-XB12100P*1	
Nominal voltage	12V	
Nominal capacity (20 hour rate)	100Ah	
Dimensions	Length	407mm
	Width	173mm
	Height	236mm
Approx. mass	36.5kg	
Terminal	M8 bolt/nut	
Capacity (25°C)	20 hour rate	100Ah
	10 hour rate	98Ah
	3 hour rate	87Ah
	1 hour rate	65Ah
Impedance	Fully charged battery (25°C)	5.0mΩ
Temperature dependency of capacity (20 hour rate)	40°C	102%
	25°C	100%
	0°C	85%
	-15°C	65%
Remaining capacity (25°C)	After 3 month	91%
	After 6 month	82%
	After 12 month	64%

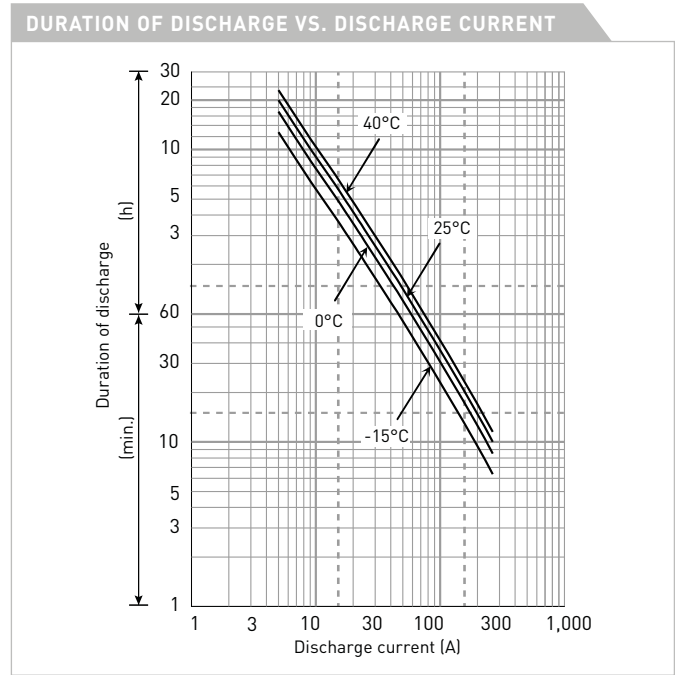

WATT TABLE (25°C)																(Wattage/battery)
Cut-off	5min.	10min.	15min.	20min.	30min.	45min.	1h	1.5h	2h	3h	4h	5h	6h	10h	20h	
9.6V	3,504	2,698	2,275	1,776	1,258	904	880	502	411	292	221	188	150	95.0	48.1	
9.9V	3,266	2,639	1,973	1,683	1,239	878	795	493	408	287	219	185	149	95.0	48.1	
10.2V	2,890	2,534	1,920	1,651	1,229	850	779	489	403	285	217	181	148	94.1	48.1	
10.5V	2,498	2,379	1,849	1,601	1,200	738	762	483	398	278	214	180	147	94.1	48.0	
10.8V	2,375	2,178	1,756	1,544	1,199	734	758	435	378	272	212	179	144	93.1	47.3	

AMPERE TABLE (25°C)																(Ampere/battery)
Cut-off	5min.	10min.	15min.	20min.	30min.	45min.	1h	1.5h	2h	3h	4h	5h	6h	10h	20h	
9.6V	365	281	237	185	131	94.2	87.3	52.3	42.8	30.4	23.0	19.5	15.7	9.90	5.01	
9.9V	340	275	206	175	129	91.5	78.9	51.3	42.5	29.9	22.8	19.2	15.6	9.90	5.01	
10.2V	301	264	200	172	128	88.5	75.5	50.9	42.0	29.7	22.6	18.9	15.5	9.80	5.01	
10.5V	260	248	193	167	125	76.9	75.0	50.3	41.5	29.0	22.3	18.8	15.3	9.80	5.00	
10.8V	247	227	183	161	125	76.4	74.9	45.3	39.4	28.3	22.0	18.7	15.0	9.70	4.92	

All mentioned values are average values

LC-XB12100P*1

CHARGING METHOD (25°C)

Trickle use Control voltage: 13.6V - 13.8V
Initial current: 15.0A or smaller

CUT-OFF VOLTAGE

Discharge current	5.00A - 20.0A	20.0A - 50.0A	50.0A - 100A	100A - 200A	200A - 300A
Cut-off voltage	10.5V	10.2V	9.9V	9.3V	8.7V

INFLUENCE OF TEMPERATURE ON TRICKLE LIFE

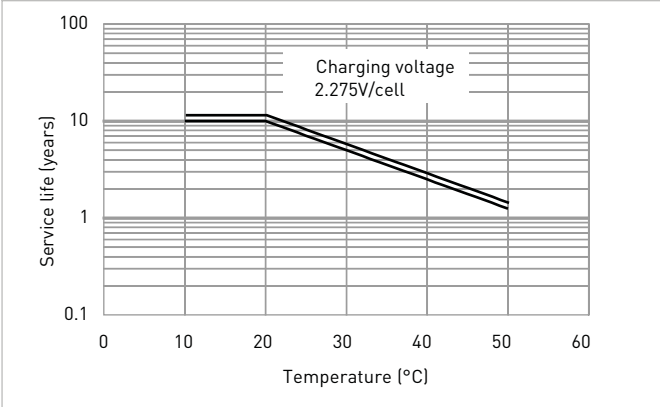

RESIDUAL CAPACITY TEST RESULT

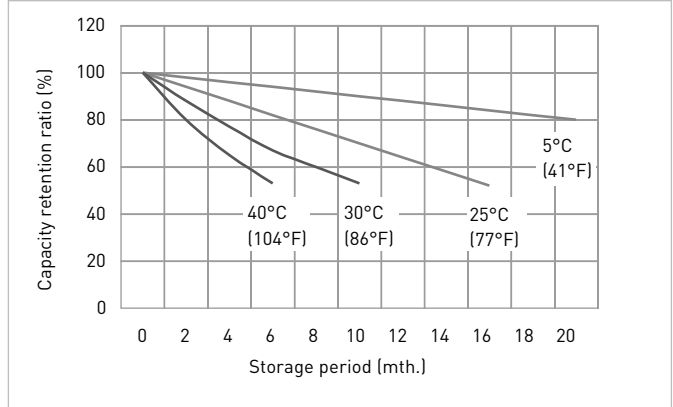

CONSTANT-VOLTAGE CONSTANT-CURRENT CHARGE CHARACTERISTICS FOR TRICKLE USE

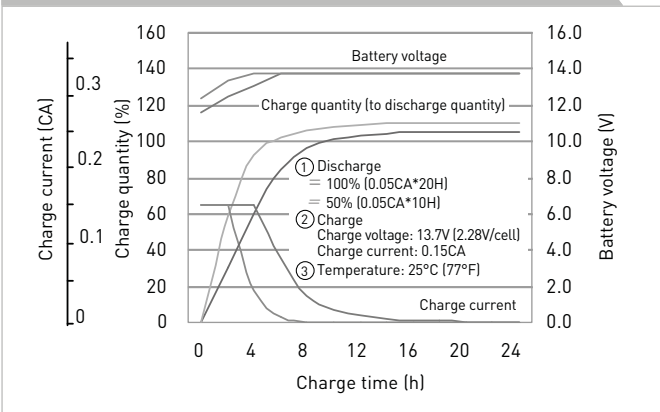

DISCHARGE CAPACITY BY TEMPERATURE AND BY DISCHARGE CURRENT

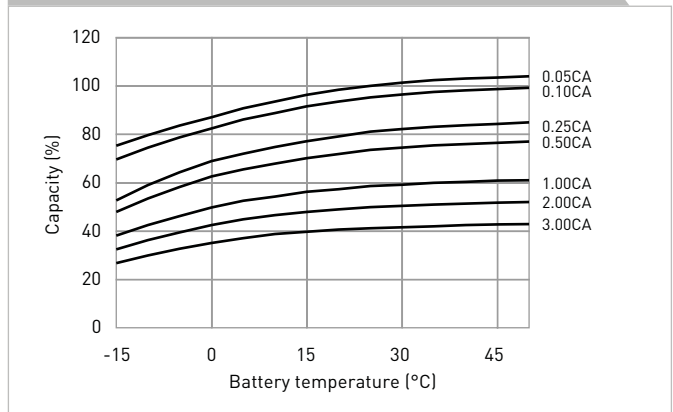

DISCHARGE CHARACTERISTICS

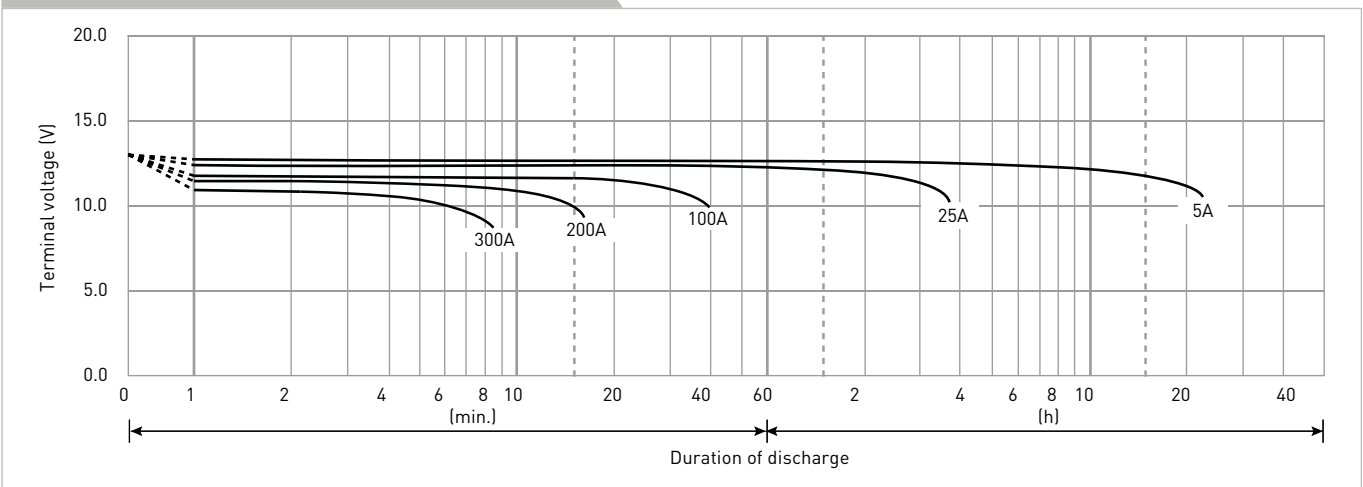

The data in this document are for descriptive purposes only and are not intended to make or imply any guarantee or warranty. Regarding handling and safety please consult our VRLA technical handbook chapter 1.

*1 This battery is also available with a flame retardant battery case resin (UL94 V-0): LC-PB12100P.

LC-XD1217P*1

FOR STANDBY POWER SUPPLIES.
 EXPECTED TRICKLE DESIGN LIFE: 10 - 12 YEARS
 AT 20°C ACCORDING TO EUROBAT.



G104101

DIMENSIONS (MM)

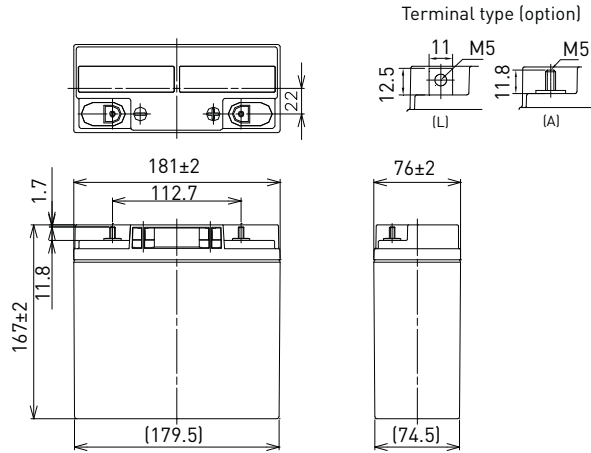

Contents indicated (including the recycle marking, etc.) are subject to change without notice.

Battery case resin: standard (UL94 HB)

SPECIFICATIONS		LC-XD1217PG/AG*1
Name		LC-XD1217PG/AG*1
Nominal voltage		12V
Nominal capacity (20 hour rate)		17Ah
Dimensions	Length	181mm
	Width	76mm
	Height	167mm
Approx. mass		5.900kg
Terminal		M5 bolt/nut & threaded post
Capacity (25°C)	20 hour rate	17Ah
	10 hour rate	16Ah
	3 hour rate	14Ah
	1 hour rate	12Ah
Impedance		Fully charged battery (25°C) 12mΩ
Temperature dependency of capacity (20 hour rate)	40°C	102%
	25°C	100%
	0°C	85%
	-15°C	65%
Remaining capacity (25°C)	After 3 month	91%
	After 6 month	82%
	After 12 month	64%

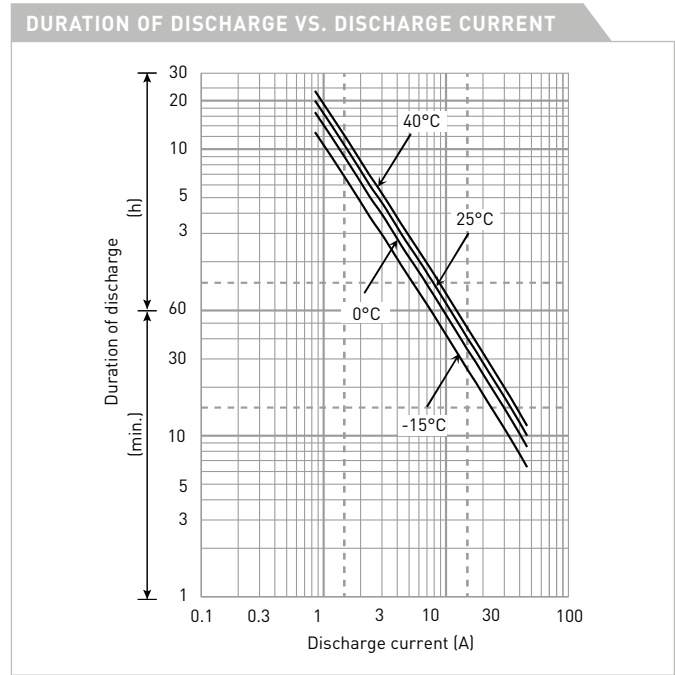

WATT TABLE (25°C)																(Wattage/battery)
Cut-off	3min.	5min.	10min.	15min.	20min.	30min.	45min.	1h	1.5h	2h	3h	4h	5h	6h	10h	20h
9.6V	1,021	806	526	402	337	251	177	142	97.6	75.5	56.2	43.2	35.6	28.6	19.0	10.3
9.9V	948	756	516	399	331	249	176	140	95.6	74.9	55.9	42.9	35.4	28.5	18.9	10.3
10.2V	874	708	502	391	326	246	175	139	93.7	73.0	55.4	42.6	35.1	28.3	18.7	10.2
10.5V	777	634	465	364	309	240	172	136	91.7	70.4	54.5	42.3	34.8	28.0	18.6	10.2
10.8V	656	561	415	339	301	232	169	134	89.2	67.1	53.4	41.8	33.9	27.5	18.4	10.1

AMPERE TABLE (25°C)																(Ampere/battery)
Cut-off	3min.	5min.	10min.	15min.	20min.	30min.	45min.	1h	1.5h	2h	3h	4h	5h	6h	10h	20h
9.6V	91.8	72.2	47.0	34.9	29.0	21.5	15.1	12.0	8.26	6.37	4.72	3.61	2.97	2.39	1.58	0.86
9.9V	85.2	67.8	46.0	34.7	28.6	21.2	15.0	11.9	8.10	6.33	4.70	3.59	2.95	2.38	1.57	0.85
10.2V	78.6	63.5	44.9	34.0	28.1	21.0	14.9	11.7	7.93	6.16	4.65	3.57	2.93	2.36	1.56	0.85
10.5V	69.9	56.9	41.6	31.6	26.7	20.5	14.6	11.6	7.77	5.95	4.58	3.54	2.90	2.33	1.55	0.85
10.8V	59.0	50.3	37.1	29.5	26.0	19.8	14.4	11.3	7.56	5.67	4.49	3.49	2.83	2.29	1.53	0.85

All mentioned values are average values

LC-XD1217P*1

CHARGING METHOD (25°C)

Trickle use Control voltage: 13.6V - 13.8V
Initial current: 2.55A or smaller

CUT-OFF VOLTAGE

Discharge current	0.850A - 3.40A	3.40A - 8.50A	8.50A - 17.0A	17.0A - 34.0A	34.0A - 51.0A
Cut-off voltage	10.5V	10.2V	9.9V	9.3V	8.7V

INFLUENCE OF TEMPERATURE ON TRICKLE LIFE

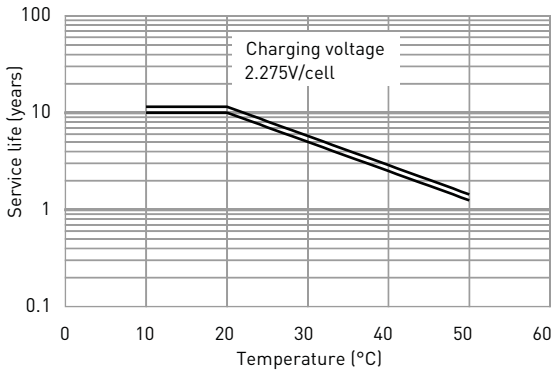

RESIDUAL CAPACITY TEST RESULT

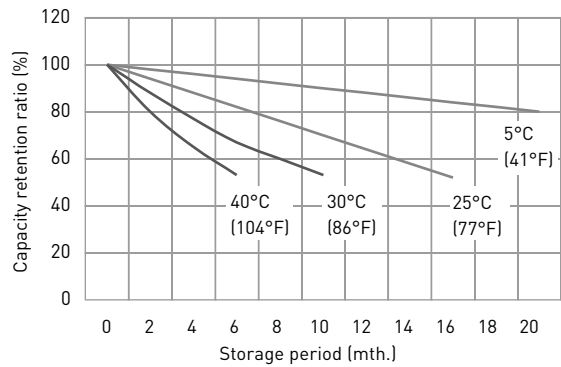

CONSTANT-VOLTAGE CONSTANT-CURRENT CHARGE CHARACTERISTICS FOR TRICKLE USE

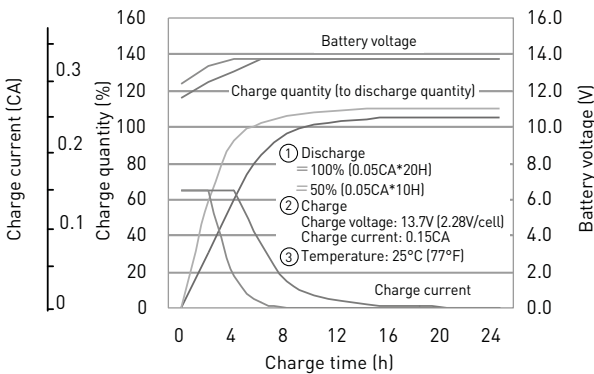

DISCHARGE CAPACITY BY TEMPERATURE AND BY DISCHARGE CURRENT

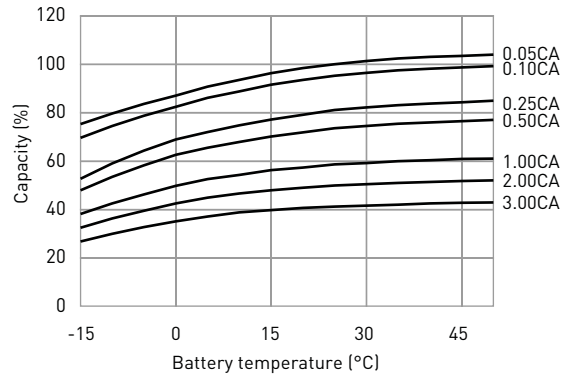

DISCHARGE CHARACTERISTICS

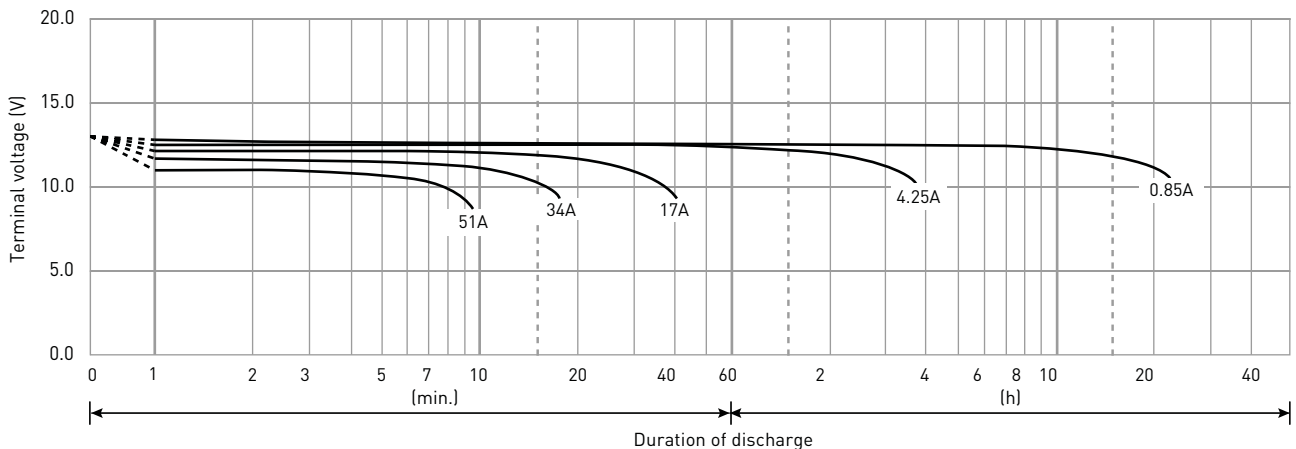

The data in this document are for descriptive purposes only and are not intended to make or imply any guarantee or warranty. Regarding handling and safety please consult our VRLA technical handbook chapter 1.

*1 This battery is also available with a flame retardant battery case resin (UL94 V-0): LC-PD1217PG/APG.