

FEATURES

- Specified over temperature
- Low power consumption (12 μ A)
- Precision monitoring of 2.5 V, 3 V, 3.3 V, and 5 V power supply voltages
- Reset timeout period of 140 ms (minimum)
- Manual reset input
- Output stages
 - Push-pull $\overline{\text{RESET}}$ output (ADM6711)
 - Open-drain $\overline{\text{RESET}}$ output (ADM6713)
- Reset assertion down to 1 V V_{CC}
- Power supply glitch immunity
- 4-lead SC70 package

APPLICATIONS

- Microprocessor systems
- Computers
- Controllers
- Intelligent instruments
- Automotive systems

GENERAL DESCRIPTION

The ADM6711/ADM6713 are reset generator circuits suitable for use in microprocessor-based systems. They provide a reset signal on power-up, power-down, and whenever the supply voltage falls below a preset threshold. In addition, both parts have a debounced manual reset input so that a reset signal can also be initiated with an external switch or logic signal.

With six different reset threshold options available ranging from 2.32 V to 4.63 V, the ADM6711/ADM6713 are suitable for monitoring 2.5 V, 3 V, 3.3 V, and 5 V supplies. A reset timeout of at least 140 ms occurs when V_{CC} rises above the threshold. This gives the supply voltage time to stabilize before the microprocessor starts up.

The ADM6711 has a push-pull output, so no additional external components are needed. The ADM6713 open-drain output requires an external pull-up resistor that can be connected to a voltage higher than V_{CC} , if desired.

FUNCTIONAL BLOCK DIAGRAMS

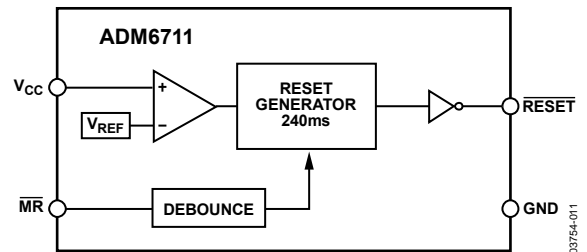

Figure 1.

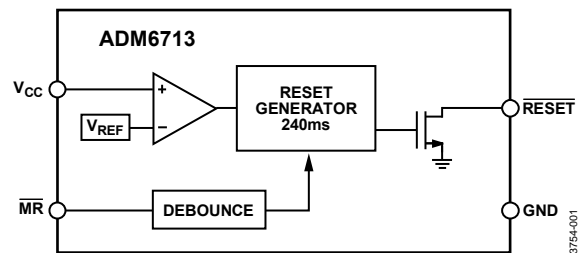

Figure 2.

The parts are highly reliable with accurate voltage references and immunity to fast, negative-going transients on V_{CC} . Low current consumption and space-efficient, 4-lead SC70 packaging make the ADM6711/ADM6713 ideal for use in low power portable applications.



Figure 3. Typical Operating Circuit

Rev. B

Information furnished by Analog Devices is believed to be accurate and reliable. However, no responsibility is assumed by Analog Devices for its use, nor for any infringements of patents or other rights of third parties that may result from its use. Specifications subject to change without notice. No license is granted by implication or otherwise under any patent or patent rights of Analog Devices. Trademarks and registered trademarks are the property of their respective owners.

TABLE OF CONTENTS

Features	1	Typical Performance Characteristics	7
Applications	1	Circuit Description	8
Functional Block Diagrams	1	Manual Reset Input	8
General Description	1	Power Supply Glitch Immunity	8
Revision History	2	ADM6713 $\overline{\text{RESET}}$ Output Logic Levels	8
Specifications	3	Ensuring a Valid $\overline{\text{RESET}}$ Output Down To $V_{CC} = 0\text{ V}$	8
Absolute Maximum Ratings	5	Outline Dimensions	9
ESD Caution	5	Ordering Guide	9
Pin Configuration and Function Descriptions	6		

REVISION HISTORY

9/11—Rev. A to Rev. B

Changes to Input Threshold Parameter, Table 1	4
Updated Outline Dimensions	9

12/06—Rev. 0 to Rev. A

Updated Format	Universal
Changes to Specifications Table	3
Changes to Figure 10	8
Changes to Ordering Guide	9

8/03—Revision 0: Initial Version

SPECIFICATIONS

V_{CC} = full operating range; $T_A = T_{MIN}$ to T_{MAX} ; V_{CC} typ = 5 V for L/M models, 3.3 V for T/S models, 3 V for R models, and 2.5 V for Z models, unless otherwise noted.

Table 1.

Parameter	Min	Typ	Max	Unit	Test Conditions/Comments
SUPPLY					
V_{CC} Operating Voltage Range	1.0		5.5	V	$T_A = 0^\circ\text{C}$ to 70°C
	1.2		5.5	V	$T_A = -40^\circ\text{C}$ to $+125^\circ\text{C}$
Supply Current		16	35	μA	$V_{CC} < 5.5\text{ V}$, ADM671_L/M, $T_A = -40^\circ\text{C}$ to $+85^\circ\text{C}$
		12	30	μA	$V_{CC} < 3.6\text{ V}$, ADM671_R/S/T/Z, $T_A = -40^\circ\text{C}$ to $+85^\circ\text{C}$
			60	μA	$V_{CC} < 5.5\text{ V}$, ADM671_L/M, $T_A = 85^\circ\text{C}$ to 125°C
			60	μA	$V_{CC} < 3.6\text{ V}$, ADM671_R/S/T/Z, $T_A = 85^\circ\text{C}$ to 125°C
RESET VOLTAGE THRESHOLD					
ADM671_L	4.56	4.63	4.70	V	$T_A = 25^\circ\text{C}$
	4.50		4.75	V	$T_A = -40^\circ\text{C}$ to $+85^\circ\text{C}$
	4.44		4.82	V	$T_A = 85^\circ\text{C}$ to 125°C
ADM671_M	4.31	4.38	4.45	V	$T_A = 25^\circ\text{C}$
	4.25		4.50	V	$T_A = -40^\circ\text{C}$ to $+85^\circ\text{C}$
	4.20		4.56	V	$T_A = 85^\circ\text{C}$ to 125°C
ADM671_T	3.04	3.08	3.11	V	$T_A = 25^\circ\text{C}$
	3.00		3.15	V	$T_A = -40^\circ\text{C}$ to $+85^\circ\text{C}$
	2.95		3.21	V	$T_A = 85^\circ\text{C}$ to 125°C
ADM671_S	2.89	2.93	2.96	V	$T_A = 25^\circ\text{C}$
	2.85		3.00	V	$T_A = -40^\circ\text{C}$ to $+85^\circ\text{C}$
	2.81		3.05	V	$T_A = 85^\circ\text{C}$ to 125°C
ADM671_R	2.59	2.63	2.66	V	$T_A = 25^\circ\text{C}$
	2.55		2.70	V	$T_A = -40^\circ\text{C}$ to $+85^\circ\text{C}$
	2.52		2.74	V	$T_A = 85^\circ\text{C}$ to 125°C
ADM671_Z	2.28	2.32	2.35	V	$T_A = 25^\circ\text{C}$
	2.25		2.38	V	$T_A = -40^\circ\text{C}$ to $+85^\circ\text{C}$
	2.22		2.42	V	$T_A = 85^\circ\text{C}$ to 125°C
RESET THRESHOLD TEMPERATURE COEFFICIENT		30		ppm/ $^\circ\text{C}$	
V_{CC} to $\overline{\text{RESET}}$ DELAY		20		μs	$V_{CC} = V_{TH}$ to $(V_{TH} - 100\text{ mV})$
$\overline{\text{RESET}}$ ACTIVE TIMEOUT PERIOD					
	140	240	460	ms	$T_A = -40^\circ\text{C}$ to $+85^\circ\text{C}$
	100		640	ms	$T_A = 85^\circ\text{C}$ to 125°C
$\overline{\text{RESET}}$ OUTPUT VOLTAGE					
Low (ADM6711/ADM6713)			0.3	V	$V_{CC} = V_{TH}$ min, $I_{SINK} = 1.2\text{ mA}$, ADM671_R/S/T/Z
			0.4	V	$V_{CC} = V_{TH}$ min, $I_{SINK} = 3.2\text{ mA}$, ADM671_L/M
High (ADM6711)			0.3	V	$V_{CC} > 1.0\text{ V}$, $I_{SINK} = 50\text{ }\mu\text{A}$
	$0.8 V_{CC}$			V	$V_{CC} > V_{TH}$ max, $I_{SOURCE} = 500\text{ }\mu\text{A}$, ADM6711R/S/T/Z
	$0.8 V_{CC}$			V	$V_{CC} > V_{TH}$ max, $I_{SOURCE} = 800\text{ }\mu\text{A}$, ADM6711L/M

Parameter	Min	Typ	Max	Unit	Test Conditions/Comments
RESET OPEN-DRAIN OUTPUT LEAKAGE CURRENT			1	μA	$V_{CC} > V_{TH}$, $\overline{\text{RESET}}$ deasserted
MANUAL RESET (MR)					
Input Threshold			$0.3 V_{CC}$	V	V_{IL}
	$0.7 V_{CC}$			V	V_{IH}
Pull-Up Resistance	10	20		$k\Omega$	
Minimum Pulse width	1			μs	
Glitch Immunity		100		ns	
Reset Delay		200		ns	

ABSOLUTE MAXIMUM RATINGS

$T_A = 25^\circ\text{C}$, unless otherwise noted.

Table 2.

Parameter	Rating
V_{CC}	-0.3 V to +6 V
$\overline{\text{RESET}}$ (Push-Pull)	-0.3 V to ($V_{CC} + 0.3$ V)
$\overline{\text{RESET}}$ (Open-Drain)	-0.3 V to +6 V
$\overline{\text{MR}}$	-0.3 V to ($V_{CC} + 0.3$ V)
Input Current $V_{CC}, \overline{\text{MR}}$	20 mA
Output Current $\overline{\text{RESET}}$	20 mA
Rate of Rise, V_{CC}	100 V/ μs
θ_{JA} Thermal Impedance, SC70	146°C/W
Operating Temperature Range	-40°C to +125°C
Storage Temperature Range	-65°C to +150°C
Lead Temperature (Soldering, 10 sec)	300°C

Stresses above those listed under Absolute Maximum Ratings may cause permanent damage to the device. This is a stress rating only; functional operation of the device at these or any other conditions above those indicated in the operational section of this specification is not implied. Exposure to absolute maximum rating conditions for extended periods may affect device reliability.

Table 3. $\overline{\text{RESET}}$ Threshold Options

Model	$\overline{\text{RESET}}$ Threshold (V)
ADM671_L	4.63
ADM671_M	4.38
ADM671_T	3.08
ADM671_S	2.93
ADM671_R	2.63
ADM671_Z	2.32

ESD CAUTION



ESD (electrostatic discharge) sensitive device. Charged devices and circuit boards can discharge without detection. Although this product features patented or proprietary protection circuitry, damage may occur on devices subjected to high energy ESD. Therefore, proper ESD precautions should be taken to avoid performance degradation or loss of functionality.

PIN CONFIGURATION AND FUNCTION DESCRIPTIONS

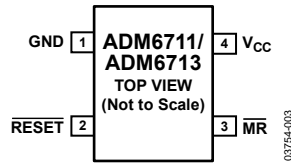

Figure 4. Pin Configuration

Table 4. Pin Function Descriptions

Pin No.	Mnemonic	Description
1	GND	Ground Reference for All Signals (0 V).
2	$\overline{\text{RESET}}$	Active Low Logic Input. $\overline{\text{RESET}}$ remains low while V_{CC} is below the reset threshold and remains low for 240 ms (typical) after V_{CC} rises above the reset threshold.
3	$\overline{\text{MR}}$	Manual Reset. This active low debounced input ignores input pulses of 100 ns (typical) and is guaranteed to accept input pulses greater than 1 μ s. Leave floating when not used.
4	V_{CC}	Supply Voltage Being Monitored.

TYPICAL PERFORMANCE CHARACTERISTICS

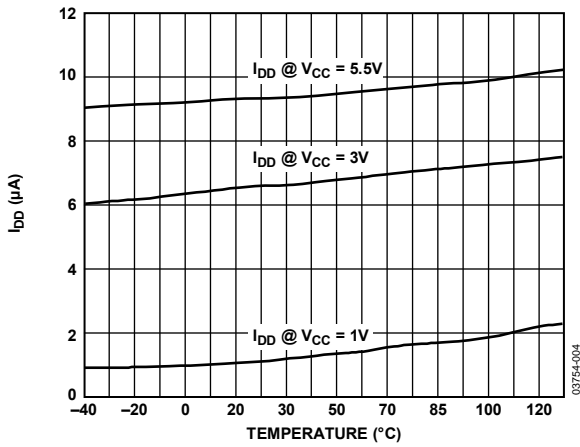

Figure 5. Supply Current vs. Temperature

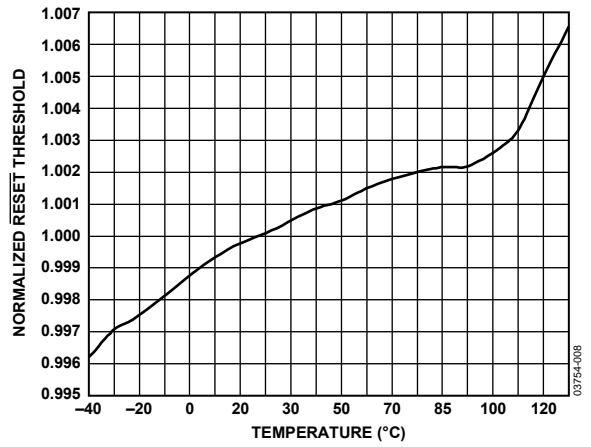

Figure 8. $\overline{\text{RESET}}$ Threshold Deviation vs. Temperature



Figure 6. Power-Down $\overline{\text{RESET}}$ Delay vs. Temperature: ADM671_R/ADM671_S/ADM671_T/ADM671_Z

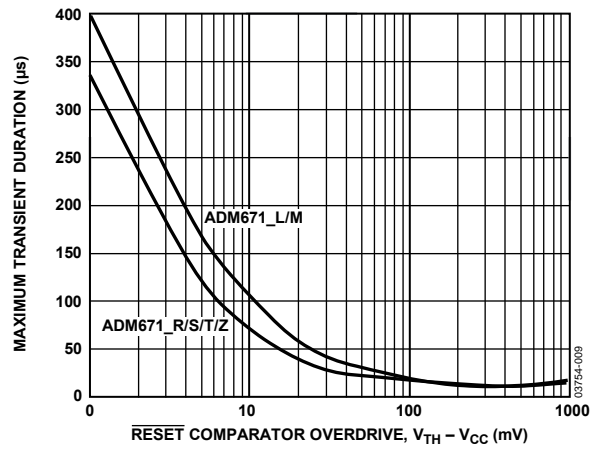

Figure 9. Maximum Transient Duration (Without Causing a $\overline{\text{RESET}}$ Pulse) vs. $\overline{\text{RESET}}$ Comparator Overdrive

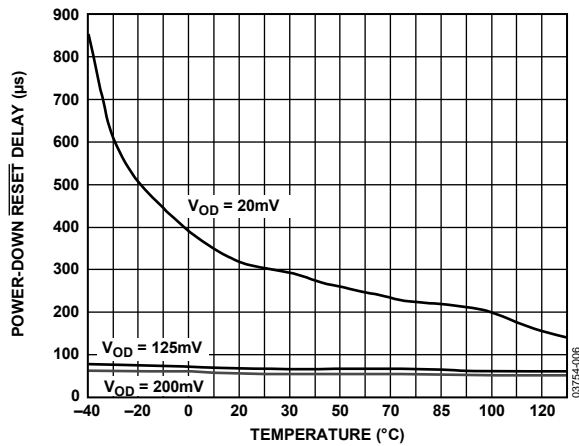

Figure 7. Power-Down $\overline{\text{RESET}}$ Delay vs. Temperature: ADM671_L/ADM671_M

CIRCUIT DESCRIPTION

The ADM6711/ADM6713 are designed to protect the integrity of a system's operation by ensuring the proper operation of the system during power-up, power-down, and brownout conditions.

When the ADM6711/ADM6713 are powered up, the $\overline{\text{RESET}}$ output remains low for a period equal to the typical reset active timeout period. This is designed to give the system time to power up correctly and for the power supply to stabilize before any devices are brought out of reset and allowed to begin executing instructions. Initializing a system in this way provides a more reliable startup for microprocessor systems.

MANUAL RESET INPUT

The ADM6711/ADM6713 manual reset ($\overline{\text{MR}}$) input allows the system operator to reset a system by means of an external manual switch. Alternatively, a logic signal from another digital circuit can be used to trigger a reset via the $\overline{\text{MR}}$ input.

The $\overline{\text{MR}}$ input ignores negative-going pulses faster than 100 ns (typical) and is guaranteed to accept any negative-going input pulse of a duration greater than or equal to 1 μs . The $\overline{\text{RESET}}$ output remains low while $\overline{\text{MR}}$ is held low and for 240 ms (typical) after $\overline{\text{MR}}$ returns high.

If $\overline{\text{MR}}$ is connected to long cables or is used in a noisy environment, then placing a 0.1 μF capacitor between the $\overline{\text{MR}}$ input and ground helps to remove any fast, negative-going transients.

POWER SUPPLY GLITCH IMMUNITY

The ADM6711/ADM6713 contain internal filtering circuitry that provides immunity to fast transient glitches on the power supply line. Figure 9 illustrates glitch immunity performance by showing the maximum transient duration without causing a reset pulse for glitches with amplitudes in the range of 1 mV to 1000 mV.

Glitch immunity makes the ADM6711/ADM6713 suitable for use in noisy environments. Mounting a 0.1 μF decoupling capacitor as close as possible to the V_{CC} pin improves glitch immunity further.

ADM6713 $\overline{\text{RESET}}$ OUTPUT LOGIC LEVELS

The ADM6713 open-drain $\overline{\text{RESET}}$ output is designed for use with an external pull-up resistor. This resistor can be tied to V_{CC} or any other reasonable voltage level, offering the flexibility to use the ADM6713 to drive a variety of different logic level circuitry.

ENSURING A VALID $\overline{\text{RESET}}$ OUTPUT DOWN TO $V_{\text{CC}} = 0 \text{ V}$

When V_{CC} falls below 0.8 V, the ADM6711/ADM6713 $\overline{\text{RESET}}$ output no longer sinks current, and a high impedance CMOS logic input connected to $\overline{\text{RESET}}$ may drift to undetermined logic levels. To eliminate this problem, a pull-down resistor is connected from $\overline{\text{RESET}}$ to ground. A 100 k Ω resistor is large enough not to load $\overline{\text{RESET}}$ and small enough to pull $\overline{\text{RESET}}$ to ground.



Figure 10. Ensuring a Valid $\overline{\text{RESET}}$ Output Down to $V_{\text{CC}} = 0 \text{ V}$

OUTLINE DIMENSIONS

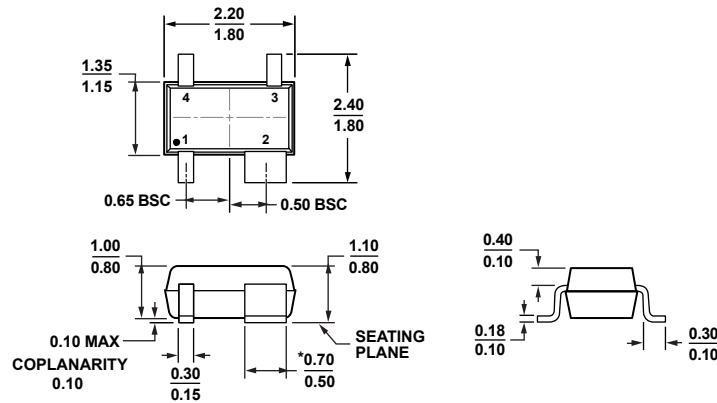

*PACKAGE OUTLINE CORRESPONDS IN FULL TO EIAJ SC82 EXCEPT FOR WIDTH OF PIN 2 AS SHOWN.

Figure 11. 4-Lead Thin Shrink Small Outline Transistor Package [SC70] (KS-4)

Dimensions shown in millimeters

072809-A

ORDERING GUIDE

Model ¹	RESET Threshold (V)	Temperature Range	Package Description	Package Option	Ordering Quantity (k)	Branding
ADM6711LAKS-REEL	4.63	-40°C to +125°C	4-Lead SC70	KS-4	10	M0B
ADM6711LAKSZ-REEL	4.63	-40°C to +125°C	4-Lead SC70	KS-4	10	M4U
ADM6711LAKSZ-REEL7	4.63	-40°C to +125°C	4-Lead SC70	KS-4	3	M4U
ADM6711MAKS-REEL	4.38	-40°C to +125°C	4-Lead SC70	KS-4	10	M0C
ADM6711MAKS-REEL7	4.38	-40°C to +125°C	4-Lead SC70	KS-4	3	M0C
ADM6711MAKSZ-REEL7	4.38	-40°C to +125°C	4-Lead SC70	KS-4	3	M86
ADM6711TAKS-REEL	3.08	-40°C to +125°C	4-Lead SC70	KS-4	10	M0D
ADM6711TAKSZ-REEL	3.08	-40°C to +125°C	4-Lead SC70	KS-4	10	M4A
ADM6711TAKS-REEL7	3.08	-40°C to +125°C	4-Lead SC70	KS-4	3	M0D
ADM6711TAKSZ-REEL7	3.08	-40°C to +125°C	4-Lead SC70	KS-4	3	M4A
ADM6711SAKS-REEL	2.93	-40°C to +125°C	4-Lead SC70	KS-4	10	M0E
ADM6711SAKSZ-REEL	2.93	-40°C to +125°C	4-Lead SC70	KS-4	10	M4B
ADM6711SAKS-REEL7	2.93	-40°C to +125°C	4-Lead SC70	KS-4	3	M0E
ADM6711SAKSZ-REEL7	2.93	-40°C to +125°C	4-Lead SC70	KS-4	3	M4B
ADM6711RAKS-REEL	2.63	-40°C to +125°C	4-Lead SC70	KS-4	10	M0F
ADM6711RAKSZ-REEL	2.63	-40°C to +125°C	4-Lead SC70	KS-4	10	M5F
ADM6711RAKS-REEL7	2.63	-40°C to +125°C	4-Lead SC70	KS-4	3	M0F
ADM6711RAKSZ-REEL7	2.63	-40°C to +125°C	4-Lead SC70	KS-4	3	M5F
ADM6711ZAKS-REEL	2.32	-40°C to +125°C	4-Lead SC70	KS-4	10	M0G
ADM6711ZAKSZ-REEL	2.32	-40°C to +125°C	4-Lead SC70	KS-4	10	M4H
ADM6711ZAKS-REEL7	2.32	-40°C to +125°C	4-Lead SC70	KS-4	3	M0G
ADM6711ZAKSZ-REEL7	2.32	-40°C to +125°C	4-Lead SC70	KS-4	3	M4H
ADM6713LAKS-REEL	4.63	-40°C to +125°C	4-Lead SC70	KS-4	10	M0H
ADM6713LAKSZ-REEL	4.63	-40°C to +125°C	4-Lead SC70	KS-4	10	M87
ADM6713LAKSZ-REEL7	4.63	-40°C to +125°C	4-Lead SC70	KS-4	3	M87
ADM6713MAKS-REEL	4.38	-40°C to +125°C	4-Lead SC70	KS-4	10	M0J
ADM6713MAKS-REEL7	4.38	-40°C to +125°C	4-Lead SC70	KS-4	3	M0J
ADM6713MAKSZ-REEL7	4.38	-40°C to +125°C	4-Lead SC70	KS-4	3	M88
ADM6713TAKS-REEL	3.08	-40°C to +125°C	4-Lead SC70	KS-4	10	M0K

Model ¹	RESET Threshold (V)	Temperature Range	Package Description	Package Option	Ordering Quantity (k)	Branding
ADM6713TAKS-REEL7	3.08	-40°C to +125°C	4-Lead SC70	KS-4	3	M0K
ADM6713TAKSZ-REEL7	3.08	-40°C to +125°C	4-Lead SC70	KS-4	3	M89
ADM6713SAKS-REEL	2.93	-40°C to +125°C	4-Lead SC70	KS-4	10	M0L
ADM6713SAKSZ-REEL	2.93	-40°C to +125°C	4-Lead SC70	KS-4	10	M57
ADM6713SAKS-REEL7	2.93	-40°C to +125°C	4-Lead SC70	KS-4	3	M0L
ADM6713SAKSZ-REEL7	2.93	-40°C to +125°C	4-Lead SC70	KS-4	3	M57
ADM6713RAKS-REEL	2.63	-40°C to +125°C	4-Lead SC70	KS-4	10	M0M
ADM6713RAKSZ-REEL	2.63	-40°C to +125°C	4-Lead SC70	KS-4	10	M4S
ADM6713RAKS-REEL7	2.63	-40°C to +125°C	4-Lead SC70	KS-4	3	M0M
ADM6713RAKSZ-REEL7	2.63	-40°C to +125°C	4-Lead SC70	KS-4	3	M4S
ADM6713ZAKS-REEL	2.32	-40°C to +125°C	4-Lead SC70	KS-4	10	M0N
ADM6713ZAKSZ-REEL	2.32	-40°C to +125°C	4-Lead SC70	KS-4	10	M4R
ADM6713ZAKS-REEL7	2.32	-40°C to +125°C	4-Lead SC70	KS-4	3	M0N
ADM6713ZAKSZ-REEL7	2.32	-40°C to +125°C	4-Lead SC70	KS-4	3	M4R

¹ Z = RoHS Compliant Part.

NOTES

NOTES