

FEATURES

- Quad UV/OV positive/negative supervisor
- Supervises up to 2 negative rails
- Adjustable UV and OV input thresholds
- High threshold accuracy over temperature: $\pm 1.5\%$
- 1 V buffered reference output
- Open-drain \overline{UV} and \overline{OV} reset outputs
- Adjustable reset timeout
- Outputs guaranteed down to V_{CC} of 1 V
- Glitch immunity
- 62 μA supply current
- 16-lead QSOP package

ENHANCED PRODUCT FEATURES

Operating temperature range of -55°C to $+125^{\circ}\text{C}$

APPLICATIONS

- Server supply monitoring
- FPGA/DSP core and I/O voltage monitoring
- Telecommunications equipment
- Medical equipment

GENERAL DESCRIPTION

The ADM2914-EP is a quad voltage supervisory IC ideally suited for monitoring multiple rails in a wide range of applications.

Each monitored rail has two dedicated input pins, VH_x and VL_x , which allow each rail to be monitored for both overvoltage (OV) and undervoltage (UV) conditions. A common active low undervoltage (\overline{UV}) and overvoltage (\overline{OV}) pin is shared by each of the monitored voltage rails.

The ADM2914-EP includes a 1 V buffered reference output, REF, that acts as an offset when monitoring a negative voltage. The three-state SEL pin determines the polarity of the third and fourth inputs, that is, it configures the device to monitor positive or negative supplies.

FUNCTIONAL BLOCK DIAGRAM

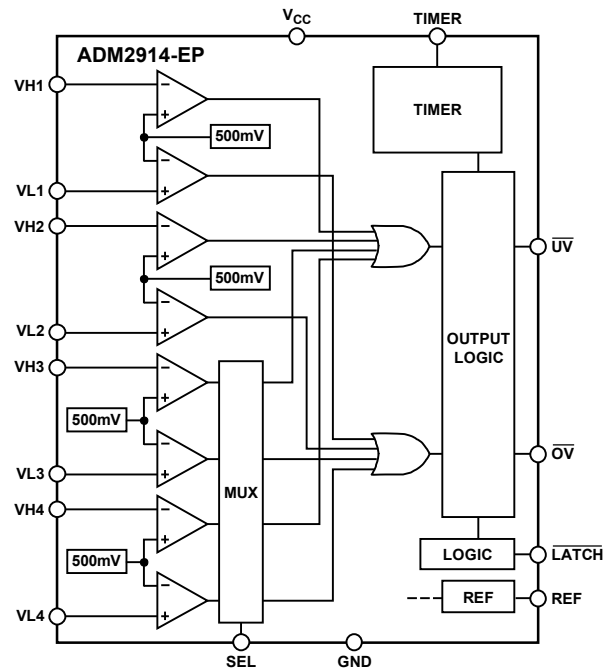

Figure 1.

The device incorporates an internal shunt regulator that enables the device to be used in higher voltage systems. This feature requires a resistor to be placed between the main supply rail and the V_{CC} pin to limit the current flow into the V_{CC} pin to no greater than 10 mA. The ADM2914-EP uses the internal shunt regulator to regulate V_{CC} if the supply line exceeds the absolute maximum ratings.

The ADM2914-EP offers a latching overvoltage output that can be cleared by toggling the \overline{LATCH} input pin.

The ADM2914-EP is available in a 16-lead QSOP package. The device operates over the extended temperature range of -55°C to $+125^{\circ}\text{C}$.

Additional application and technical information can be found in the [ADM2914](#) data sheet.

Rev. 0

Information furnished by Analog Devices is believed to be accurate and reliable. However, no responsibility is assumed by Analog Devices for its use, nor for any infringements of patents or other rights of third parties that may result from its use. Specifications subject to change without notice. No license is granted by implication or otherwise under any patent or patent rights of Analog Devices. Trademarks and registered trademarks are the property of their respective owners.

TABLE OF CONTENTS

Features	1	Absolute Maximum Ratings	4
Enhanced Product Features	1	ESD Caution.....	4
Applications.....	1	Pin Configuration and Function Descriptions.....	5
Functional Block Diagram	1	Typical Performance Characteristics	6
General Description	1	Outline Dimensions	8
Revision History	2	Ordering Guide	8
Specifications.....	3		

REVISION HISTORY

6/11—Revision 0: Initial Version

SPECIFICATIONS

$T_A = -55^\circ\text{C}$ to $+125^\circ\text{C}$. Typical values at $T_A = 25^\circ\text{C}$, unless otherwise noted. $V_{CC} = 3.3\text{ V}$, $V_{LX} = 0.45\text{ V}$, $V_{HX} = 0.55\text{ V}$, $\overline{\text{LATCH}} = V_{CC}$, $\text{SEL} = V_{CC}$, unless otherwise noted.

Table 1.

Parameter	Min	Typ	Max	Unit	Test Conditions/Comments
SHUNT REGULATOR					
V_{CC} Shunt Regulator Voltage, V_{SHUNT}	6.2	6.6	6.9	V	$I_{CC} = 5\text{ mA}$
	6.2	6.6	7.0	V	$T_A = -55^\circ\text{C}$ to $+125^\circ\text{C}$
V_{CC} Shunt Regulator Load Regulation, ΔV_{SHUNT}		200	300	mV	$I_{CC} = 2\text{ mA}$ to 10 mA
SUPPLY					
Supply Voltage, V_{CC}^1	2.3		V_{SHUNT}	V	
Minimum V_{CC} Output Valid, $V_{CCR(MIN)}$			1	V	
Supply Undervoltage Lockout, $V_{CC(UVLO)}$	1.9	2	2.1	V	V_{CC} rising
Supply Undervoltage Lockout Hysteresis, $\Delta V_{CC(HYST)}$	5	25	50	mV	
Supply Current, I_{CC}		62	100	μA	$V_{CC} = 2.3\text{ V}$ to 6 V
REFERENCE OUTPUT					
Reference Output Voltage, V_{REF}	0.985	1	1.015	V	$I_{VREF} = \pm 1\text{ mA}$
	0.985	1	1.020	V	$T_A = -55^\circ\text{C}$ to $+125^\circ\text{C}$
UNDERVOLTAGE/OVERVOLTAGE CHARACTERISTICS					
Undervoltage/Overvoltage Threshold, V_{UOT}	492.5	500	507.5	mV	
Undervoltage/Overvoltage Threshold to Output Delay, t_{UOD}	50	125	500	μs	$V_{HX} = V_{UOT} - 5\text{ mV}$ or $V_{LX} = V_{UOT} + 5\text{ mV}$
V_{HX} , V_{LX} Input Current, I_{VHL}			± 15	nA	
			± 30	nA	$T_A = -55^\circ\text{C}$ to $+125^\circ\text{C}$
$\overline{\text{UV/OV}}$ Timeout Period, t_{UOTO}	6	8.5	12.5	ms	$C_{TIMER} = 1\text{ nF}$
	6	8.5	14	ms	$T_A = -55^\circ\text{C}$ to $+125^\circ\text{C}$
$\overline{\text{OV}}$ LATCH CLEAR INPUT					
$\overline{\text{OV}}$ Latch Clear Threshold Input High, $V_{LATCH(HI)}$	1.2			V	
$\overline{\text{OV}}$ Latch Clear Threshold Input Low, $V_{LATCH(LI)}$			0.8	V	
$\overline{\text{LATCH}}$ Input Current, I_{LATCH}			± 1	μA	$V_{LATCH} > 0.5\text{ V}$
TIMER CHARACTERISTICS					
TIMER Pull-Up Current, $I_{TIMER(UP)}$	-1.3	-2.1	-2.8	μA	$V_{TIMER} = 0\text{ V}$
	-1.2	-2.1	-2.8	μA	$T_A = -55^\circ\text{C}$ to $+125^\circ\text{C}$
TIMER Pull-Down Current, $I_{TIMER(DOWN)}$	1.3	2.1	2.8	μA	$V_{TIMER} = 1.6\text{ V}$
	1.2	2.1	2.8	μA	$T_A = -55^\circ\text{C}$ to $+125^\circ\text{C}$
TIMER Disable Voltage, $V_{TIMER(DIS)}$	-180	-270		mV	Referenced to V_{CC}
OUTPUT VOLTAGE					
Output Voltage High, $\overline{\text{UV/OV}}$, V_{OH}	1			V	$V_{CC} = 2.3\text{ V}$; $I_{\overline{\text{UV/OV}}} = -1\text{ }\mu\text{A}$
Output Voltage Low, $\overline{\text{UV/OV}}$, V_{OL}		0.1	0.3	V	$V_{CC} = 2.3\text{ V}$; $I_{\overline{\text{UV/OV}}} = 2.5\text{ mA}$
		0.01	0.15	V	$V_{CC} = 1\text{ V}$; $I_{\overline{\text{UV}}} = 100\text{ }\mu\text{A}$
THREE-STATE INPUT SEL					
Low Level Input Voltage, V_{IL}			0.4	V	
High Level Input Voltage, V_{IH}	1.4			V	
Pin Voltage When Left in High-Z State, V_Z	0.7	0.9	1.1	V	$I_{SEL} = \pm 10\text{ }\mu\text{A}$
	0.6	0.9	1.2	V	$T_A = -55^\circ\text{C}$ to $+125^\circ\text{C}$
SEL High, Low Input Current, I_{SEL}			± 25	μA	
Maximum SEL Input Current, $I_{SEL(MAX)}$			± 30	μA	SEL tied to V_{CC} or GND

¹ The maximum voltage on the V_{CC} pin is limited by the input current. The V_{CC} pin has an internal 6.5 V shunt regulator and, therefore, a low impedance supply greater than 6 V may exceed the maximum allowed input current. When operating from a higher supply than 6 V, always use a dropper resistor.

ABSOLUTE MAXIMUM RATINGS

Table 2.

Parameter	Rating
V_{CC}	-0.3 V to +6 V
\overline{UV} , \overline{OV}	-0.3 V to +16 V
TIMER	-0.3 V to ($V_{CC} + 0.3$ V)
V_{Lx} , V_{Hx} , \overline{LATCH} , \overline{SEL}	-0.3 V to +7.5 V
I_{CC}	10 mA
Reference Load Current (I_{REF})	± 1 mA
$I_{\overline{UV}}$, $I_{\overline{OV}}$	10 mA
Storage Temperature Range	-65°C to +150°C
Operating Temperature Range	-55°C to +125°C
Lead Temperature (Soldering, 10 sec)	300°C

Stresses above those listed under Absolute Maximum Ratings may cause permanent damage to the device. This is a stress rating only; functional operation of the device at these or any other conditions above those indicated in the operational section of this specification is not implied. Exposure to absolute maximum rating conditions for extended periods may affect device reliability.

Table 3. Thermal Resistance

Package Type	θ_{JA}	Unit
16-Lead QSOP	104	°C/W

ESD CAUTION



ESD (electrostatic discharge) sensitive device. Charged devices and circuit boards can discharge without detection. Although this product features patented or proprietary protection circuitry, damage may occur on devices subjected to high energy ESD. Therefore, proper ESD precautions should be taken to avoid performance degradation or loss of functionality.

PIN CONFIGURATION AND FUNCTION DESCRIPTIONS

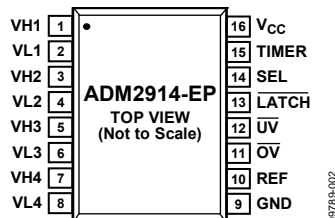

Figure 2. ADM2914-EP Pin Configuration

Table 4. Pin Function Descriptions

Pin No.	Mnemonic	Description
1	VH1	Voltage High Input 1 and Voltage High Input 2. If the voltage monitored by VH1 or VH2 drops below 0.5 V, an undervoltage condition is detected. Connect to V_{CC} when not in use.
3	VH2	
2	VL1	Voltage Low Input 1 and Voltage Low Input 2. If the voltage monitored by VL1 or VL2 rises above 0.5 V, an overvoltage condition is detected. Tie to GND when not in use.
4	VL2	
5	VH3	Voltage High Input 3 and Voltage High Input 4. The polarity of these inputs is determined by the state of the SEL pin. When the monitored input is configured as a positive voltage and the voltage monitored by VH3 or VH4 drops below 0.5 V, an undervoltage condition is detected. Conversely, when the input is configured as a negative voltage and the input drops below 0.5 V, an overvoltage condition is detected. Connect to V_{CC} when not in use.
7	VH4	
6	VL3	
8	VL4	Voltage Low Input 3 and Voltage Low Input 4. The polarity of these inputs is determined by the state of the SEL pin. When the monitored input is configured as a positive voltage and the voltage monitored by VL3 or VL4 rises above 0.5 V, an overvoltage condition is detected. Conversely, when the input is configured as a negative voltage and the input rises above 0.5 V, an undervoltage condition is detected. Tie to GND when not in use.
9	GND	
10	REF	Buffered Reference Output. This pin is a 1 V reference that is used as an offset when monitoring negative voltages. This pin can source or sink 1 mA and drive loads up to 1 nF. Larger capacitive loads may lead to instability. Leave unconnected when not in use.
11	\overline{OV}	Overvoltage Reset Output. \overline{OV} is asserted low if a negative polarity input voltage drops below its associated threshold or if a positive polarity input voltage exceeds its threshold. The ADM2914-EP allows \overline{OV} to be latched low. This pin has a weak pull-up to V_{CC} and can be pulled up to 16 V externally. Leave this pin unconnected when not in use.
12	\overline{UV}	Undervoltage Reset Output. \overline{UV} is asserted low if a negative polarity input voltage exceeds its associated threshold or if a positive polarity input voltage drops below its threshold. \overline{UV} is held low for an adjustable timeout period set by the external capacitor tied to the TIMER pin. The \overline{UV} pin has a weak pull-up to V_{CC} and can be pulled up to 16 V externally via an external pull-up resistor. Leave this pin unconnected when not in use.
13	\overline{LATCH}	\overline{OV} Latch Bypass Input/Clear Pin. When pulled high, the \overline{OV} latch is cleared. When held high, the \overline{OV} output has the same delay and output characteristics as the \overline{UV} output. When pulled low, the \overline{OV} output is latched when asserted.
14	SEL	Input Polarity Select. This three-state input pin allows the polarity of VH3, VL3, VH4, and VL4 to be configured. Connect to V_{CC} or GND, or leave open to select one of three possible input polarity configurations.
15	TIMER	Adjustable Reset Delay Timer. Connect an external capacitor to the TIMER pin to program the reset timeout delay. Refer to Figure 14 in the Typical Performance Characteristics section. Connect this pin to V_{CC} to bypass the timer.
16	V_{CC}	Supply Voltage. V_{CC} operates as a direct supply for voltages up to 6 V. For voltages greater than 6 V, it operates as a shunt regulator. A dropper resistor must be used in this configuration to limit the current to less than 10 mA. When used without the resistor, the voltage at this pin must not exceed 6 V. A 0.1 μ F bypass capacitor or greater should be used.

TYPICAL PERFORMANCE CHARACTERISTICS

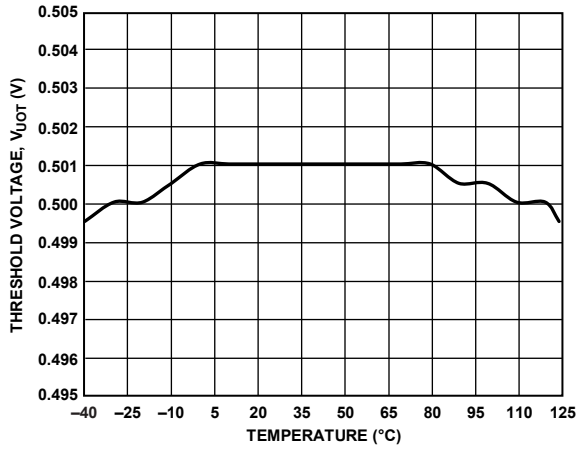

Figure 3. Input Threshold Voltage vs. Temperature

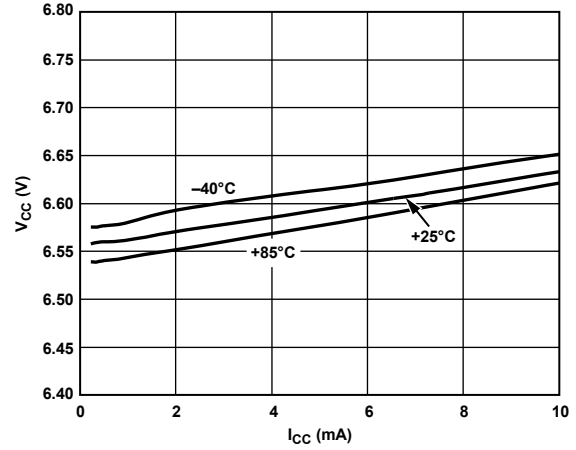

Figure 6. V_{CC} Shunt Voltage vs. I_{CC}

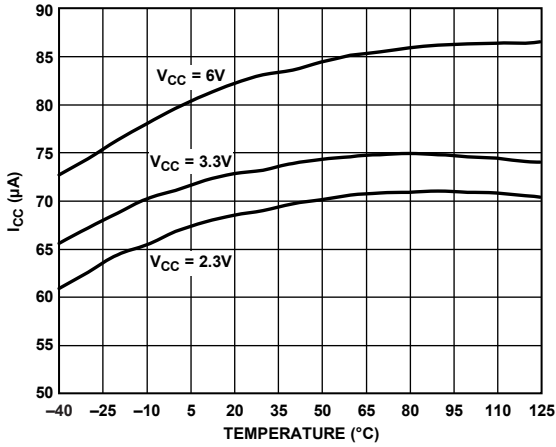

Figure 4. Supply Current vs. Temperature

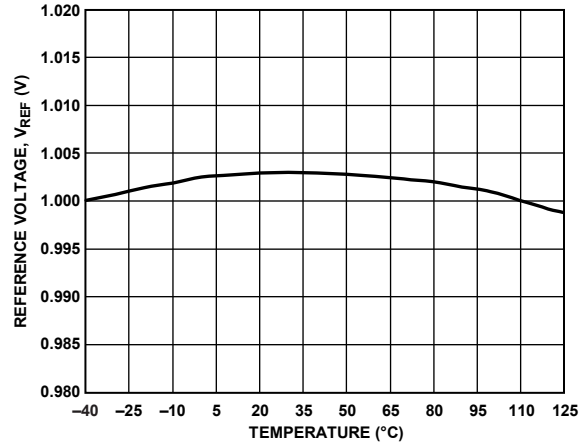

Figure 7. Buffered Reference Voltage vs. Temperature

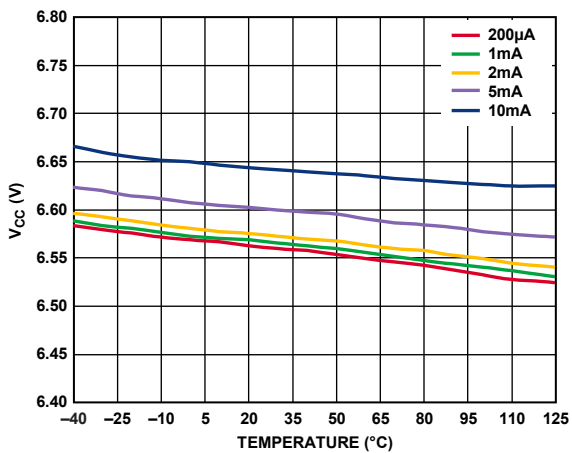

Figure 5. V_{CC} Shunt Voltage vs. Temperature

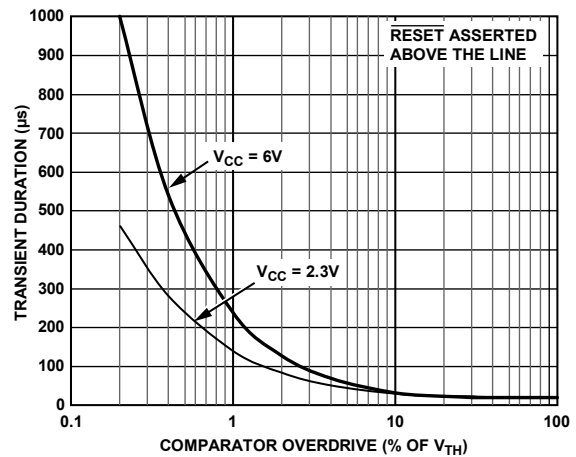

Figure 8. Transient Duration vs. Comparator Overdrive

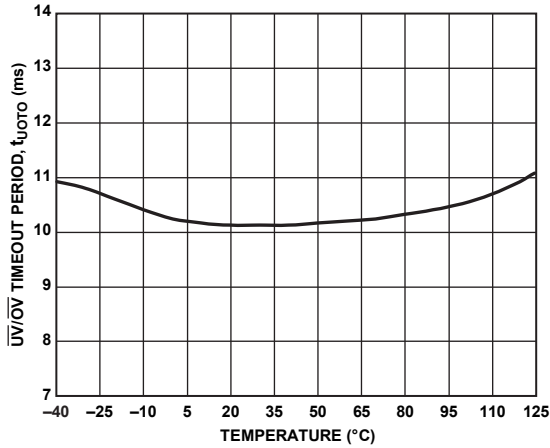

Figure 9. $\overline{UV/OV}$ Timeout Period vs. Temperature

09789-009

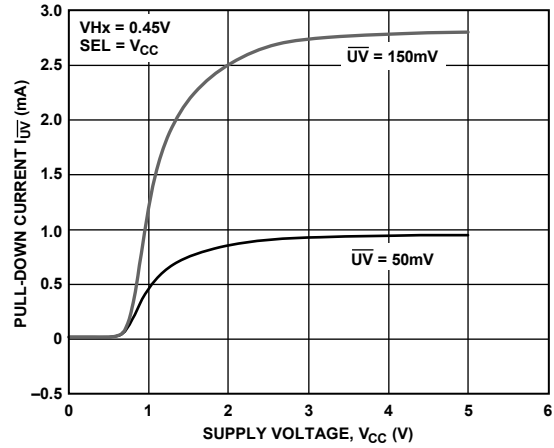

Figure 12. I_{SINK} , I_{UV} vs. V_{CC}

09789-012

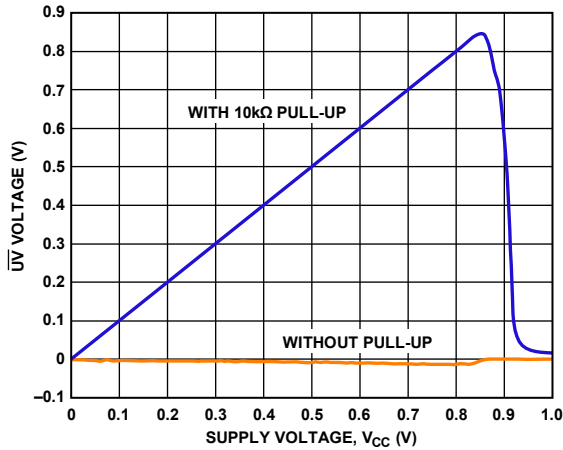

Figure 10. \overline{UV} Output Voltage vs. V_{CC}

09789-010

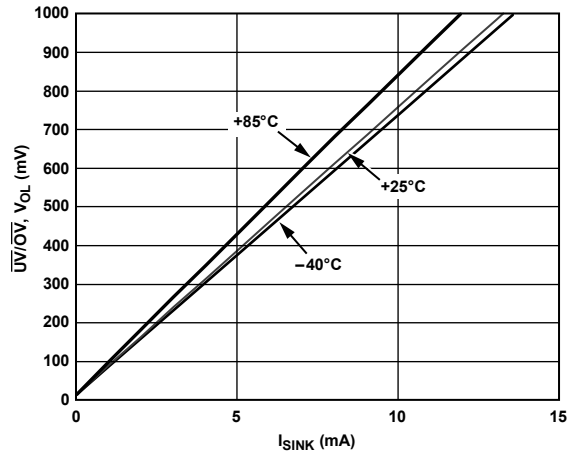

Figure 13. $\overline{UV/OV}$ Voltage Output Low vs. Output Sink Current

09789-013

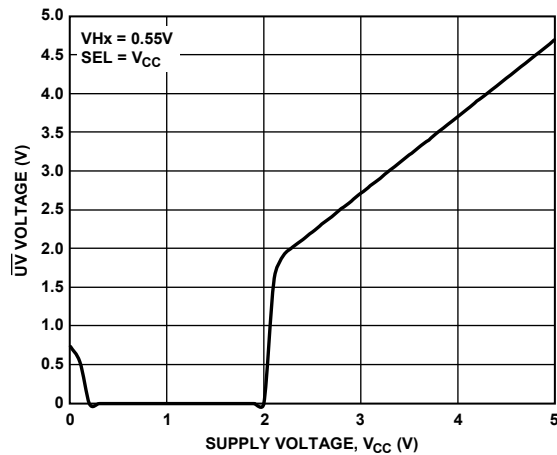

Figure 11. \overline{UV} Output Voltage vs. V_{CC}

09789-011

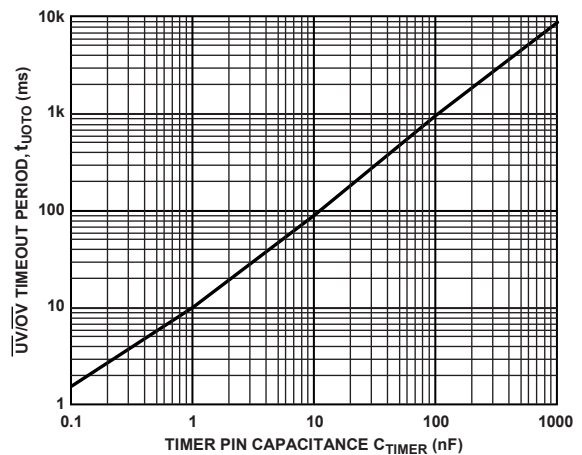
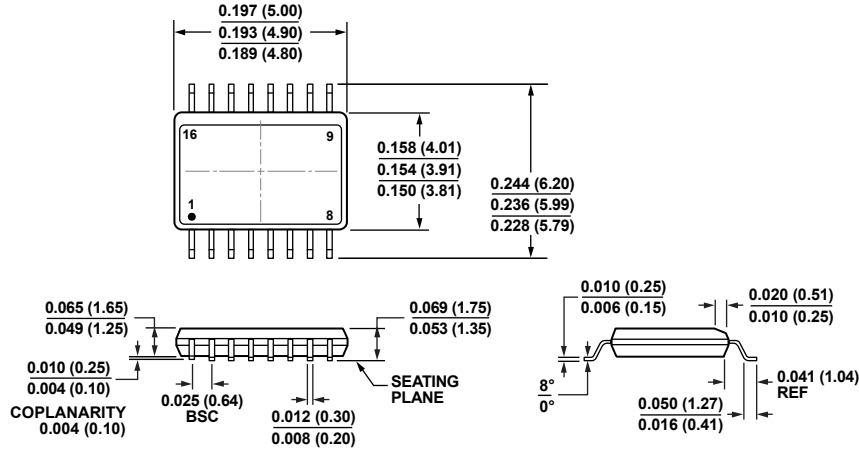

Figure 14. $\overline{UV/OV}$ Timeout Period vs. Capacitance

09789-014

ADM2914-EP

OUTLINE DIMENSIONS



COMPLIANT TO JEDEC STANDARDS MO-137-AB
CONTROLLING DIMENSIONS ARE IN INCHES; MILLIMETER DIMENSIONS
(IN PARENTHESES) ARE ROUNDED-OFF INCH EQUIVALENTS FOR
REFERENCE ONLY AND ARE NOT APPROPRIATE FOR USE IN DESIGN.

Figure 15. 16-Lead Shrink Small Outline Package [QSOP]
(RQ-16)

Dimensions shown in inches and (millimeters)

01-28-2008-A

ORDERING GUIDE

Model ¹	Temperature Range	Package Description	Package Option
ADM2914-1SRQZEP	-55°C to +125°C	16-Lead Shrink Small Outline Package [QSOP]	RQ-16
ADM2914-1SRQZEP-R7	-55°C to +125°C	16-Lead Shrink Small Outline Package [QSOP]	RQ-16

¹ Z = RoHS Compliant Part.