

Applications	Commercial Grade
Feature	Wire Wound Wire Wound Shield Magnetic Shield Ferrite Core Ferrite Core
Series Type	CLF
Status	Obsolete Recommended Alternate Part No. : CLF12555T-101M-D (Interchangeability is not guaranteed.) Discontinue Issue Date : May.18, 2017 Last Purchase Order Date : Mar.29, 2019 Last Shipment Date : Sep.30, 2019
Brand	TDK



Size	
Length(L)	12.50mm ±0.30mm
Width(W)	12.10mm +0.30,-0.20mm
Thickness Height	5.50mm ±0.35mm
Recommended Land Pattern (A)	2.70mm Nom.
Recommended Land Pattern (B)	8.30mm Nom.
Recommended Land Pattern (C)	3.20mm Nom.

Electrical Characteristics	
Inductance	100µH ±20% at 100kHz
Rated Current (L Change) [Typ.]	2.1A (10% Down)
Rated Current (L Change) [Max.]	
Rated Current (Temperature Rise) [Typ.]	1.3A (30°C Rise)
Rated Current (Temperature Rise) [Max.]	
DC Resistance [Typ.]	190mΩ
DC Resistance [Max.]	228mΩ
Self Resonant Frequency [Min.]	
Self Resonant Frequency [Typ.]	
Q [Min.]	
Q [Typ.]	

Other	
Operating Temp. Range (Including Self-Temp. Rise)	-40 to 105°C
Soldering Method	Reflow Iron Soldering
AEC-Q200	NO
Packing	Punched (Paper)Taping [330mm Reel]
Package Quantity	500pcs

Characteristic Graphs(This is reference data, and does not guarantee the products characteristics.)

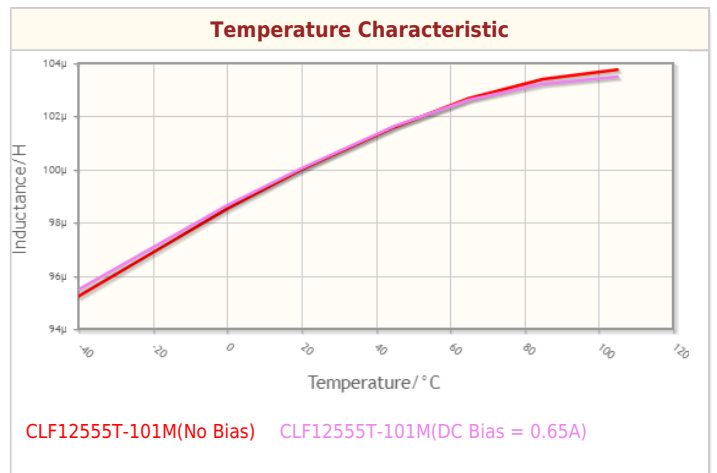
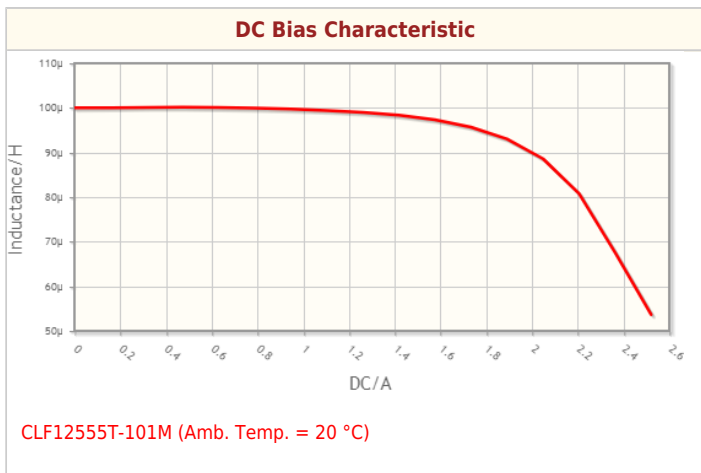
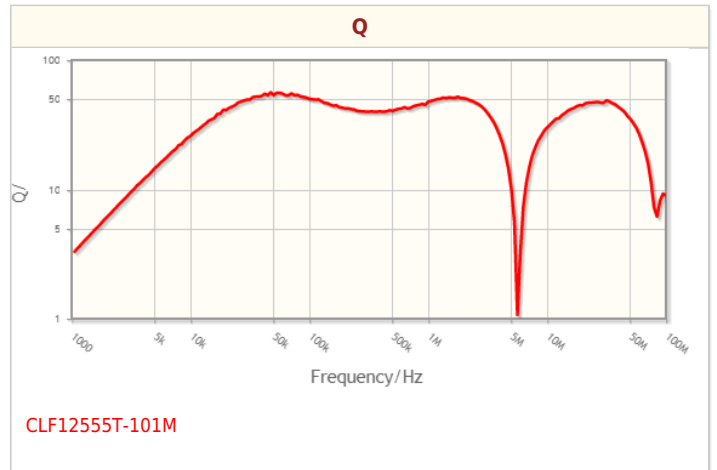
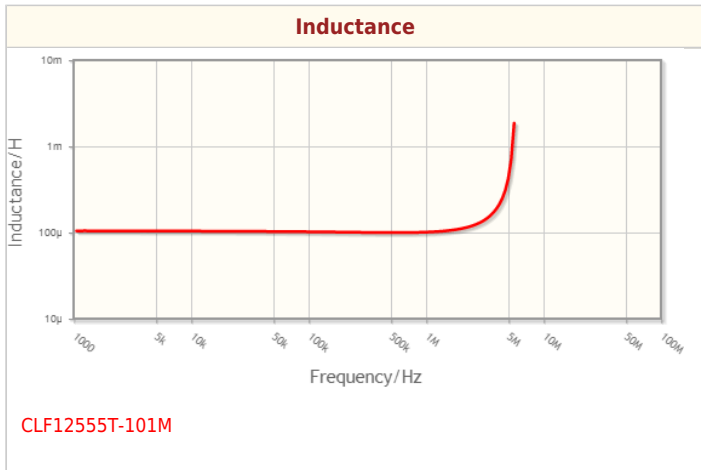
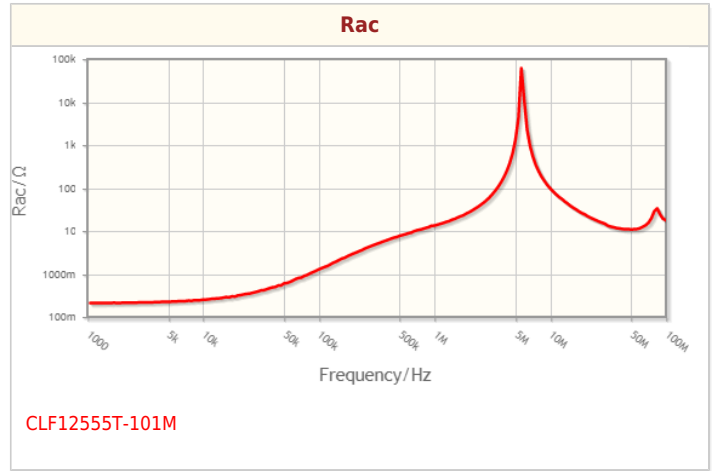
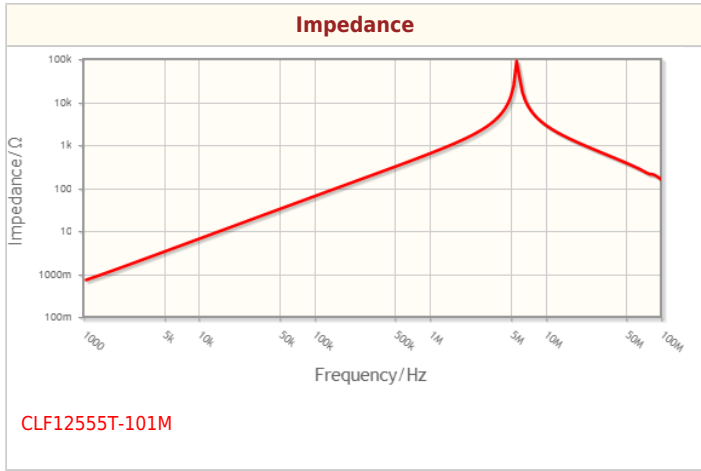

! Images are for reference only and show exemplary products.
! This PDF document was created based on the data listed on the TDK Corporation website.
! All specifications are subject to change without notice.

Characteristic Graphs(This is reference data, and does not guarantee the products characteristics.)

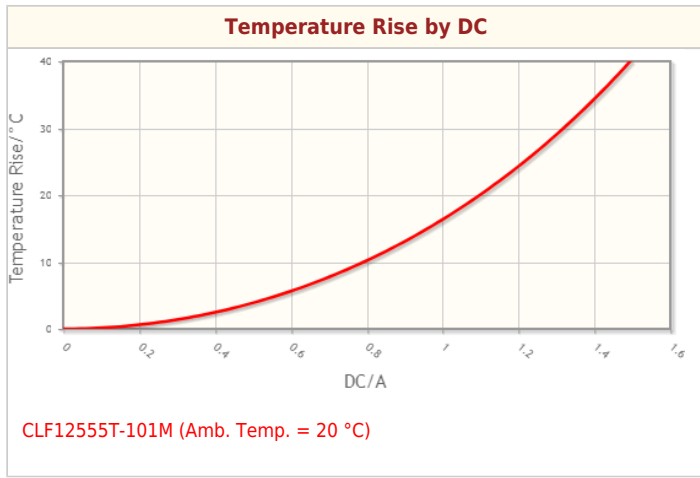

! Images are for reference only and show exemplary products.

! This PDF document was created based on the data listed on the TDK Corporation website.

! All specifications are subject to change without notice.

Copyright(c) TDK Corporation. All rights reserved.

Downloaded from [Arrow.com](https://arrow.com)

Associated Images

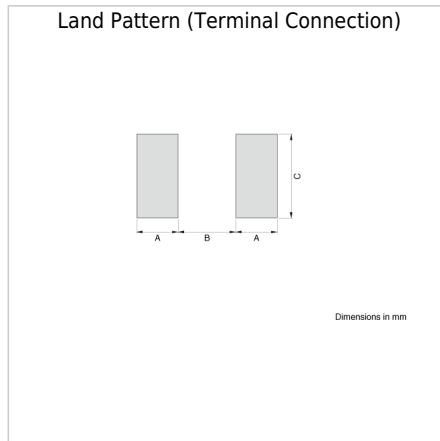
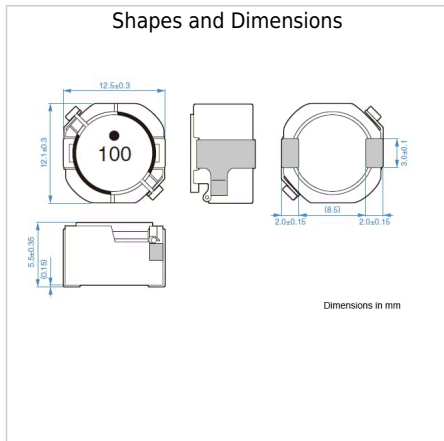

! Images are for reference only and show exemplary products.

! This PDF document was created based on the data listed on the TDK Corporation website.

! All specifications are subject to change without notice.

Copyright(c) TDK Corporation. All rights reserved.

Downloaded from Arrow.com