

FEATURES

Fixed gain of 17.4 dB
Broadband operation from 30 MHz to 6 GHz
Input/output internally matched to 50 Ω
Integrated bias control circuit
OIP3 of 34.9 dBm at 900 MHz
P1dB of 17.6 dBm at 900 MHz
Noise figure of 2.9 dB at 900 MHz
Single 5 V power supply
Low quiescent current of 55 mA
Wide operating temperature range of -40°C to $+105^{\circ}\text{C}$
Thermally efficient SOT-89 package
ESD rating of ± 1.5 kV (Class 1C)

GENERAL DESCRIPTION

The [ADL5544](#) is a single-ended RF/IF gain block amplifier that provides broadband operation from 30 MHz to 6 GHz. The [ADL5544](#) provides over 34 dBm of OIP3 using only 55 mA from a 5 V supply.

The [ADL5544](#) provides a gain of 17 dB, which is stable over frequency, temperature, power supply, and from device to device. The amplifier is offered in the industry-standard SOT-89 package and is internally matched to 50 Ω at the input and output, making the [ADL5544](#) very easy to implement in a wide variety of applications. The only external components required are the input/output ac coupling capacitors, power supply decoupling capacitors, and dc bias inductor.

FUNCTIONAL BLOCK DIAGRAM

Figure 1.

The [ADL5544](#) is fabricated on an InGaP HBT process and has a high ESD rating of ± 1.5 kV (Class 1C). The [ADL5544](#) is also fully specified for operation across the wide temperature range of -40°C to $+105^{\circ}\text{C}$. A fully populated RoHS-compliant evaluation board is available.

Rev. A

[Document Feedback](#)

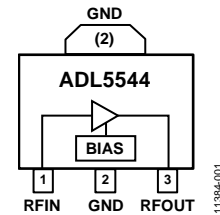
Information furnished by Analog Devices is believed to be accurate and reliable. However, no responsibility is assumed by Analog Devices for its use, nor for any infringements of patents or other rights of third parties that may result from its use. Specifications subject to change without notice. No license is granted by implication or otherwise under any patent or patent rights of Analog Devices. Trademarks and registered trademarks are the property of their respective owners.

One Technology Way, P.O. Box 9106, Norwood, MA 02062-9106, U.S.A.
Tel: 781.329.4700 ©2013 Analog Devices, Inc. All rights reserved.
[Technical Support](#) www.analog.com

TABLE OF CONTENTS

Features	1	100 MHz to 500 MHz Frequency Band	10
Functional Block Diagram	1	4 GHz to 6 GHz Frequency Band	11
General Description	1	General.....	12
Revision History	2	Applications Information	14
Specifications.....	3	Basic Connections.....	14
Typical Scattering Parameters (S-Parameters)	5	Soldering Information and Recommended	
Absolute Maximum Ratings.....	7	PCB Land Pattern.....	15
Thermal Resistance	7	Operation Down to 30 MHz.....	16
ESD Caution.....	7	W-CDMA ACPR Performance	16
Pin Configuration and Function Descriptions.....	8	Evaluation Board	17
Typical Performance Characteristics	9	Outline Dimensions	18
500 MHz to 4 GHz Frequency Band.....	9	Ordering Guide	18

REVISION HISTORY

11/13—Rev. 0 to Rev. A

Added Figure 25, Renumbered Sequentially	12
Changes to Figure 34.....	15
Updated Outline Dimensions	18

4/13—Revision 0: Initial Version

SPECIFICATIONS

$V_{POS} = 5\text{ V}$ and $T_A = 25^\circ\text{C}$, unless otherwise noted.

Table 1.

Parameter	Test Conditions/Comments	Min	Typ	Max	Unit
OVERALL FUNCTION Frequency Range		30		6000	MHz
FREQUENCY = 30 MHz Gain Output 1 dB Compression Point Output Third-Order Intercept Noise Figure	$\Delta f = 1\text{ MHz}$, output power (P_{OUT}) = -7 dBm per tone		18.5 13.0 31.2 3.9		dB dBm dBm dB
FREQUENCY = 140 MHz Gain vs. Frequency vs. Temperature vs. Supply Output 1 dB Compression Point Output Third-Order Intercept Noise Figure	$\pm 10\text{ MHz}$ $-40^\circ\text{C} \leq T_A \leq +85^\circ\text{C}$ 4.75 V to 5.25 V $\Delta f = 1\text{ MHz}$, output power (P_{OUT}) = -7 dBm per tone		18.04 ± 0.04 ± 0.3 ± 0.05 16.9 32.0 3.1		dB dB dB dB dBm dBm dB
FREQUENCY = 350 MHz Gain vs. Frequency vs. Temperature vs. Supply Output 1 dB Compression Point Output Third-Order Intercept Noise Figure	$\pm 10\text{ MHz}$ $-40^\circ\text{C} \leq T_A \leq +85^\circ\text{C}$ 4.75 V to 5.25 V $\Delta f = 1\text{ MHz}$, output power (P_{OUT}) = -7 dBm per tone		17.8 ± 0.01 ± 0.3 ± 0.06 17.4 31.2 3.1		dB dB dB dB dBm dBm dB
FREQUENCY = 700 MHz Gain vs. Frequency vs. Temperature vs. Supply Output 1 dB Compression Point Output Third-Order Intercept Noise Figure	$\pm 50\text{ MHz}$ $-40^\circ\text{C} \leq T_A \leq +85^\circ\text{C}$ 4.75 V to 5.25 V $\Delta f = 1\text{ MHz}$, output power (P_{OUT}) = -7 dBm per tone	17.1	17.6 ± 0.03 ± 0.3 ± 0.02 17.4 33.4 2.9	18.0	dB dB dB dB dBm dBm dB
FREQUENCY = 900 MHz Gain vs. Frequency vs. Temperature vs. Supply Output 1 dB Compression Point Output Third-Order Intercept Noise Figure	$\pm 50\text{ MHz}$ $-40^\circ\text{C} \leq T_A \leq +85^\circ\text{C}$ 4.75 V to 5.25 V $\Delta f = 1\text{ MHz}$, output power (P_{OUT}) = -7 dBm per tone	17.0	17.4 ± 0.03 ± 0.3 ± 0.02 17.6 34.9 2.9	17.8	dB dB dB dB dBm dBm dB
FREQUENCY = 1900 MHz Gain vs. Frequency vs. Temperature vs. Supply Output 1 dB Compression Point Output Third-Order Intercept Noise Figure	$\pm 50\text{ MHz}$ $-40^\circ\text{C} \leq T_A \leq +85^\circ\text{C}$ 4.75 V to 5.25 V $\Delta f = 1\text{ MHz}$, output power (P_{OUT}) = -7 dBm per tone	16.2	16.6 ± 0.05 ± 0.3 ± 0.04 15.4 32.4 3.4	17.0	dB dB dB dB dBm dBm dB

Parameter	Test Conditions/Comments	Min	Typ	Max	Unit
FREQUENCY = 2140 MHz					
Gain		15.9	16.4	16.7	dB
vs. Frequency	±50 MHz		±0.04		dB
vs. Temperature	−40°C ≤ T _A ≤ +85°C		±0.4		dB
vs. Supply	4.75 V to 5.25 V		±0.05		dB
Output 1 dB Compression Point			14.8		dBm
Output Third-Order Intercept	Δf = 1 MHz, output power (P _{OUT}) = −7 dBm per tone		31.3		dBm
Noise Figure			3.5		dB
FREQUENCY = 2600 MHz					
Gain		15.6	16.0	16.4	dB
vs. Frequency	±50 MHz		±0.03		dB
vs. Temperature	−40°C ≤ T _A ≤ +85°C		±0.3		dB
vs. Supply	4.75 V to 5.25 V		±0.05		dB
Output 1 dB Compression Point			14.1		dBm
Output Third-Order Intercept	Δf = 1 MHz, output power (P _{OUT}) = −7 dBm per tone		30.0		dBm
Noise Figure			3.7		dB
FREQUENCY = 3500 MHz					
Gain		15.2	15.6	16.1	dB
vs. Frequency	±50 MHz		±0.05		dB
vs. Temperature	−40°C ≤ T _A ≤ +85°C		±0.4		dB
vs. Supply	4.75 V to 5.25 V		±0.03		dB
Output 1 dB Compression Point			12.2		dBm
Output Third-Order Intercept	Δf = 1 MHz, output power (P _{OUT}) = −7 dBm per tone		26.0		dBm
Noise Figure			4.1		dB
FREQUENCY = 4000 MHz					
Gain		14.4	15.0	15.5	dB
vs. Frequency	±50 MHz		±0.10		dB
vs. Temperature	−40°C ≤ T _A ≤ +85°C		±0.6		dB
vs. Supply	4.75 V to 5.25 V		±0.08		dB
Output 1 dB Compression Point			10.8		dBm
Output Third-Order Intercept	Δf = 1 MHz, output power (P _{OUT}) = −7 dBm per tone		23.8		dBm
Noise Figure			4.6		dB
FREQUENCY = 5000 MHz					
Gain			14.0		dB
vs. Frequency	±50 MHz		±0.04		dB
vs. Temperature	−40°C ≤ T _A ≤ +85°C		±0.6		dB
vs. Supply	4.75 V to 5.25 V		±0.10		dB
Output 1 dB Compression Point			8.7		dBm
Output Third-Order Intercept	Δf = 1 MHz, output power (P _{OUT}) = −7 dBm per tone		21.3		dBm
Noise Figure			4.8		dB
FREQUENCY = 5800 MHz					
Gain			14.5		dB
vs. Frequency	±50 MHz		±0.15		dB
vs. Temperature	−40°C ≤ T _A ≤ +85°C		±1.0		dB
vs. Supply	4.75 V to 5.25 V		±0.10		dB
Output 1 dB Compression Point			7.0		dBm
Output Third-Order Intercept	Δf = 1 MHz, output power (P _{OUT}) = −7 dBm per tone		18.7		dBm
Noise Figure			5.4		dB
POWER INTERFACE					
Supply Voltage	V _{POS}	4.75	5	5.25	V
Supply Current			55	69	mA
vs. Temperature	−40°C ≤ T _A ≤ +85°C		−5		mA
Power Dissipation	V _{POS} = 5 V		275		mW

TYPICAL SCATTERING PARAMETERS (S-PARAMETERS)

$V_{POS} = 5\text{ V}$ and $T_A = 25^\circ\text{C}$. The effects of the test fixture have been deembedded up to the pins of the device.

Table 2.

Frequency (MHz)	S11		S21		S12		S22	
	Magnitude (dB)	Angle (°)	Magnitude (dB)	Angle (°)	Magnitude (dB)	Angle (°)	Magnitude (dB)	Angle (°)
30	-9.75838	-92.0495	19.91469	160.691	-21.4134	19.08688	-10.175	-100.818
50	-13.0161	-114.478	18.9406	163.9441	-21.1763	10.75632	-12.7436	-124.228
100	-15.8296	-142.951	18.34431	167.4073	-21.0719	3.454046	-14.8272	-150.688
200	-16.7468	-164.185	18.13374	166.5362	-21.059	-2.10036	-15.7366	-169.056
300	-16.7917	-173.294	18.0488	163.4408	-21.0741	-5.56114	-15.9476	-177.5
400	-16.7639	-178.57	17.97824	159.7115	-21.0901	-8.54887	-15.9985	177.0591
500	-16.6368	176.8142	17.91669	155.6494	-21.1284	-11.3218	-15.9997	172.8508
600	-16.5495	172.727	17.85356	151.5874	-21.1641	-13.9309	-15.9194	169.301
700	-16.4931	169.7664	17.77106	147.4093	-21.2044	-16.5131	-15.8227	166.4768
800	-16.4227	166.4253	17.71131	143.3218	-21.2438	-19.0298	-15.7257	163.7476
900	-16.3553	163.4457	17.66826	139.1424	-21.2871	-21.5022	-15.5947	162.0291
1000	-16.4799	160.784	17.58888	134.9062	-21.3302	-23.9656	-15.6619	160.4644
1100	-16.4953	158.6829	17.53756	130.7521	-21.3803	-26.4082	-15.644	159.4497
1200	-16.7606	157.8074	17.47488	126.5829	-21.4161	-28.8192	-15.8311	159.6244
1300	-16.9103	157.3382	17.44318	122.3575	-21.4674	-31.2788	-15.9907	159.7403
1400	-17.2225	158.2929	17.38821	118.1946	-21.5203	-33.7399	-16.21	160.9107
1500	-17.6402	160.1629	17.33858	114.0765	-21.5672	-36.1081	-16.539	162.8989
1600	-18.0653	164.333	17.32871	109.7247	-21.6024	-38.6986	-16.7579	165.3782
1700	-18.5601	169.5526	17.27848	105.5495	-21.6825	-41.0309	-17.0431	169.2425
1800	-19.01	177.6071	17.22524	101.4425	-21.7323	-43.4108	-17.1957	174.945
1900	-19.1982	-173.627	17.19407	97.28532	-21.7873	-45.7867	-17.2297	-179.104
2000	-19.156	-163.672	17.14779	93.09047	-21.8417	-48.1855	-17.0968	-171.974
2100	-18.7447	-154.484	17.1201	88.86399	-21.8994	-50.5584	-16.8241	-164.872
2200	-18.2725	-146.868	17.06239	84.78041	-21.9604	-52.8879	-16.481	-158.228
2300	-17.5769	-140.357	17.00071	80.71247	-22.0229	-55.1919	-16.0694	-152.253
2400	-16.9363	-136.067	16.97464	76.65373	-22.0831	-57.4478	-15.6966	-147.411
2500	-16.3707	-133.128	16.91632	72.6253	-22.1477	-59.6933	-15.4361	-143.919
2600	-15.8425	-131.025	16.84092	68.6308	-22.2125	-61.938	-15.2228	-141.803
2700	-15.4474	-130.097	16.80102	64.69363	-22.2782	-64.111	-15.209	-141.248
2800	-15.1642	-129.731	16.74106	60.74876	-22.3485	-66.3047	-15.2585	-142.511
2900	-14.9231	-130.057	16.68572	56.76032	-22.4164	-68.5093	-15.3514	-145.642
3000	-14.8791	-130.912	16.64527	52.71256	-22.4858	-70.6726	-15.4628	-150.396
3100	-14.8847	-132.738	16.56622	48.69909	-22.5616	-72.9343	-15.4514	-156.986
3200	-14.9364	-134.966	16.51404	44.62054	-22.636	-75.1868	-15.2627	-164.185
3300	-15.1065	-138.423	16.45702	40.56141	-22.7184	-77.4701	-14.9704	-171.492
3400	-15.2148	-142.265	16.38871	36.48298	-22.8123	-79.8304	-14.4379	-178.173
3500	-15.2414	-147.094	16.3331	32.32549	-22.9021	-82.0942	-13.8431	175.3551
3600	-15.0937	-152.434	16.26873	28.0511	-23.0024	-84.4293	-13.2863	169.8835
3700	-14.8339	-157.56	16.2039	23.84273	-23.1015	-86.7756	-12.7034	164.8455
3800	-14.3558	-162.074	16.11548	19.63339	-23.2085	-89.1254	-12.1263	160.5459
3900	-13.7757	-166.117	16.03442	15.32869	-23.3318	-91.426	-11.5679	156.6935
4000	-13.0504	-169.18	15.92646	11.18556	-23.4494	-93.8454	-10.9616	153.5414
4100	-12.3247	-171.219	15.82941	6.975896	-23.577	-96.1196	-10.3638	151.0243
4200	-11.6347	-173.249	15.72571	2.726895	-23.7138	-98.3778	-9.78722	149.3781
4300	-10.9654	-174.775	15.58441	-1.36477	-23.8541	-100.612	-9.23037	148.452
4440	-10.2422	-176.69	15.44684	-7.08335	-24.0446	-103.673	-8.61459	148.1682
4500	-9.95152	-177.613	15.38641	-9.50947	-24.1234	-104.95	-8.40319	148.3894
4600	-9.51739	-178.831	15.2557	-13.503	-24.2418	-107.053	-8.1407	148.9119

Frequency (MHz)	S11		S21		S12		S22	
	Magnitude (dB)	Angle (°)	Magnitude (dB)	Angle (°)	Magnitude (dB)	Angle (°)	Magnitude (dB)	Angle (°)
4700	-9.15961	179.4184	15.18857	-17.5037	-24.3599	-109.077	-8.00124	149.4702
4800	-8.81402	177.4327	15.08704	-21.4903	-24.4618	-111.079	-7.96813	149.7089
4900	-8.53104	175.2276	14.98061	-25.462	-24.5534	-113.068	-8.06461	149.4032
5000	-8.30896	172.6355	14.92996	-29.3613	-24.6449	-114.946	-8.27561	148.5568
5100	-8.09121	170.0194	14.84603	-33.2282	-24.7131	-116.819	-8.51734	146.6025
5200	-7.92674	167.1306	14.7721	-37.1236	-24.7652	-118.67	-8.77718	143.5944
5300	-7.79364	163.9153	14.72301	-41.0236	-24.8151	-120.546	-8.99346	139.518
5400	-7.6793	160.6589	14.64549	-45.0881	-24.8399	-122.534	-9.12197	134.7305
5500	-7.61523	156.9392	14.59131	-49.1815	-24.8628	-124.569	-9.17338	129.7103
5600	-7.60815	152.7976	14.53579	-53.2876	-24.8758	-126.604	-9.15423	124.593
5700	-7.54914	148.5617	14.47484	-57.5187	-24.8597	-128.793	-9.05211	119.5068
5800	-7.51209	143.7768	14.45495	-61.7253	-24.8296	-131.021	-9.00726	114.4158
5900	-7.46152	138.6641	14.42222	-66.0417	-24.7902	-133.375	-9.00598	109.1347
6000	-7.35914	133.6743	14.38015	-70.439	-24.7398	-135.849	-9.00546	103.4141

ABSOLUTE MAXIMUM RATINGS

Table 3.

Parameter	Rating
Supply Voltage, V_{POS}	6.5 V
Input Power (50 Ω Impedance)	18 dBm
Internal Power Dissipation (Pad Soldered to Ground)	400 mW
Maximum Junction Temperature	150°C
Operating Temperature Range	–40°C to +105°C
Storage Temperature Range	–65°C to +150°C

Stresses above those listed under Absolute Maximum Ratings may cause permanent damage to the device. This is a stress rating only; functional operation of the device at these or any other conditions above those indicated in the operational section of this specification is not implied. Exposure to absolute maximum rating conditions for extended periods may affect device reliability.

THERMAL RESISTANCE

Table 4 lists the junction-to-air thermal resistance (θ_{JA}) and the junction-to-case thermal resistance (θ_{JC}) for the ADL5544.

Table 4. Thermal Resistance

Package Type	θ_{JA} ¹	θ_{JC} ²	Unit
3-Lead SOT-89 (RK-3)	53	15	°C/W

¹ Measured on the ADL5544 evaluation board. For more information about board layout, see the Soldering Information and Recommended PCB Land Pattern section.

² Based on simulation with a standard JEDEC board per JESD51.

ESD CAUTION



ESD (electrostatic discharge) sensitive device. Charged devices and circuit boards can discharge without detection. Although this product features patented or proprietary protection circuitry, damage may occur on devices subjected to high energy ESD. Therefore, proper ESD precautions should be taken to avoid performance degradation or loss of functionality.

PIN CONFIGURATION AND FUNCTION DESCRIPTIONS

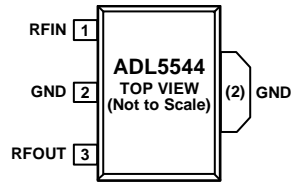

NOTES

1. THE EXPOSED PAD ENCOMPASSES PIN 2 AND THE TAB AT THE TOP SIDE OF THE PACKAGE. SOLDER THE EXPOSED PAD TO A LOW IMPEDANCE GROUND PLANE FOR ELECTRICAL GROUNDING AND THERMAL TRANSFER.

11384-002

Figure 2. Pin Configuration

Table 5. Pin Function Descriptions

Pin No.	Mnemonic	Description
1	RFIN	RF Input. This pin requires a dc blocking capacitor.
2	GND	Ground. Connect this pin to a low impedance ground plane.
3	RFOUT	RF Output and Supply Voltage. DC bias is provided to this pin through an inductor that is connected to the external power supply. The RF path requires a dc blocking capacitor.
	EPAD	Exposed Pad. The exposed pad encompasses Pin 2 and the tab at the top side of the package. Solder the exposed pad to a low impedance ground plane for electrical grounding and thermal transfer.

TYPICAL PERFORMANCE CHARACTERISTICS

500 MHz TO 4 GHz FREQUENCY BAND

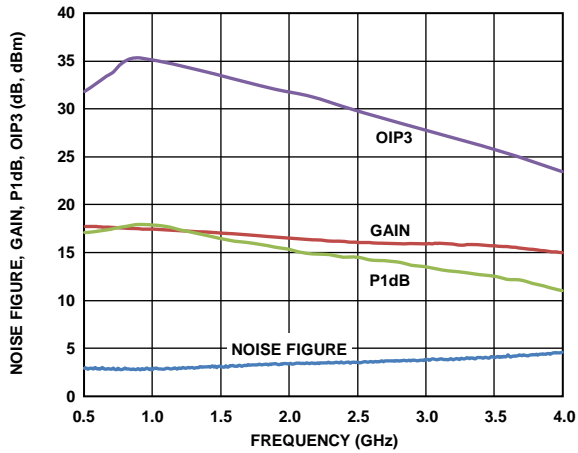

Figure 3. Noise Figure, Gain, P1dB, and OIP3 vs. Frequency

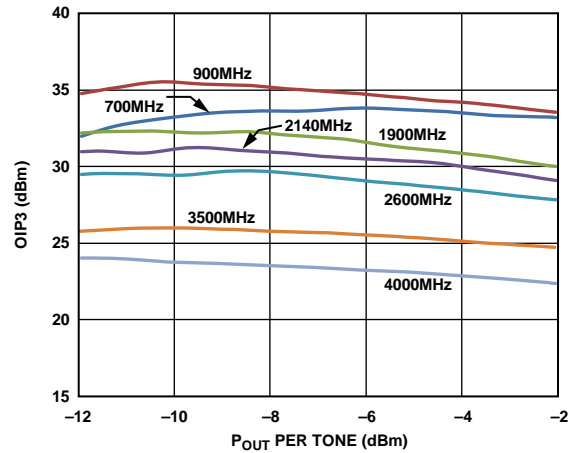

Figure 6. OIP3 vs. Output Power (P_{OUT}) and Frequency

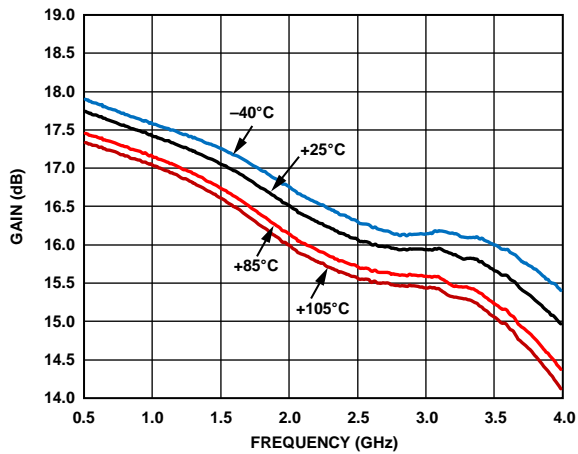

Figure 4. Gain vs. Frequency and Temperature

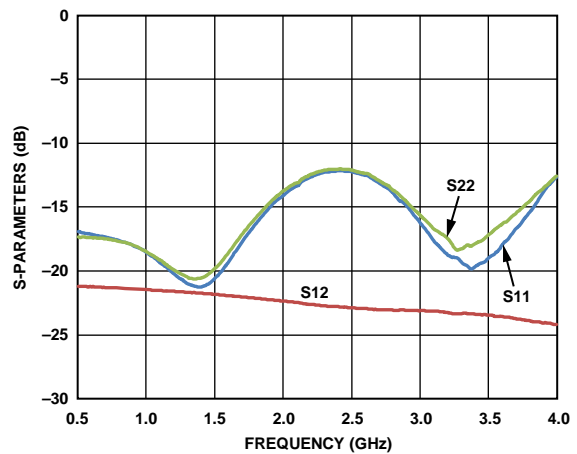

Figure 7. Input Return Loss (S_{11}), Output Return Loss (S_{22}), and Reverse Isolation (S_{12}) vs. Frequency

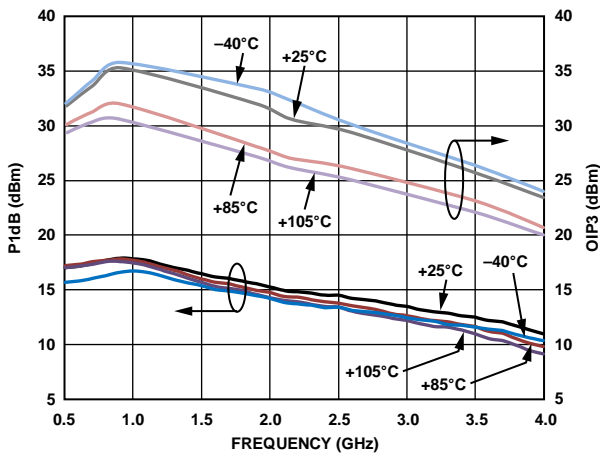

Figure 5. P1dB and OIP3 vs. Frequency and Temperature

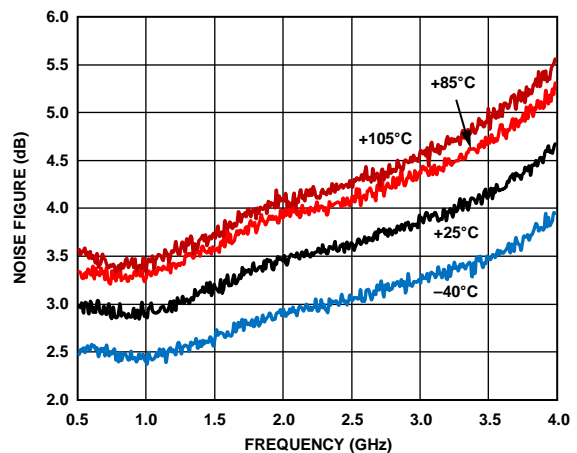

Figure 8. Noise Figure vs. Frequency and Temperature

100 MHz TO 500 MHz FREQUENCY BAND

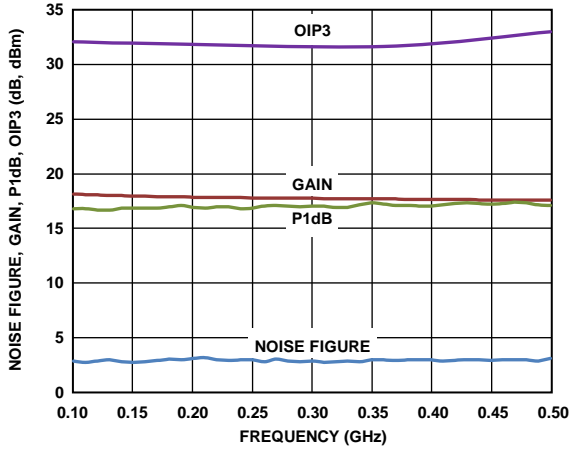

Figure 9. Noise Figure, Gain, P1dB, and OIP3 vs. Frequency, Low Frequency Configuration

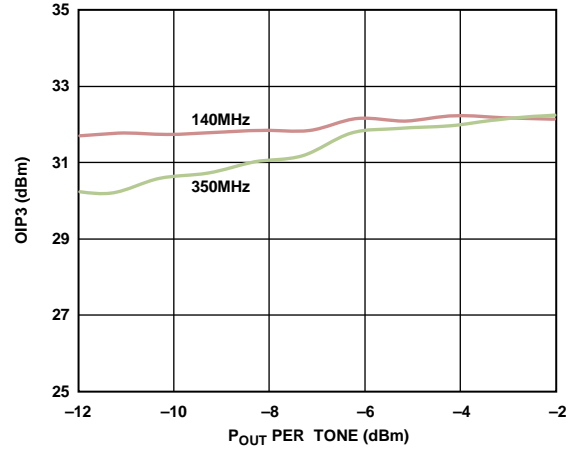

Figure 12. OIP3 vs. Output Power (P_{OUT}) and Frequency, Low Frequency Configuration

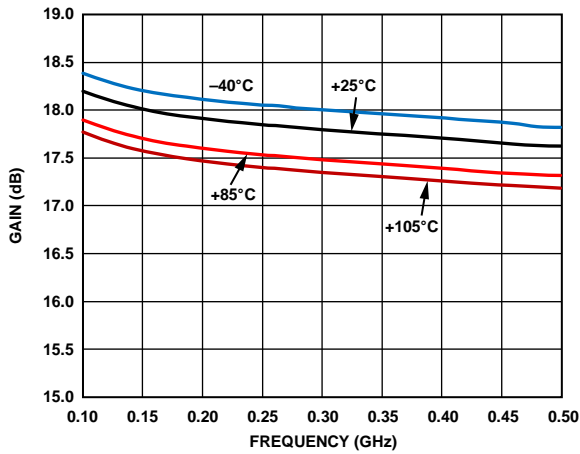

Figure 10. Gain vs. Frequency and Temperature, Low Frequency Configuration

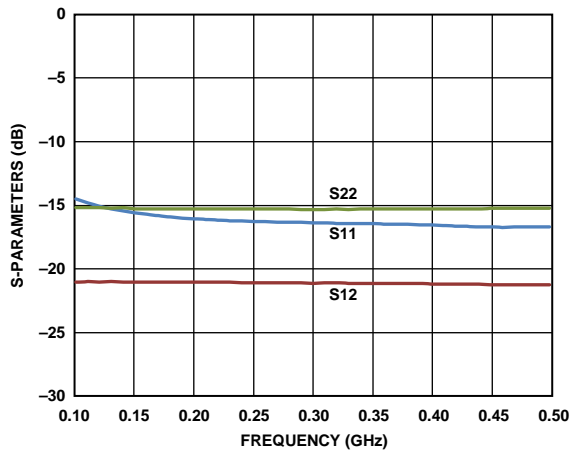

Figure 13. Input Return Loss (S11), Output Return Loss (S22), and Reverse Isolation (S12) vs. Frequency, Low Frequency Configuration

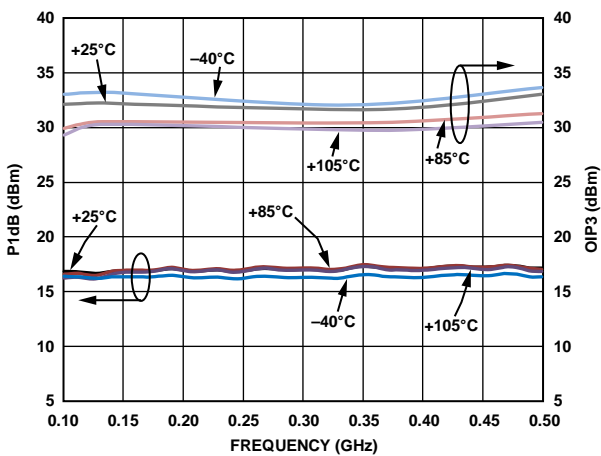

Figure 11. P1dB and OIP3 vs. Frequency and Temperature, Low Frequency Configuration

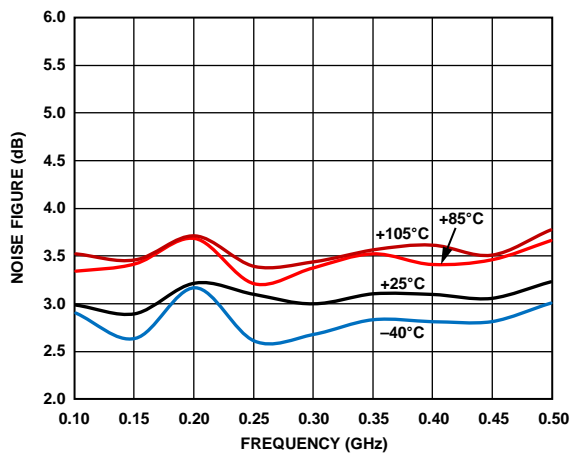

Figure 14. Noise Figure vs. Frequency and Temperature, Low Frequency Configuration

4 GHz TO 6 GHz FREQUENCY BAND

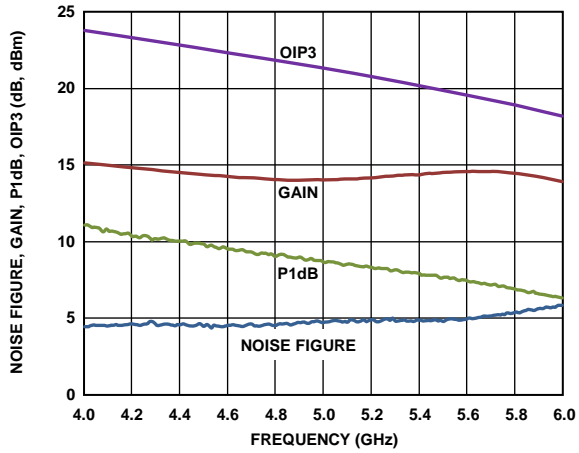

Figure 15. Noise Figure, Gain, P1dB, and OIP3 vs. Frequency, High Frequency Configuration

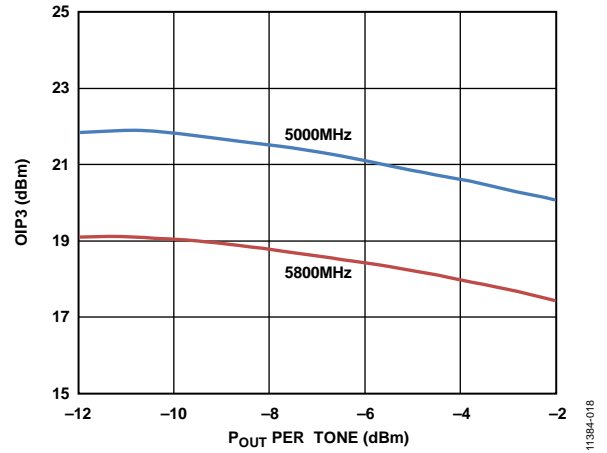

Figure 18. OIP3 vs. Output Power (P_{out}) and Frequency, High Frequency Configuration

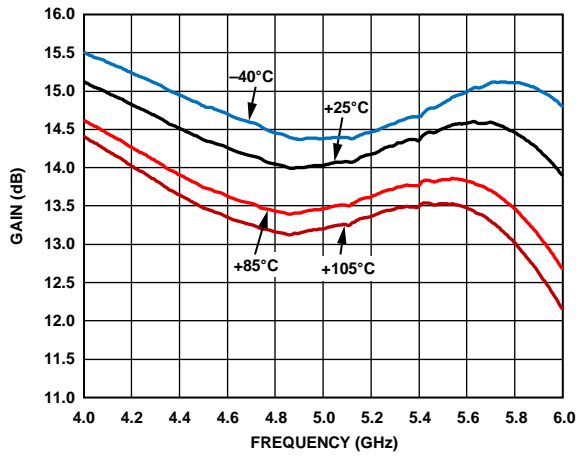

Figure 16. Gain vs. Frequency and Temperature, High Frequency Configuration

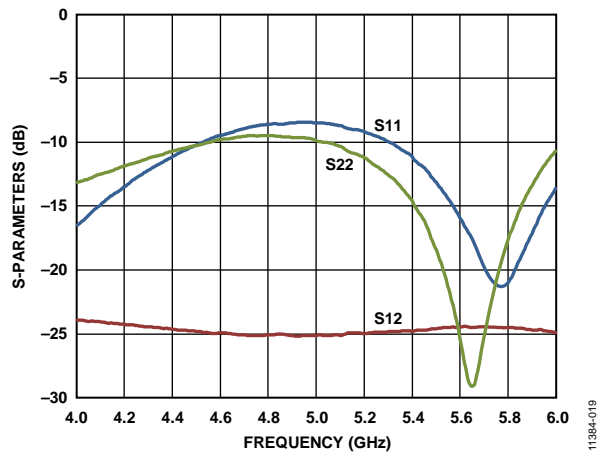

Figure 19. Input Return Loss (S_{11}), Output Return Loss (S_{22}), and Reverse Isolation (S_{12}) vs. Frequency, High Frequency Configuration

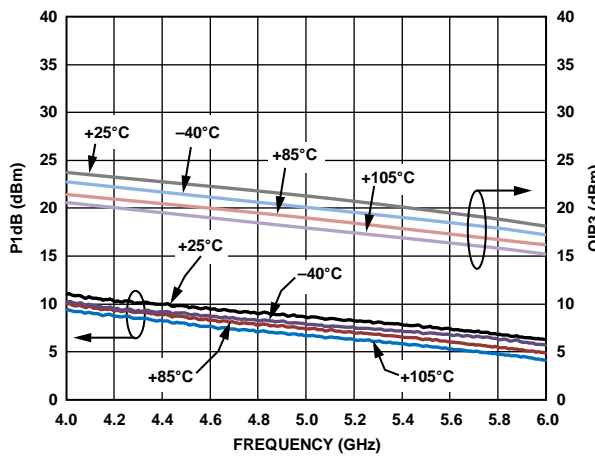

Figure 17. P1dB and OIP3 vs. Frequency and Temperature, High Frequency Configuration

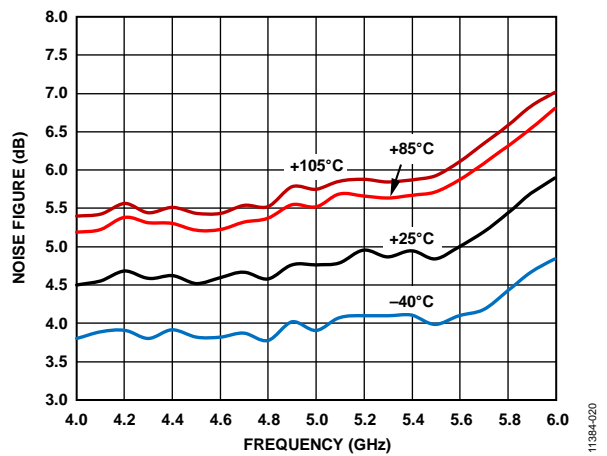

Figure 20. Noise Figure vs. Frequency and Temperature, High Frequency Configuration

GENERAL

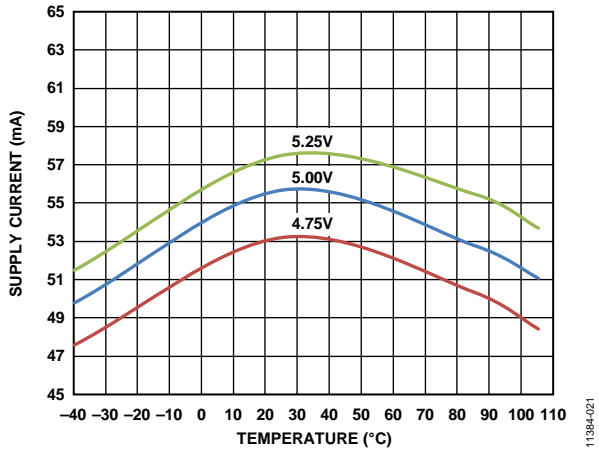

Figure 21. Supply Current vs. Temperature

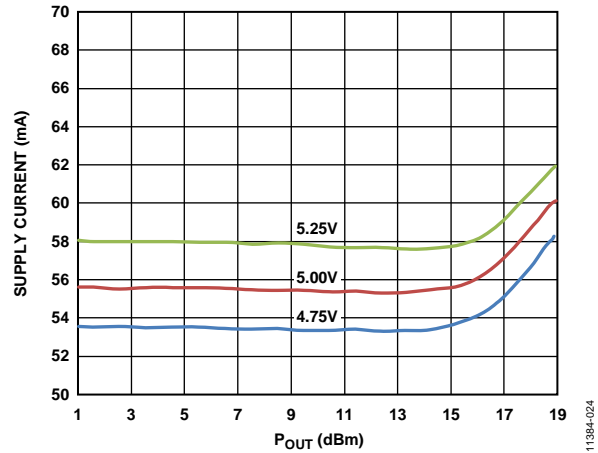

Figure 24. Supply Current vs. P_{OUT} at 900 MHz

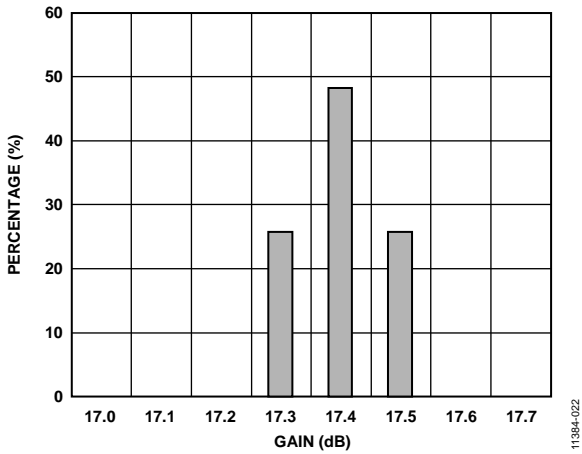

Figure 22. Gain Distribution at 900 MHz

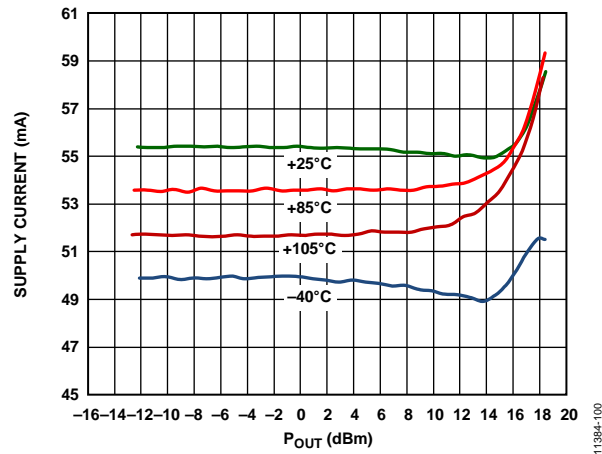

Figure 25. Supply Current vs. P_{OUT} and Temperature at 900 MHz

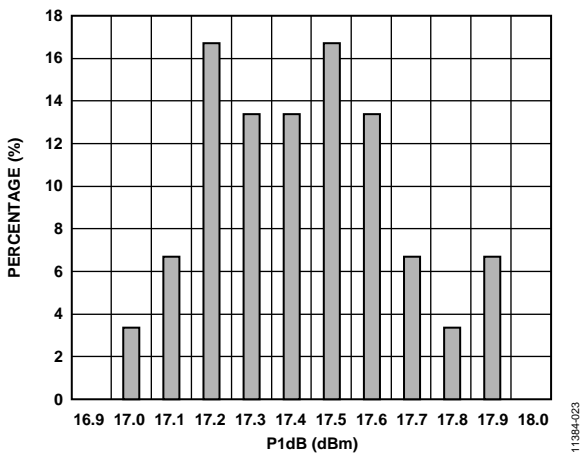

Figure 23. P_{1dB} Distribution at 900 MHz

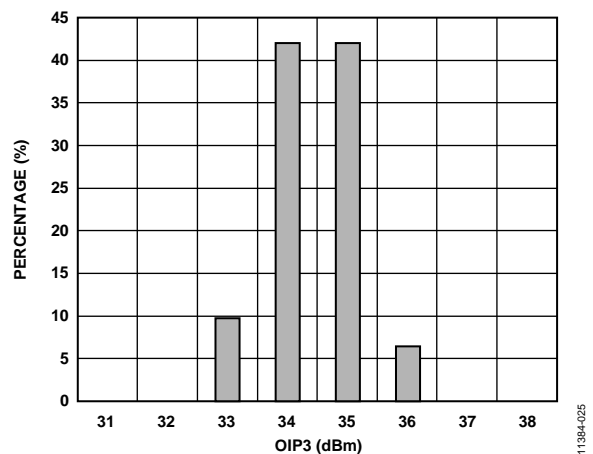

Figure 26. OIP₃ Distribution at 900 MHz, P_{OUT} = -7 dBm per Tone

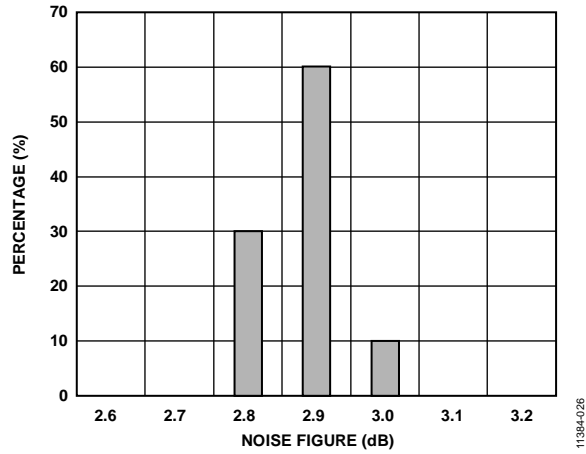

Figure 27. Noise Figure Distribution at 900 MHz

11384-026

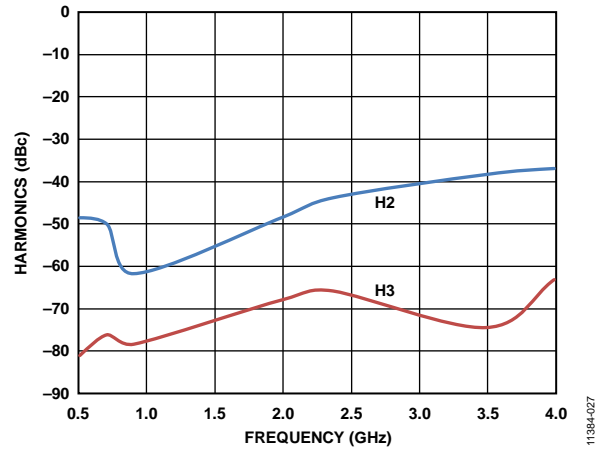

Figure 28. Single-Tone Harmonics vs. Frequency, $P_{OUT} = 0 \text{ dBm}$

11384-027

APPLICATIONS INFORMATION

BASIC CONNECTIONS

Figure 29 shows the basic connections for operating the ADL5544. The device supports operation from 30 MHz to 6 GHz. However, for optimal performance at lower and higher frequency bands, the board configuration must be adjusted. Table 6 lists the recommended board configuration to operate the device at various frequency bands.

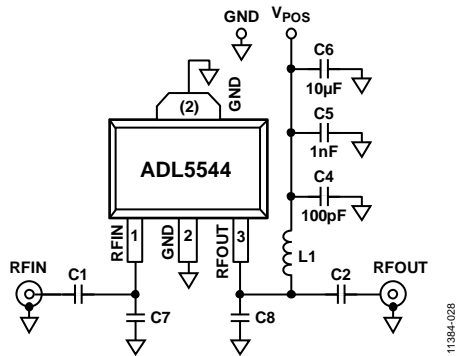

Figure 29. Basic Connections

A 5 V dc bias is supplied to the amplifier through the bias inductor connected to RFOUT (Pin 3). The bias voltage must be decoupled using 100 pF, 1 nF, and 10 μF power supply decoupling capacitors. The typical current consumption for the ADL5544 is 55 mA.

At low and high frequencies, the device exhibits improved performance with the suggested setup configuration listed in Table 6. Figure 30 to Figure 33 provide a comparison of the performance of the device at the 100 MHz to 500 MHz and 4 GHz to 6 GHz bands when driven with the optimal setup configuration and the default setup configuration.

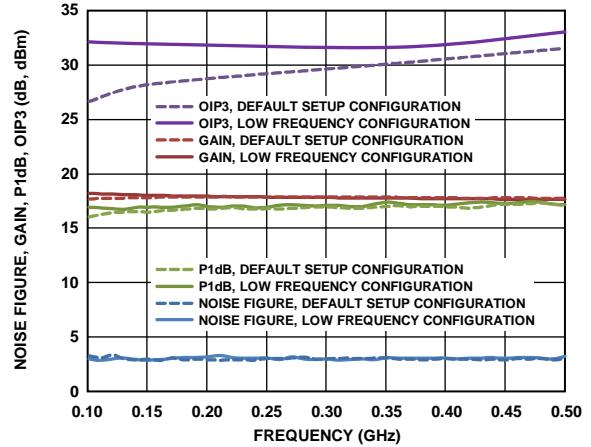

Figure 30. Noise Figure, Gain, P1dB, and OIP3 vs. Frequency, 100 MHz to 500 MHz, Comparison of Performance with the Optimized Settings and the Default Configuration

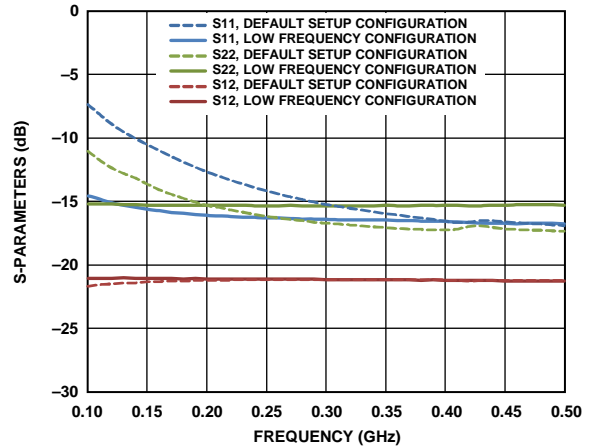

Figure 31. Return Loss and Reverse Isolation, 100 MHz to 500 MHz, Comparison of Performance with the Optimized Settings and the Default Configuration

Table 6. Recommended Components for Basic Connections

Frequency Band	AC Coupling Capacitors (0402)		DC Bias Inductor (0603HP)	High Frequency Matching Capacitors (0402)	
	C1	C2	L1	C7	C8
100 MHz to 500 MHz	100 nF	100 nF	1000 nH	Do not install	Do not install
500 MHz to 4 GHz (default)	100 pF	100 pF	100 nH	Do not install	Do not install
4 GHz to 6 GHz	100 pF	100 pF	12 nH	0.1 pF	0.1 pF

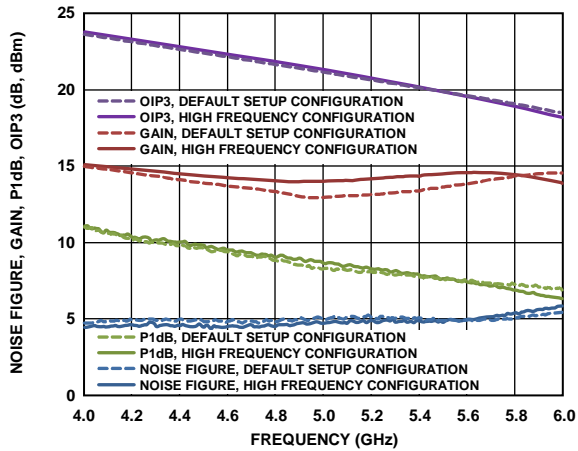

Figure 32. Noise Figure, Gain, P1dB, and OIP3 vs. Frequency, 4 GHz to 6 GHz, Comparison of Performance with the Optimized Settings and the Default Configuration

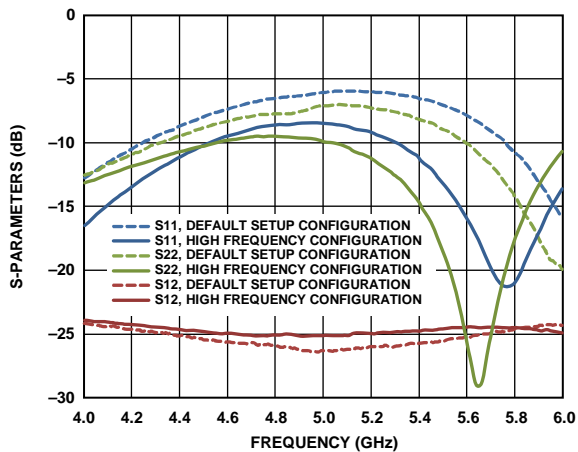

Figure 33. Return Loss and Reverse Isolation, 4 GHz to 6 GHz, Comparison of Performance with the Optimized Settings and the Default Configuration

SOLDERING INFORMATION AND RECOMMENDED PCB LAND PATTERN

Figure 34 shows the recommended land pattern for the ADL5544. To minimize thermal impedance, the exposed pad on the underside of the SOT-89 package is soldered to a ground plane, along with Pin 2. If multiple ground layers exist, stitch the layers together using vias.

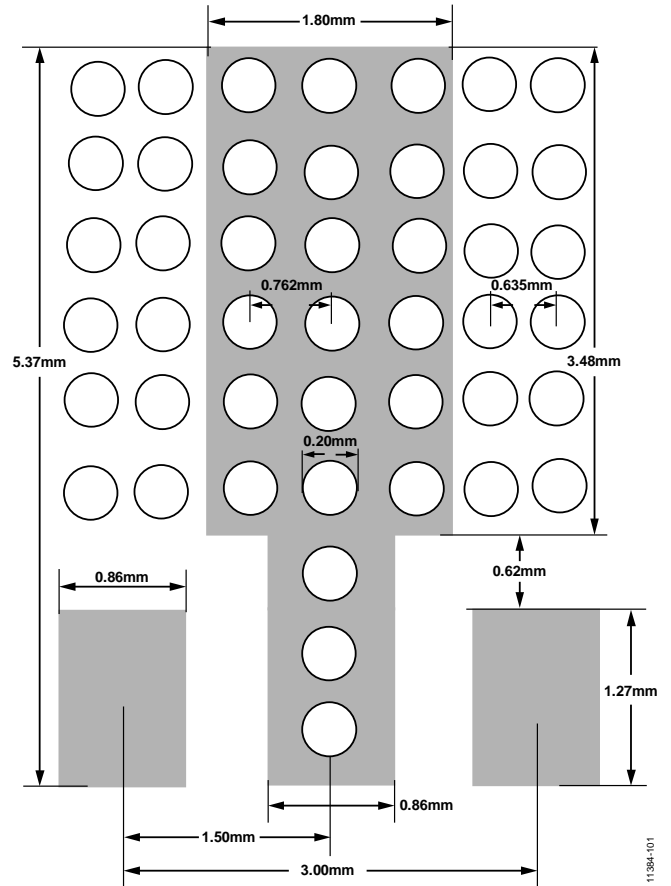

Figure 34. Recommended Land Pattern

The land pattern on the ADL5544 evaluation board provides a measured thermal resistance (θ_{JA}) of 53°C/W. To measure θ_{JA} , the temperature at the top of the SOT-89 package is found with an IR temperature gun. Thermal simulation suggests a junction temperature 10°C higher than the top-of-package temperature. With additional measurements of the ambient temperature and I/O power, θ_{JA} can be determined.

OPERATION DOWN TO 30 MHz

To operate the ADL5544 at frequencies below 100 MHz, a feedback network must be implemented between the input and output ports of the device to ensure stability. Figure 35 shows a sample configuration used to evaluate the device at frequencies below 100 MHz. Figure 36 to Figure 38 demonstrate the performance of the device in this configuration.

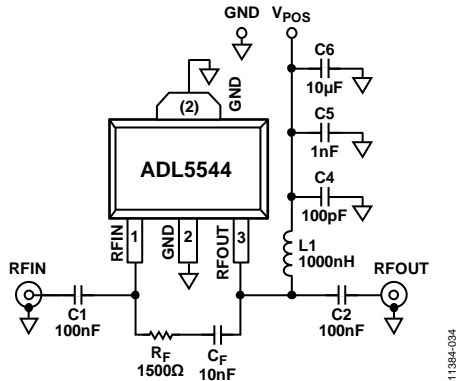

Figure 35. Setup for Low Frequency Operation Down to 30 MHz

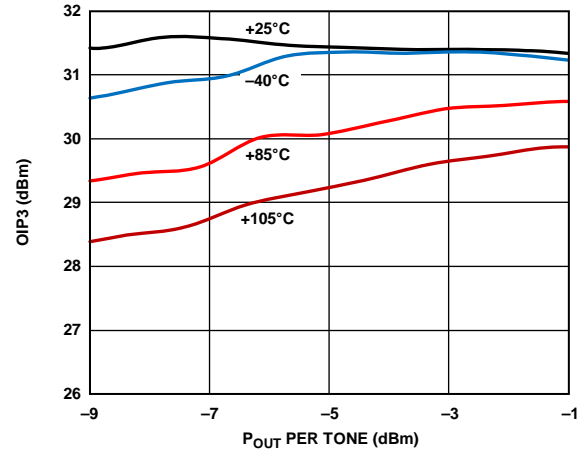

Figure 38. OIP3 vs. POUT at 30 MHz

W-CDMA ACPR PERFORMANCE

Figure 39 shows a plot of the adjacent channel power ratio (ACPR) vs. POUT for the ADL5544. The signal type used is a single wideband code division multiple access (W-CDMA) carrier (Test Model 1-64) at 2140 MHz. This signal is generated by a very low ACPR source. ACPR is measured at the output by a high dynamic range spectrum analyzer that incorporates an instrument noise-correction function.

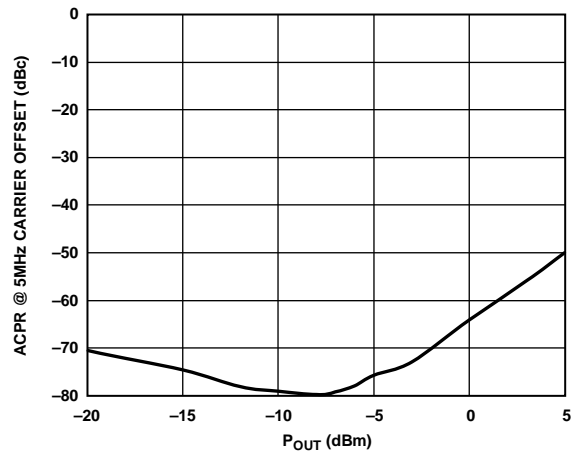

Figure 39. ACPR vs. POUT, Single W-CDMA Carrier (Test Model 1-64) at 2140 MHz

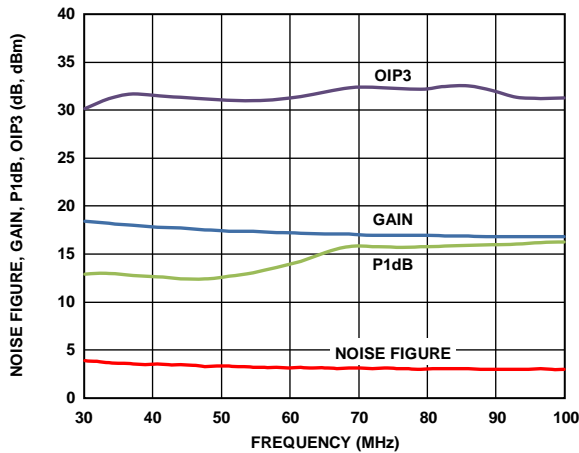

Figure 36. Noise Figure, Gain, P1dB, and OIP3 vs. Frequency, 30 MHz to 100 MHz

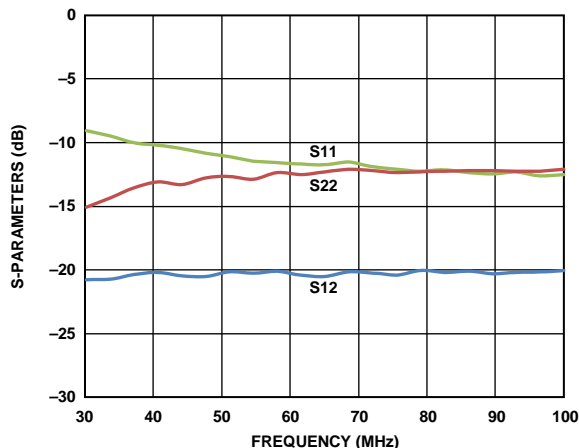

Figure 37. Return Loss and Reverse Isolation, 30 MHz to 100 MHz

The ADL5544 achieves an ACPR of -80 dBc at an output power level of -7 dBm, at which point device noise and not distortion begins to dominate the power in the adjacent channels. At an output power level of 0 dBm, ACPR is still very low at -63 dBc.

EVALUATION BOARD

Figure 40 shows the ADL5544 evaluation board layout. Figure 41 shows the schematic for the evaluation board. The board is powered by a single 5 V supply. Table 7 lists the components used on the evaluation board. Power can be applied to the board through clip-on leads (V_{SUP} , GND).

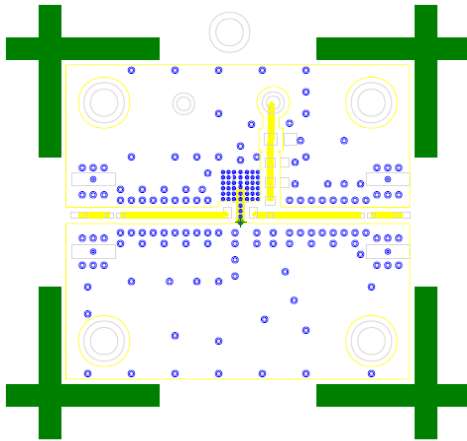

Figure 40. Evaluation Board Layout (Top)

11384-039

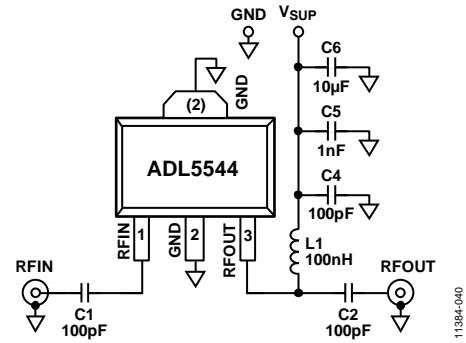

Figure 41. Evaluation Board Schematic

11384-040

Table 7. Evaluation Board Configuration Options

Component	Function	Default Value
C1, C2	AC coupling capacitors	100 pF, 0402
L1	DC bias inductor	100 nH, 0603 (Coilcraft 0603HP or equivalent)
V_{SUP} and GND	Clip-on terminals for power supply	
C4, C5, C6	Power supply decoupling capacitors	C4: 100 pF, 0603 C5: 1 nF, 0603 C6: 10 µF, 1206

OUTLINE DIMENSIONS

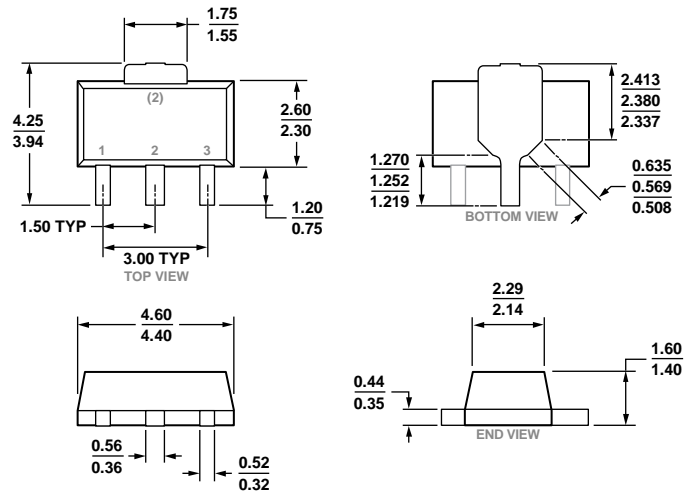

COMPLIANT TO JEDEC STANDARDS TO-243

Figure 42. 3-Lead Small Outline Transistor Package [SOT-89] (RK-3)

Dimensions shown in millimeters

ORDERING GUIDE

Model ¹	Temperature Range	Package Description	Package Option
ADL5544ARKZ-R7	-40°C to +105°C	3-Lead SOT-89, 7" Tape and Reel	RK-3
ADL5544-EVALZ	-40°C to +105°C	Evaluation Board	

¹ Z = RoHS Compliant Part.

NOTES

NOTES