

# SMD Inductors(Coils) For Power Line(Multilayer, Magnetic Shielded)

Conformity to RoHS Directive

## MLZ Series MLZ2012

The MLZ Series is a new line of laminated choke coils for decoupling with the industry's best DC superimposition characteristics and lowest DC resistance\*. TDK has developed this coil using its proprietary ferrite material technique and dense electrodes.

The MLZ Series exerts an excellent effect mainly on the decoupling of power circuits. It also exerts an effect on audio lines because of its low DC resistance.

The DC superimposition characteristics of the MLZ2012-W Series (IDC UP type) have been improved by up to 250% in comparison with those of other existing products. New addition of 22 and 47 $\mu$ H products has satisfied more needs: low through to high frequency ranges are supported.

\* The MLZ Series was regarded as having the industry's best DC superimposition characteristics and lowest DC resistance according to research conducted in February 2010.

### FEATURES

- The IDC UP type is a line of products with the industry's best DC superimposition characteristics.
- This product is now compatible with the E-6 series.
- Thanks to a broad inductance range (0.1 to 47 $\mu$ H), wide-ranging needs (from low through to high frequency ranges) can be satisfied.

### APPLICATIONS

Modules such as digital cellular phone and camera module, Netbooks, note PCs, DSCs, DVCs, video games, portable memory audio devices, navigation systems, PNDs, TVs, W-LANs, solid state drives

### SPECIFICATIONS

Operating temperature range	-55 to +125°C
Storage temperature range	-55 to +125°C

### RECOMMENDED SOLDERING CONDITION REFLOW SOLDERING

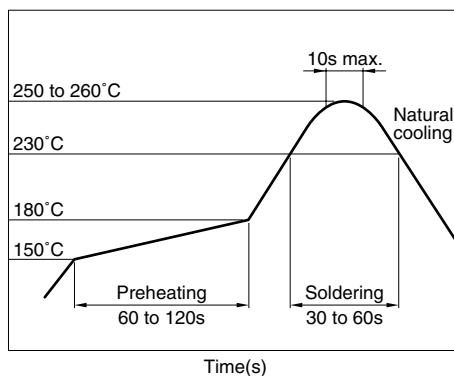

- Conformity to RoHS Directive: This means that, in conformity with EU Directive 2002/95/EC, lead, cadmium, mercury, hexavalent chromium, and specific bromine-based flame retardants, PBB and PBDE, have not been used, except for exempted applications.

- Please contact our Sales office when your application are considered the following:  
The device's failure or malfunction may directly endanger human life (e.g. application for automobile/aircraft/medical/nuclear power devices, etc.)

- All specifications are subject to change without notice.

### PRODUCT IDENTIFICATION

MLZ	2012	A	1R0	M	T
(1)	(2)	(3)	(4)	(5)	(6)

(1) Series name

(2) Dimensions L×W

2012	2.0×1.25mm
------	------------

(3) Material code

(4) Inductance value

R10	0.1 $\mu$ H
1R0	1.0 $\mu$ H
100	10.0 $\mu$ H

(5) Management symbol

D	High frequency supported
M	STD
W	IDC-UP

(6) Packaging style

T	Taping [reel]
---	---------------

### PACKAGING STYLE AND QUANTITIES

Packaging style	Thickness T(mm)	Quantity
Taping	0.85	4000 pieces/reel
	1.25	2000 pieces/reel

### HANDLING AND PRECAUTIONS

- Before soldering, be sure to preheat components.  
The preheating temperature should be set so that the temperature difference between the solder temperature and product temperature does not exceed 150°C.
- After mounting components onto the printed circuit board, do not apply stress through board bending or mishandling.
- The inductance value may change due to magnetic saturation if the current exceeds the rated maximum.
- Do not expose the inductors to stray magnetic fields.
- Avoid static electricity discharge during handling.
- When hand soldering, apply the soldering iron to the printed circuit board only. Temperature of the iron tip should not exceed 350°C. Soldering time should not exceed 3 seconds.

## SHAPES AND DIMENSIONS/RECOMMENDED PC BOARD PATTERN

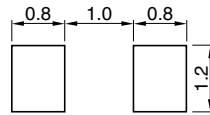
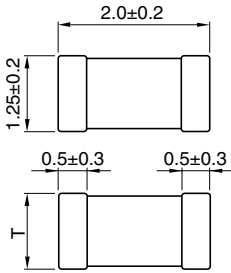

Dimensions in mm

T(Thickness)	Weight(mg)
0.85±0.2	10
1.25±0.2	14

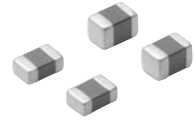

## ELECTRICAL CHARACTERISTICS

Classification	Part No.	Inductance (µH)	Inductance tolerance	Thickness (mm)	Test frequency L (MHz)	Test current L (mA)	Self-resonant frequency (MHz)typ.	DC resistance (Ω)±30%	Rated current*1 (mA)	Rated current*2 (mA)
High frequency supported	MLZ2012DR10DT	0.10	±20%	0.85	25	1.0	500	0.07	1000	1150
	MLZ2012DR22DT	0.22	±20%	0.85	25	1.0	330	0.13	800	900
	MLZ2012DR47DT	0.47	±20%	1.25	25	1.0	230	0.18	550	700
STD	MLZ2012A1R0MT	1.00	±20%	0.85	10	1.0	160	0.12	220	600
	MLZ2012A2R2MT	2.20	±20%	0.85	10	1.0	120	0.20	160	500
	MLZ2012E4R7MT	4.70	±20%	0.85	2	0.1	70	0.30	80	400
	MLZ2012E100MT	10.0	±20%	1.25	2	0.1	50	0.40	60	300
	MLZ2012A1R0WT	1.00	±20%	0.85	10	1.0	160	0.10	280	900
	MLZ2012A1R5WT	1.50	±20%	0.85	10	1.0	140	0.13	250	800
IDC-UP	MLZ2012A2R2WT	2.20	±20%	0.85	10	1.0	120	0.15	210	700
	MLZ2012A3R3WT	3.30	±20%	0.85	10	1.0	90	0.34	200	600
	MLZ2012M4R7WT	4.70	±20%	0.85	2	0.1	70	0.30	180	500
	MLZ2012M6R8WT	6.80	±20%	1.25	2	0.1	60	0.40	160	450
	MLZ2012M100WT	10.0	±20%	1.25	2	0.1	50	0.47	150	400
	MLZ2012M150WT	15.0	±20%	1.25	2	0.1	40	0.95	120	350
	MLZ2012M220WT	22.0	±20%	1.25	2	0.1	35	2.00	60	220
	MLZ2012M330WT	33.0	±20%	1.25	2	0.1	28	2.60	55	190
MLZ2012M470WT	47.0	±20%	1.25	2	0.1	20	3.70	50	170	

\*1 Rated Current Based on Inductance Variation: Current when inductance decreases by 50% of the initial value due to direct current superimposed characteristics

\*2 Rated Current Based on Increasing Product Temperature: Current when temperature of the product reaches +20°C

• Test equipment

Inductance: Ag4294A-16034G

### TYPICAL ELECTRICAL CHARACTERISTICS

#### INDUCTANCE vs. FREQUENCY CHARACTERISTICS

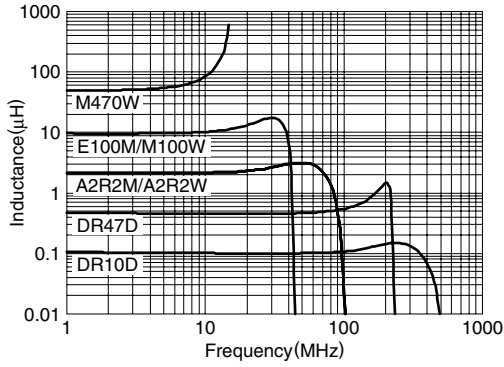

#### IMPEDANCE vs. FREQUENCY CHARACTERISTICS

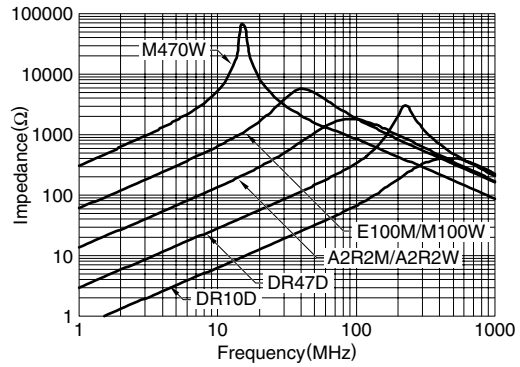

#### INDUCTANCE CHANGE vs. DC SUPERPOSITION CHARACTERISTICS

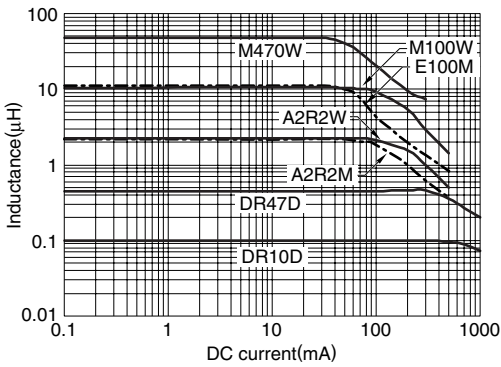

#### TEMPERATURE CHARACTERISTICS

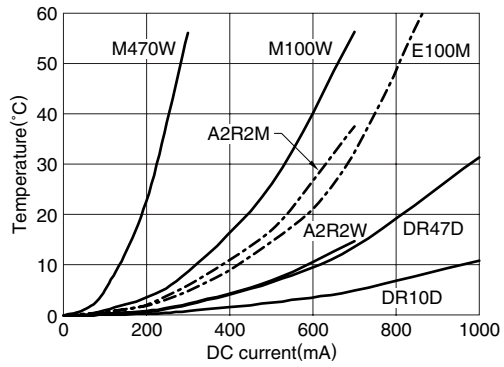

### PACKAGING STYLES

#### REEL DIMENSIONS

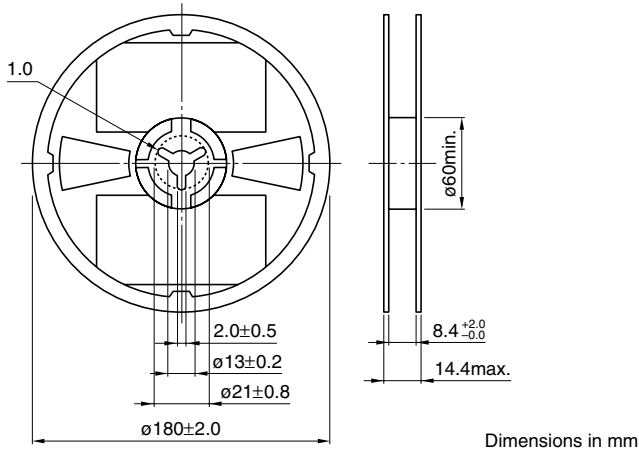

#### TAPE DIMENSIONS

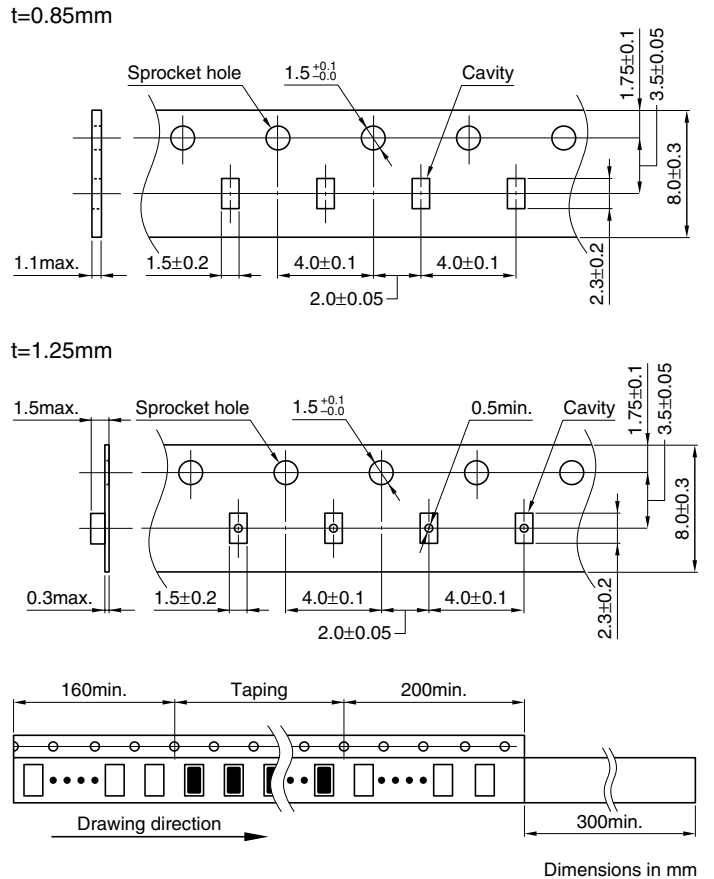

• All specifications are subject to change without notice.