

Pressure Sensor

PS/PF series

**⚠ Some product numbers are deprecated.
Not recommended for new design.**



PS Pressure sensor

PF Pressure sensor

High precision pressure sensor (without amp.)

Feature

- Compact size (PS type)
- High accuracy and liner characteristic
- Broad line-up
- RoHS compliant

Typical applications

- Industrial use : Pressure switches and pneumatic components, compressed air pressure measuring devices and airbeds
- Medical use : Airbeds
- Others : Pressure sensing devices for air pressure mediums

Ordering information

ADP

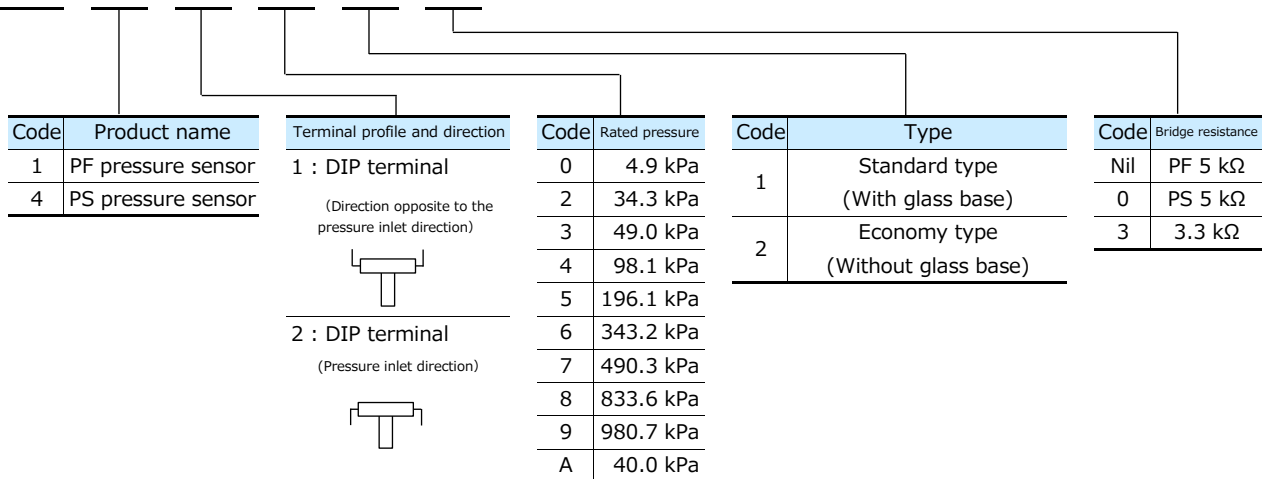

Types

Not Recommended for New Design

Standard packing : Carton : 100 pcs.; Case : 1,000 pcs.

Pressure	Brige resistance	Part No.									
		PS pressure sensor					PF pressure sensor				
		5 kΩ		3.3 kΩ			5 kΩ		3.3 kΩ		
	Terminal										
Standard type (with glass base)											
4.9 kPa		ADP41010	ADP42010	—	—	—	ADP1101	ADP1201	—	—	
34.3 kPa		ADP41210	ADP42210	—	—	—	ADP1121	ADP1221	—	—	
49.0 kPa		ADP41310	ADP42310	—	—	—	ADP1131	ADP1231	—	—	
98.1 kPa		ADP41410	ADP42410	ADP4932	ADP41413	ADP42413	ADP1141	ADP1241	—	—	
196.1 kPa		ADP41510	ADP42510	—	—	—	ADP1151	ADP1251	—	—	
343.2 kPa		ADP41610	ADP42610	—	—	—	ADP1161	ADP1261	—	—	
490.3 kPa		ADP41710	ADP42710	—	—	—	ADP1171	ADP1271	—	—	
833.6 kPa		ADP41810	ADP42810	—	—	—	ADP1181	ADP1281	—	—	
980.7 kPa		ADP41910	ADP42910	ADP4933	ADP41913	ADP42913	ADP1191	ADP1291	—	—	
Economy type (without glass base)											
40.0 kPa		—	—	—	ADP41A23	ADP42A23	—	—	ADP11A23	ADP12A23	

Design and specifications are each subject to change without notice. Ask factory for the current technical specifications before purchase and/or use. Should a safety concern arise regarding this product, please be sure to contact us immediately.

Rating										
Type	Standard type (With glass base)								Economy type (Without glass base)	
Type of pressure	Gauge pressure									
Pressure medium	Air ^{*1}									
Rated pressure (kPa)	4.9 to 49.0	98.1,196.1	343.2	490.3	833.6	980.7	98.1 ^{*2}	980.7 ^{*2}	40.0	
Max. applied pressure	Twice of the rated pressure				1.5 times of the rated pressure		Twice of the rated pressure	1.5 times of the rated pressure	Twice of the rated pressure	
Bridge resistance	5,000 Ω ± 1,000 Ω					3,300 Ω ± 700 Ω			3,300 Ω ± 600 Ω	
Ambient temperature	-20 °C to +100 °C -4 °F to +212 °F (no freezing or condensation)								-5 °C to +50 °C 23 °F to +122 °F	
Storage temperature	-40 °C to +120 °C -40 °F to +248 °F (no freezing or condensation)								-20 °C to +70 °C -4 °F to +158 °F	
Standard temperature	25 °C 77 °F					30 °C 86 °F			25 °C 77 °F	
Temperature compensation range	0 °C to 50 °C 32 °F to +122 °F					0 °C to 60 °C 32 °F to +140 °F			5 °C to 45 °C 41 °F to +113 °F	
Drive current (constant current)	1.5 mA					1.0 mA			1.5 mA	
Output span voltage	40 ± 20 mV	100 ± 40 mV				65 ± 25 mV			43.5 ± 22.5 mV	
Offset voltage	±20 mV									±15 mV
Linearity	±0.7 %FS	±0.3 %FS	±0.5 %FS	±0.6 %FS		±1.0 %FS			±0.3 %FS	
Pressure hysteresis	±0.6 %FS	±0.2 %FS	±0.4 %FS			±1.0 %FS			±0.7 %FS	
Offset voltage-temperature characteristics ^{*3}	±15 %FS	±5.0 %FS				±3.5 %FS			±10 %FS	
Sensitivity-temperature characteristics ^{*3}	±10 %FS	±2.5 %FS							±1.3 %FS	

*1: Please consult us if a pressure medium other than air is to be used.

Not recommended for new design

*2: For PS pressure sensor only

*3: This is the regulation which applies within the compensation temperature range.

◆ Unless otherwise specified, measurements were taken with a drive current of ±0.01 mA and humidity ranging from 25% to 85%.

◆ Please consult us if the intended use involves a negative pressure.

Reference data

[PS pressure sensor]

● Characteristics data

1.-(1) Output characteristics

ADP41913

Drive current : 1.0 mA

Temperature : 30 °C 86 °F

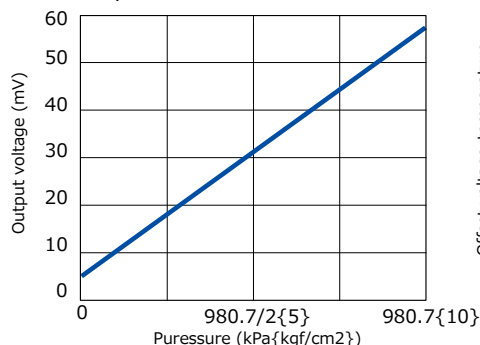

1.-(2) Offset voltage - temperature characteristics

ADP41913

Drive current : 1.0 mA

Rating : ±3.5 % FS

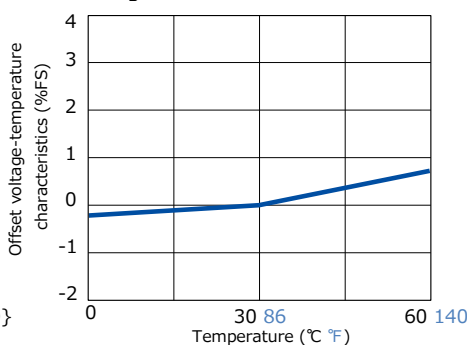

1.-(3) Sensitivity -temperature characteristics

ADP41913

Drive current : 1.0 mA

Rating : ±2.5 % FS

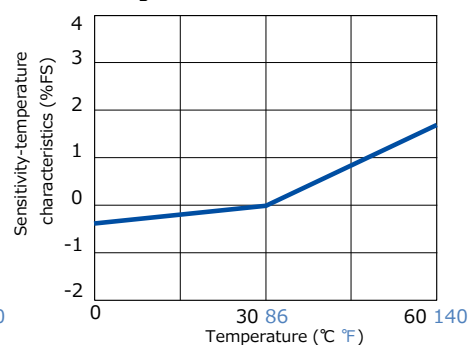

● Pressure cycle range (0 to rated pressure)

Tested sample : ADP41913, temperature : 100 °C 212 °F, No. of cycle: 1 × 10⁶

Offset voltage range

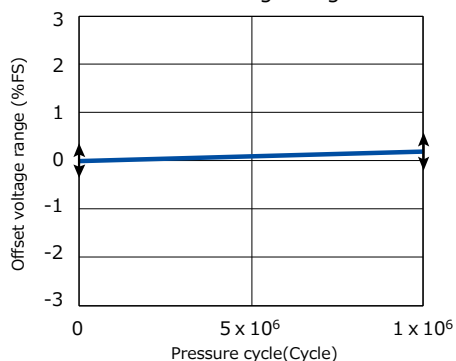

Output span voltage range

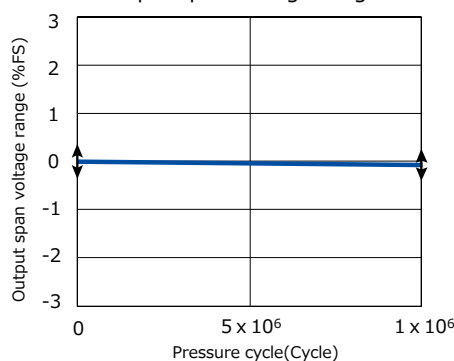

Even after testing for 1 million times, the variations in the offset voltage and output span voltage are minimal.

Reference data

[PF pressure sensor]

● Characteristics data

1. -① Output characteristics

ADP1141
Drive current : 1.5 mA
Temp. : 25 °C 77 °F

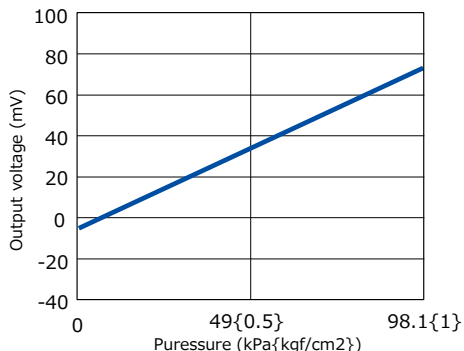

1. -② Offset voltage - temperature characteristics

ADP1141
Drive current : 1.5 mA
Rating : ±5 % FS

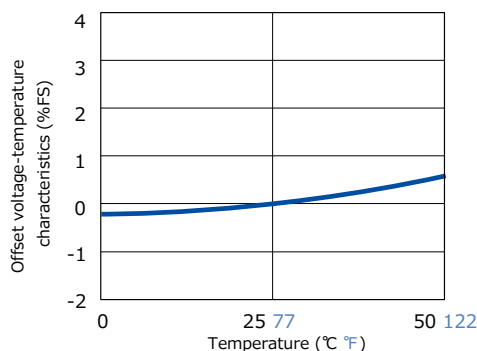

1. -③ Sensitivity - temperature characteristics

ADP1141
Drive current : 1.5 mA
Rating : ±2.5% FS

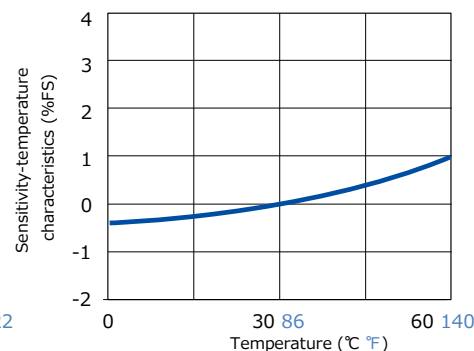

● Pressure cycle range (0 to rated pressure)

Tested sample : ADP1131, temperature : 25 °C 77 °F

Offset voltage range

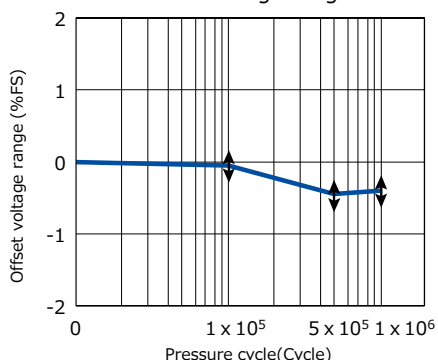

Output span voltage range

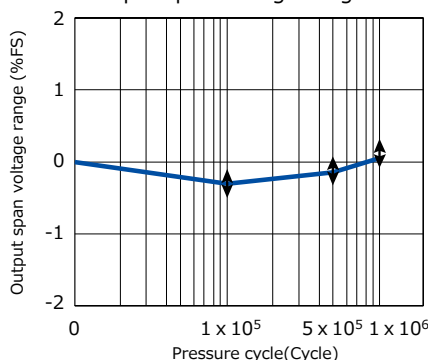

Evaluation test

Classification	Tested item	Tested condition	Result
Environmental characteristics	Storage at high temperature	Temperature : Left in a 120 °C 248 °F constant temperature bath Time : 1000 h	Passed
	Storage at low temperature	Temperature : Left in a -40 °C -40 °F constant temperature bath Time : 1000 h	Passed
	Humidity	Temperature/humidity : Left at 40 °C 104 °F, 90 % RH Time : 1000 h	Passed
	Temperature cycle	Temperature : -40 °C to 120 °C -40 °F to 248 °F 1 cycle : 30 Min. Times of cycle : 100	Passed
Endurance characteristics	High temperature/high humidity operation	Temperature/humidity : 40 °C 104 °F, 90% RH Operation times : 10 ⁶ , rated voltage applied.	Passed
Mechanical characteristics	Vibration resistance	Double amplitude : 1.5 mm 0.059 inch Vibration : 10 ~ 55 Hz Applied vibration direction : X, Y, Z 3 directions Time : 2 hrs each	Passed
	Dropping resistance	Dropping height : 75 cm Times : 2 times	Passed
	Terminal strength	Pulling strength : 9.8 N {1 kgf}, 10 sec. Bending strength : 4.9 N {0.5 kgf}, left and right 90 ° 1 time	Passed
Soldering characteristics	Solderability	Temperature : 230 °C 446 °F Time : 5 sec	Passed
	Heat resistance (DIP)	Temperature : 260 °C 500 °F Time : 10 sec	Passed

Note: For details other than listed above, please consult us.

Items	Criteria
Offset voltage	Variation amount
Output span voltage	within ±5.0 %FS of value

Dimensions

The CAD data of the products with a **CAD data** mark can be downloaded from: <http://industrial.panasonic.com/>

[PS pressure sensor]

- Terminal direction : DIP terminal Direction opposite to the pressure inlet direction ADP41□□□

CAD data

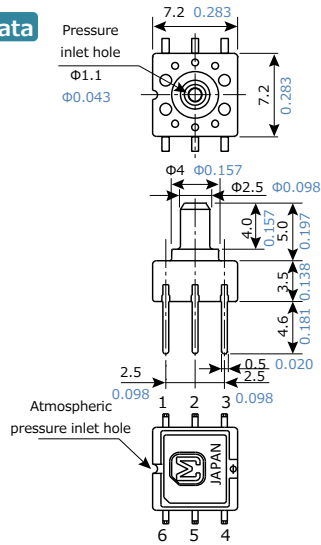

Recommended PC board pattern (BOTTOM VIEW)

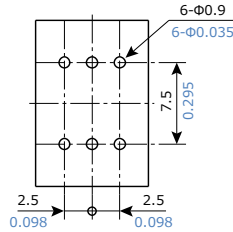

Terminal connection diagram

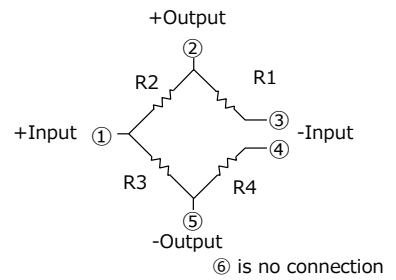

Terminal No.	Name
1	Power supply (+)
2	Output (+)
3	Power supply (-)
4	Power supply (-)
5	Output (-)
6	NC (No connection)

Note: Leave terminal 6 unconnected.

Unit : mm inch, General tolerance $\pm 0.3 \pm 0.012$

- Terminal direction : DIP terminal Pressure inlet direction ADP42□□□

CAD data

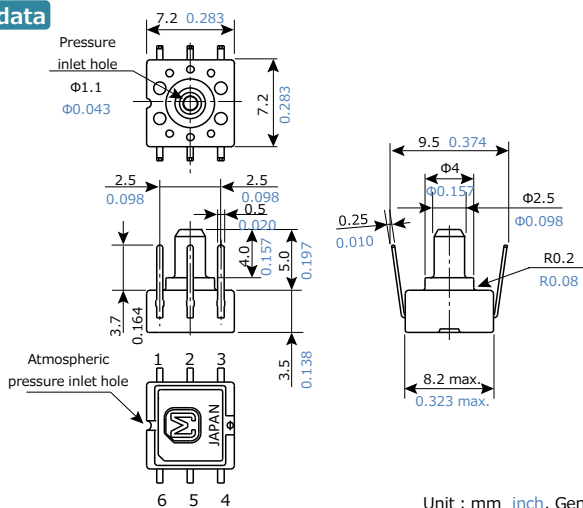

Recommended PC board pattern (BOTTOM VIEW)

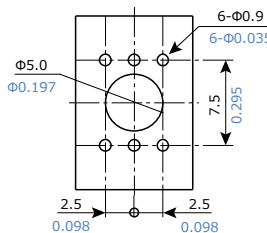

Terminal connection diagram

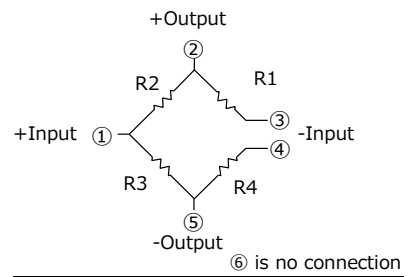

Terminal No.	Name
1	Power supply (+)
2	Output (+)
3	Power supply (-)
4	Power supply (-)
5	Output (-)
6	NC (No connection)

Note: Leave terminal 6 unconnected.

Unit : mm inch, General tolerance $\pm 0.3 \pm 0.012$

- Terminal direction : SMD terminal ADP4932, ADP4933

CAD data

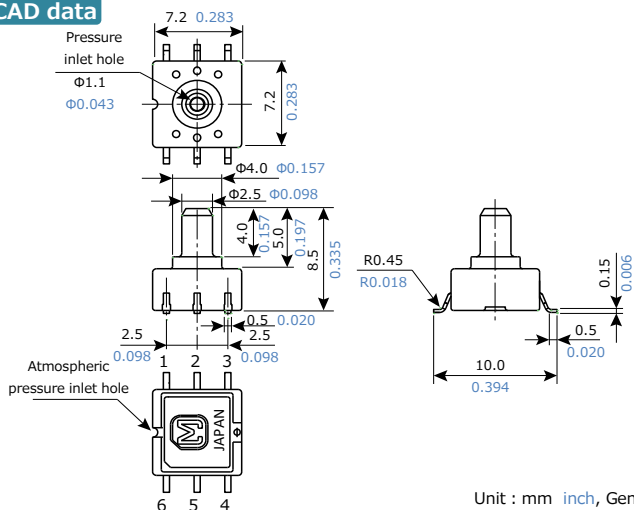

Recommended PC board pattern (BOTTOM VIEW)

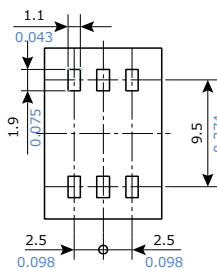

Terminal connection diagram

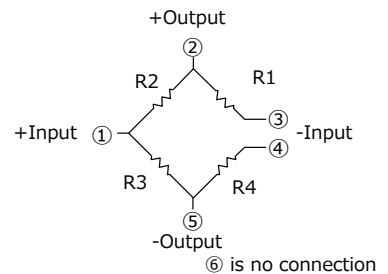

Terminal No.	Name
1	Power supply (+)
2	Output (+)
3	Power supply (-)
4	Power supply (-)
5	Output (-)
6	NC (No connection)

Note: Leave terminal 6 unconnected.

Unit : mm inch, General tolerance $\pm 0.3 \pm 0.012$

Dimensions

The CAD data of the products with a **CAD data** mark can be downloaded from: <http://industrial.panasonic.com/>

[PF pressure sensor]

- Terminal direction : DIP terminal Direction opposite to the pressure inlet direction ADP11□□(□)

CAD data

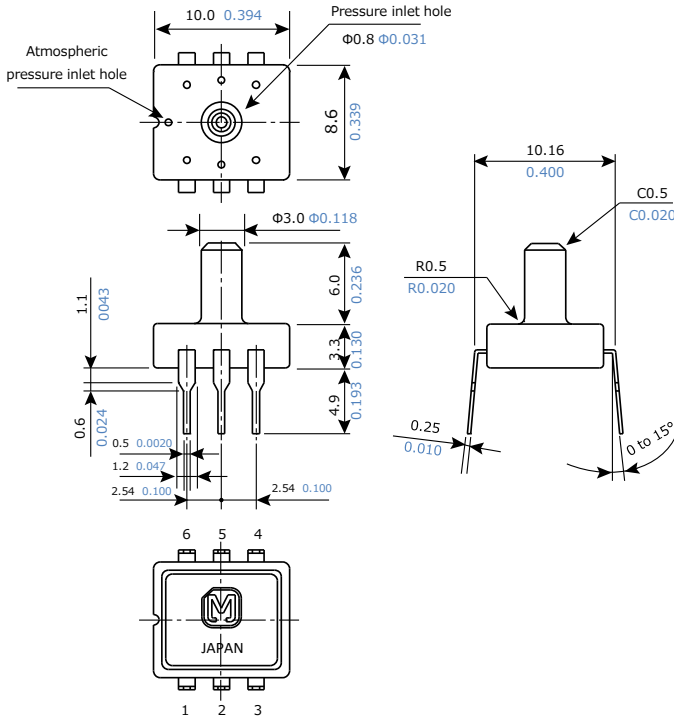

Recommended PC board pattern (BOTTOM VIEW)

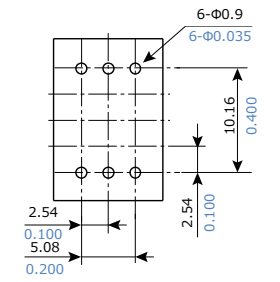

Terminal connection diagram

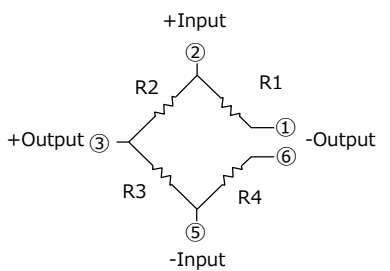

Terminal No.	Name
1	-Output (-)
2	Power supply (+)
3	+Output (+)
4	No connection
5	Power supply (-)
6	-Output (-)

Note: Leave terminal 4 unconnected.

unit : mm inch, General tolerance : ±0.3 ±0.012

- Terminal direction : DIP terminal Pressure inlet direction ADP12□□(□)

CAD data

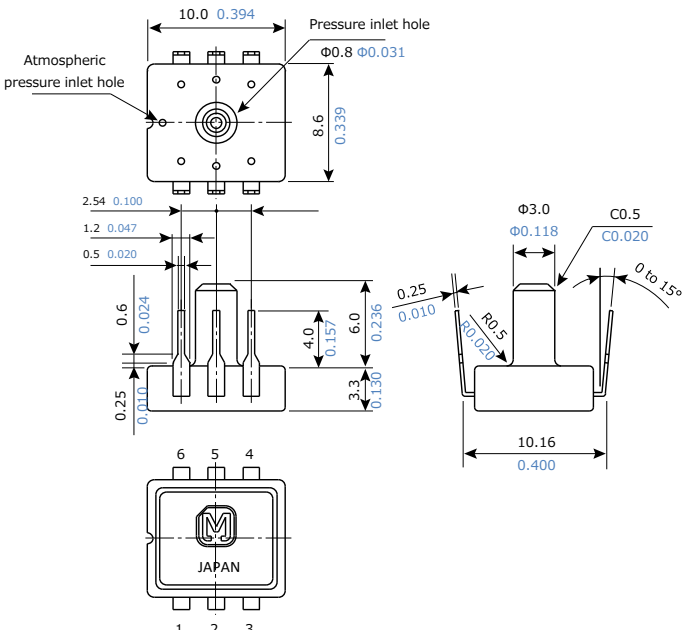

Recommended PC board pattern (BOTTOM VIEW)

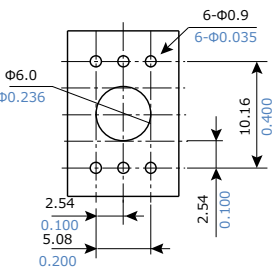

Terminal connection diagram

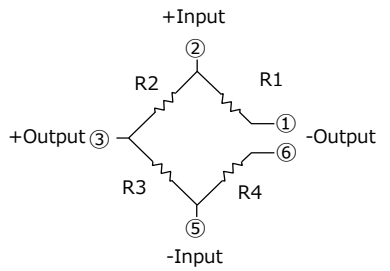

Terminal No.	Name
1	-Output (-)
2	Power supply (+)
3	+Output (+)
4	No connection
5	Power supply (-)
6	-Output (-)

Note: Leave terminal 4 unconnected.

unit : mm inch, General tolerance : ±0.3 ±0.012

Guidelines and precautions regarding the technical information and use of our products described in this online catalog.

- If you want to use our products described in this online catalog for applications requiring special qualities or reliability, or for applications where the failure or malfunction of the products may directly jeopardize human life or potentially cause personal injury (e.g. aircraft and aerospace equipment, traffic and transportation equipment, combustion equipment, medical equipment, accident prevention, anti-crime equipment, and/or safety equipment), it is necessary to verify whether the specifications of our products fit to such applications. Please ensure that you will ask and check with our inquiry desk as to whether the specifications of our products fit to such applications use before you use our products.
- The quality and performance of our products as described in this online catalog only apply to our products when used in isolation. Therefore, please ensure you evaluate and verify our products under the specific circumstances in which our products are assembled in your own products and in which our products will actually be used.
- If you use our products in equipment that requires a high degree of reliability, regardless of the application, it is recommended that you set up protection circuits and redundancy circuits in order to ensure safety of your equipment.
- The products and product specifications described in this online catalog are subject to change for improvement without prior notice. Therefore, please be sure to request and confirm the latest product specifications which explain the specifications of our products in detail, before you finalize the design of your applications, purchase, or use our products.
- The technical information in this online catalog provides examples of our products' typical operations and application circuits. We do not guarantee the non-infringement of third party's intellectual property rights and we do not grant any license, right, or interest in our intellectual property.
- If any of our products, product specifications and/or technical information in this online catalog is to be exported or provided to non-residents, the laws and regulations of the exporting country, especially with regard to security and export control, shall be observed.

<Regarding the Certificate of Compliance with the EU RoHS Directive/REACH Regulations>

- The switchover date for compliance with the RoHS Directive/REACH Regulations varies depending on the part number or series of our products.
- When you use the inventory of our products for which it is unclear whether those products are compliant with the RoHS Directive/REACH Regulation, please select "Sales Inquiry" in the website inquiry form and contact us.

We do not take any responsibility for the use of our products outside the scope of the specifications, descriptions, guidelines and precautions described in this online catalog.

Safety precautions

- Do not use these sensors under any circumstances in which the range of their ratings, environment conditions or other specifications are exceeded. Using the sensors in any way which causes their specifications to be exceeded may generate abnormally high levels of heat, emit smoke, etc., resulting in damage to the circuitry and possibly causing an accident.
- Before connecting a connector, check the pin layout by referring to the connector wiring diagram, specifications diagram, etc., and make sure that the connector is connected properly. Take note that mistakes made in connection may cause unforeseen problems in operation, generate abnormally high levels of heat, emit smoke, etc., resulting in damage to the circuitry.
- Do not use any motion sensor which has been disassembled or remodeled.
- Protection circuit recommended.
The possible failure mode is either open or short of the output transistor.
An excess heat is the cause for short mode failure. For any important and serious application in terms of safety, add protection circuit or any other protection method.
 - Various safety equipment and safety equipment
 - Traffic light
 - Security crime prevention equipment
 - Equipment concerning control and safety of trains, cars, etc.
 - Applications such as temperature control using sensor output etc.
- If it is expected that malfunction of each sensor may cause injury to persons or serious expansion damage, be sure to implement safety measures such as double safety circuit.

Request for ordering and use

The products and specifications listed in this document are subject to change for product improvement, etc. (including specification changes and discontinued manufacturing). When examining mass-production design or placing an order for the listed products, please contact Panasonic to make sure that the information listed in this document is up-to-date.

- If it is expected that malfunction of each sensor may cause injury to persons or serious expansion damage, be sure to implement safety measures.
 - Reference Standards : Computers, office automation equipment, communications equipment, audio-video products, home electrical appliances, machine tools, personal devices, industrial robots.
 - Special Standards : Transportation equipment (automobiles, trains, ships, etc.), traffic signal equipment, crime and disaster prevention devices, electric power equipment, various safety devices, and medical equipment not directly targeted for life support
 - Specified Standards : Aircraft equipment, aeronautical and space equipment, seabed relay equipment, nuclear power control systems, and medical equipment, devices and systems for life support.
- Before considering the use of our products under the following conditions, you must contact one of our customer service representatives without fail and exchange written specifications.
 - When our products are to be used in any of the applications listed for the Special Standards or Specified Standards.
 - When, even for any of the applications listed for the Reference Standards, our products may possibly be used beyond the range of the specifications, environment or conditions listed in the document or when you are considering the use of our products in any conditions or an environment that is not listed in the document.

[Acceptance Inspection]

For a purchased or delivered product, please conduct an acceptance inspection promptly with adequate consideration given to the management and maintenance of the product before and during the acceptance inspection.

[Warranty Period]

The warranty period of these products is one year after the purchase or delivery to a location designated by your company, unless otherwise specified by both parties.

[Scope of Warranty]

If a failure or a defect attributable to Panasonic is found during the warranty period, we will promptly provide a replacement or a necessary replacement part or change/repair the defective part free of charge at the location of the purchase or delivery.

The warranty does not cover a failure or a defect when any of the following applies :

- (1) Caused by specifications, standards, or handling methods, etc. designated by your company.
- (2) Caused by modification of the structure, capabilities, or specifications, etc., in which Panasonic is not engaged, carried out after the purchase or delivery.
- (3) Caused by an unforeseen phenomenon that cannot be predicted with the technologies available after the time of the purchase or at the time of concluding the agreement.
- (4) When the product was used outside the scope of the conditions/environments described in the catalog or specifications.
- (5) When the product is incorporated in your company's equipment for use, damages that could be avoided if your company's equipment had industry-standard functions, structures, etc.
- (6) Caused by natural disasters or Force Majeure.

The warranty described here is limited to the purchased or delivered product only and does not cover any consequential damages arising from the failure or defect of the product.

[Before Purchase]

- The standard prices of the products listed in this catalog do not include consumption tax, delivery, installation & adjustment fees, used product collection fees, etc.
- The specifications/appearance are subject to change without notice for product improvement.
- The export of products that fall into the category of strategic goods (or services) require an export (or a service transaction) license under the Foreign Exchange and Foreign Trade Law. Please contact Panasonic for details.
- For details of the products listed in this catalog, please contact distributors, specialty contractor stores, or Panasonic.

Notes

■ Mounting

Use the land of the printed-circuit board on which the sensor is securely fixed.

■ Soldering

Avoid the external thermal influence as the product has a limited thermal capacity due to its compact structure. Heat deformation may damage the sensor or deteriorate its performance. Use the non-corrosive rosin flux. Prevent the flux from entering into the inside of the product as the sensor is exposed to the atmosphere.

(1) Manual soldering

- Raise the temperature of the soldering tip between 260 and 300 °C 500 and 572 °F (30 W) and solder within 5 seconds.
- The sensor output may vary if the load is applied on the terminal during soldering.
- Keep the soldering tip clean.

(2) DIP soldering (DIP Terminal)

- Keep the temperature of the DIP solder tank below 260 °C 500 °F and solder within 5 seconds.
- To avoid heat deformation, do not perform DIP soldering when mounting on the circuit board which has a small thermal capacity.

(3) Reflow soldering (SMD Terminal)

- The recommended reflow temperature profile conditions are given below.

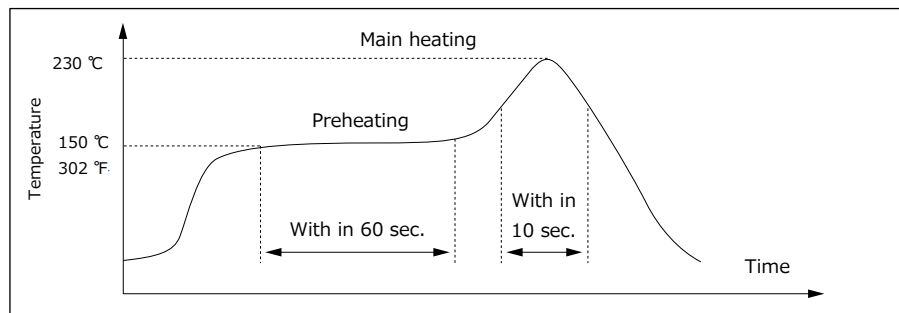

- We recommend the screen solder printing method as the method of cream.
 - Please refer to the recommended PC board specification diagram for the PC board foot pattern.
 - Self alignment may not always work as expected, therefore, please carefully the position of the terminals and pattern.
 - The temperature of the profile is assumed to be a value measured with the printed wiring board of the terminal neighborhood.
 - Please evaluate solderability under the actual mounting conditions since welding and deformation of the pressure inlet port may occur due to heat stress depending on equipments or conditions.
- (4) Rework soldering
- Complete rework at a time.
 - Use a flattened soldering tip when performing rework on the solder bridge. Do not add the flux.
 - Keep the soldering tip below the temperature described in the specifications.
- (5) Avoid drop and rough handling as excessive force may deform the terminal and damage soldering and rough handling as excessive force may deform the terminal and damage soldering
- (6) Keep the circuit board warpage within 0.05 mm of the full width of the sensor.
- (7) After soldering, do not apply stress on the soldered part when cutting or bending the circuit board.
- (8) Prevent human hands or metal pieces from contacting with the sensor terminal.
Such contact may cause anomalous outlets as the terminal is exposed to the atmosphere.
- (9) After soldering, prevent chemical agents from adhering to the sensor when applying coating to avoid insulation deterioration of the circuit board.
- (10) Please consult us concerning leadfree soldering.

■ Cleaning

- (1) Prevent cleaning liquid from entering the inside of the product as the sensor is exposed to the atmosphere.
- (2) Do not perform ultrasonic cleaning in order to prevent damages to the product.

Notes

■ Environment

- (1) Avoid use and storage in the corrosive gas (organic solvent, sulfurous acid and hydrogen sulfide gases) which negatively affects the product.
- (2) Avoid use in a place where these products come in contact with water as the sensor does not have a splashproof construction.
- (3) Avoid use in an environment where these products cause dew condensation.
When water attached to the sensor chip freezes, the sensor output may be fluctuated or damaged.
- (4) Due to the structure of the pressure sensor chip, the output varies under light.
Do not expose the sensor chip to light when applying a voltage by using a transparent tube.
- (5) Do not apply high-frequency oscillation, such as ultrasonic waves, to the product.

■ Quality check under actual use conditions

These specifications are for individual components. Before use, carefully check the performance and quality under actual use conditions to enhance stability.

■ Other precautions

- (1) The wrong mounting method and the pressure range may invite the risk of accidents.
- (2) Only applicable pressure medium is dry air. Avoid use in the corrosive gas (organic solvent, sulfurous acid and hydrogen sulfide gases) or other mediums containing moisture or foreign substances. Such mediums may damage or break the product.
- (3) The pressure sensor chip is located inside the pressure introduction port. Do not insert foreign substances, such as wires, into the port as those substances may damage the chip and close the port. Do not block the atmosphere introduction port.
- (4) Use electric power within the rated power range. Use beyond the range may damage the product.
- (5) Follow below instructions as static electricity may damage the product.
 - For Storage, short the circuit between terminals by using conductive substances or wrap the whole chip with aluminum foil. For storage and transportation, avoid plastic containers which are easily electrified.
 - Before use, connect electrified materials on desk and operators to the ground in order to safely discharge static electricity.
- (6) Carefully select and fix tubes, introduction pipes and products based on the working voltage. Please contact us for any inquires.

Application circuit diagram (Example)

The pressure sensor converts a voltage by constant current drive and if necessary, amplifies the voltage.

The circuit on the right is a typical use example.

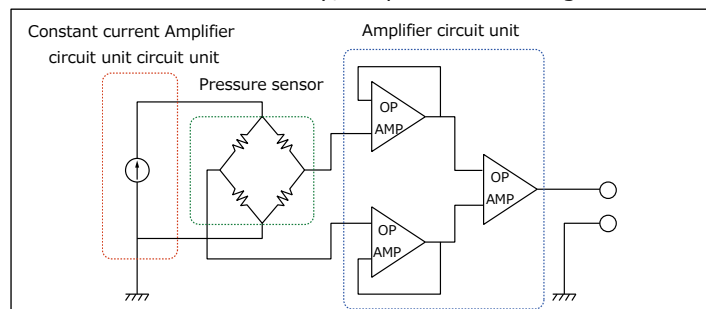

Mounting method

The general method of air pressure transmission varies depending on the low/high pressure condition.

● Usage note

- ① Select a sturdy pressure introduction pipe to avoid pressure leak.
- ② Securely fix the pressure introduction pipe to avoid pressure leak.
- ③ Do not block the pressure introduction pipe.

Methods of transmitting air pressures

