

LC-R122R2P*1

FOR MAIN AND STANDBY POWER SUPPLIES.
 EXPECTED TRICKLE DESIGN LIFE: 6 – 9 YEARS AT 20°C
 ACCORDING TO EUROBAT.

VdS
 G188151

DIMENSIONS (MM)

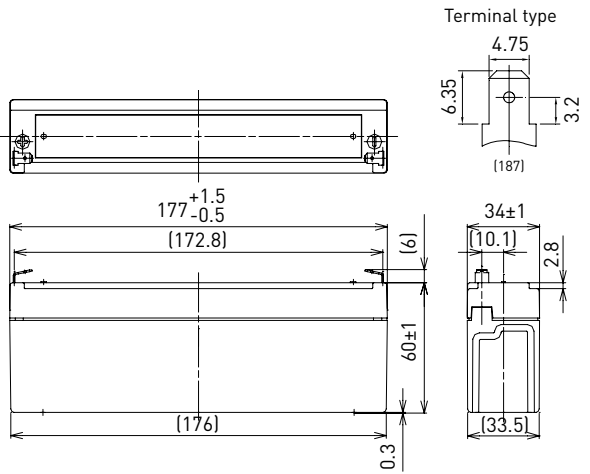

Contents indicated (including the recycle marking, etc.) are subject to change without notice.

Battery case resin: standard (UL94 HB)

SPECIFICATIONS		
Name	LC-R122R2PG*1	
Nominal voltage	12V	
Nominal capacity (20 hour rate)	2.2Ah	
Dimensions	Length	177mm
	Width	34mm
	Height	66mm
Approx. mass	0.80kg	
Terminal	Faston 187	
Capacity (25°C)	20 hour rate	2.2Ah
	10 hour rate	2.0Ah
	3 hour rate	1.8Ah
	1 hour rate	1.5Ah
Impedance	Fully charged battery (25°C)	70mΩ
	40°C	102%
Temperature dependency of capacity (20 hour rate)	25°C	100%
	0°C	85%
	-15°C	65%
Self-discharge (25°C)	After 3 month	91%
	After 6 month	82%
	After 12 month	64%

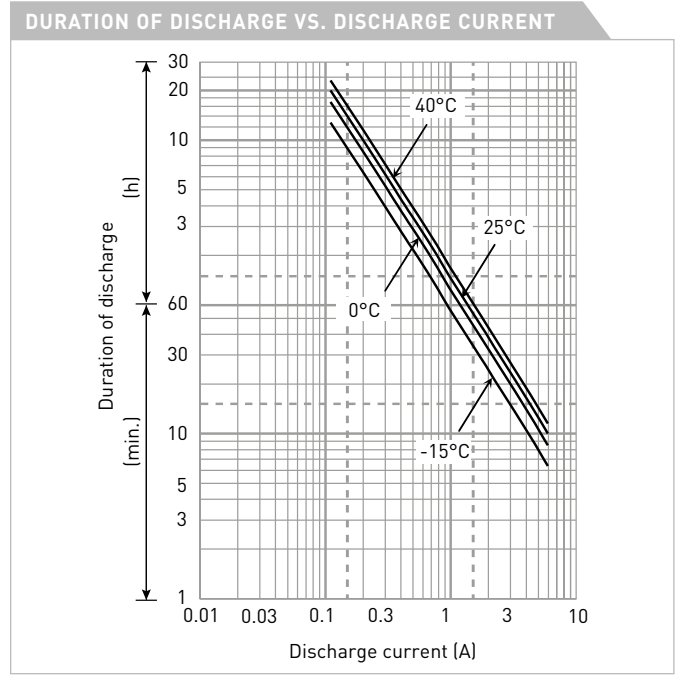

WATT TABLE (25°C)																[Wattage/battery]
Cut-off	3min.	5min.	10min.	15min.	20min.	30min.	45min.	1h	1.5h	2h	3h	4h	5h	6h	10h	20h
9.6V	132	104	68.1	52.0	43.6	32.5	23.0	18.4	12.6	9.77	7.27	5.59	4.61	3.71	2.46	1.33
9.9V	123	97.8	66.7	51.7	42.9	32.2	22.8	18.2	12.4	9.70	7.24	5.55	4.58	3.69	2.45	1.33
10.2V	113	91.6	65.0	50.6	42.2	31.8	22.6	18.0	12.1	9.44	7.16	5.51	4.54	3.66	2.42	1.32
10.5V	101	82.1	60.2	47.1	40.1	31.1	22.2	17.6	11.9	9.12	7.05	5.48	4.50	3.62	2.41	1.32
10.8V	84.9	72.6	53.7	43.9	39.0	30.0	21.9	17.3	11.5	8.68	6.91	5.40	4.39	3.56	2.38	1.31

AMPERE TABLE (25°C)																[Ampere/battery]
Cut-off	3min.	5min.	10min.	15min.	20min.	30min.	45min.	1h	1.5h	2h	3h	4h	5h	6h	10h	20h
9.6V	11.9	9.35	6.08	4.52	3.76	2.78	1.96	1.56	1.07	0.825	0.611	0.468	0.385	0.309	0.205	0.111
9.9V	11.0	8.77	5.96	4.49	3.70	2.75	1.94	1.55	1.05	0.819	0.608	0.464	0.382	0.308	0.204	0.111
10.2V	10.2	8.22	5.81	4.40	3.64	2.72	1.93	1.53	1.03	0.798	0.602	0.461	0.379	0.306	0.202	0.110
10.5V	9.04	7.36	5.38	4.09	3.45	2.66	1.89	1.50	1.01	0.770	0.593	0.458	0.376	0.302	0.201	0.110
10.8V	7.64	6.51	4.80	3.82	3.36	2.57	1.86	1.47	0.978	0.733	0.581	0.452	0.367	0.297	0.199	0.109

All mentioned values are average values

LC-R122R2P*1

CHARGING METHOD (25°C)

Cycle use Control voltage: 14.5V - 14.9V
Initial current: 0.88A or smaller

CUT-OFF VOLTAGE

Discharge current	0.110A - 0.440A	0.440A - 1.10A	1.10A - 2.20A	2.00A - 4.40A	4.40A - 6.60A
Cut-off voltage	10.5V	10.2V	9.9V	9.3V	8.7V

CYCLE LIFE VS. DEPTH OF DISCHARGE (ACC. IEC 61056)

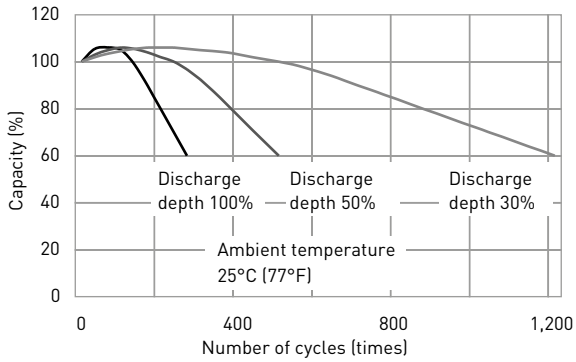

RESIDUAL CAPACITY TEST RESULT

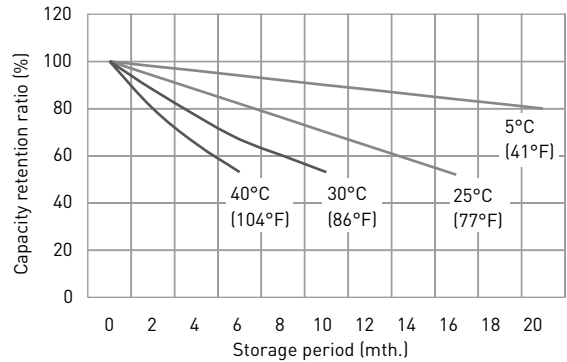

CONSTANT-VOLTAGE CONSTANT-CURRENT CHARGE CHARACTERISTICS FOR CYCLE USE

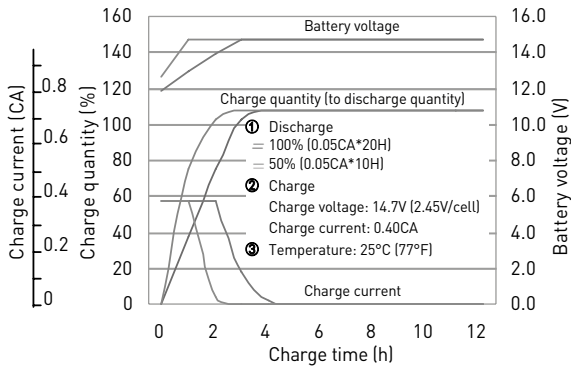

DISCHARGE CAPACITY BY TEMPERATURE AND BY DISCHARGE CURRENT

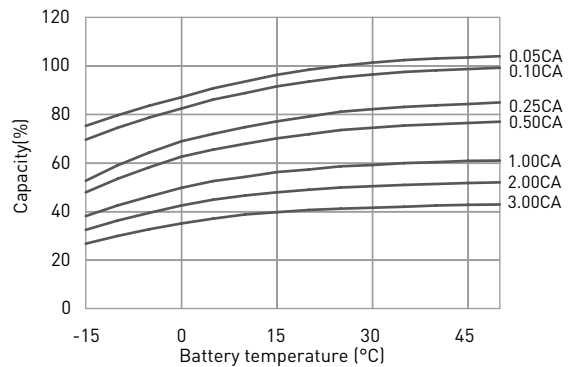

DISCHARGE CHARACTERISTICS

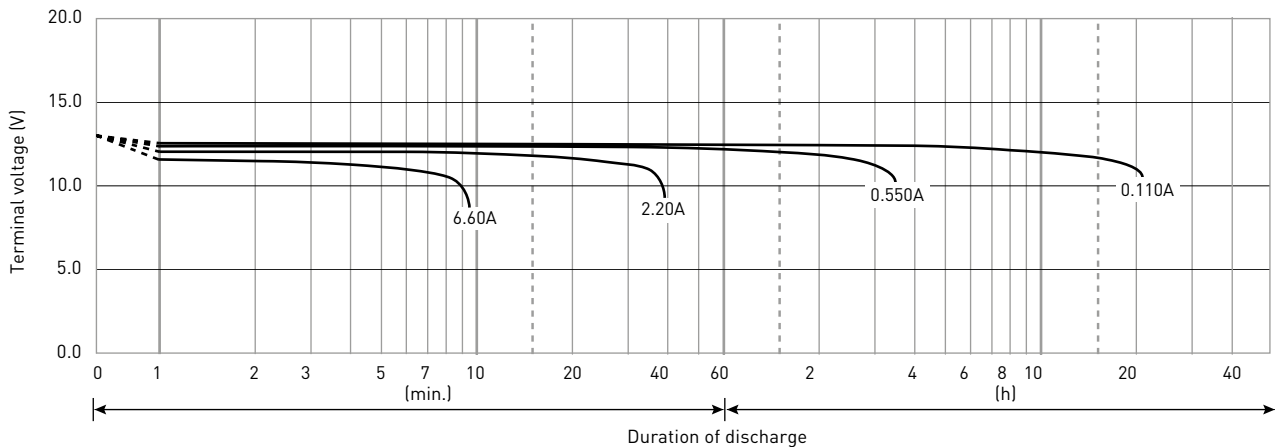

The data in this document are for descriptive purposes only and are not intended to make or imply any guarantee or warranty. Regarding handling and safety please consult our VRLA technical handbook chapter 1.

*1 This battery is also available with a flame retardant battery case resin (UL94 V-0): LC-V122R2PG.