

LC-XC1238P/AP

FOR MAIN POWER SUPPLIES.
CYCLE LONG-LIFE TYPE

DIMENSIONS (MM)

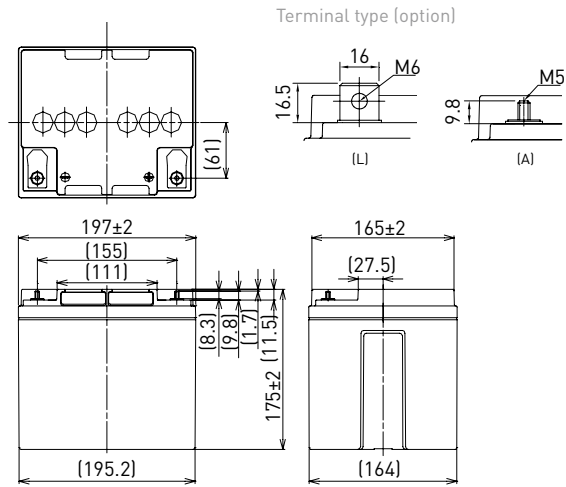

Contents indicated (including the recycle marking, etc.) are subject to change without notice. Battery case resin: standard (UL94 HB)

Specifications		LC-XC1238P/AP
Nominal voltage (V)		12
Nominal capacity	20 hours rate (Ah)	38.0
Dimensions	Length (mm)	165
	Width (mm)	197
	Total height (mm)	179.5
Approx. mass (kg)		15.0
Terminal type	M6 bolt/nut & M5 threaded post	
Capacity (25°C)	20 hours rate (Ah)	38.0
	10 hours rate (Ah)	36.0
	3 hours rate (Ah)	29.0
	1 hour rate (Ah)	23.0
Impedance (mΩ)	Fully charged battery (25°C)	8
	40°C	102
Temperature dependency of capacity (%) - 20 hours rate	25°C	100
	0°C	85
	-15°C	65
	Remaining capacity (25°C)	After 3 months (%)
After 6 months (%)		82
After 12 months (%)		64

DURATION OF DISCHARGE VS. DISCHARGE CURRENT

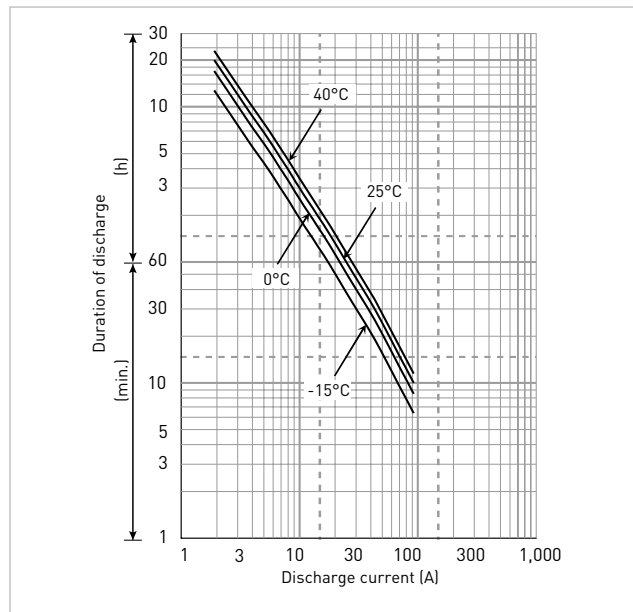

WATT TABLE (25°C)

(Wattage/battery)

Cut-off	5min.	10min.	15min.	20min.	30min.	45min.	1h	1.5h	2h	3h	4h	5h	6h	10h	20h
9.6V	1,349	1,030	800	686	505	351	276	214	169	123	99.2	77.9	68.3	42.0	22.8
9.9V	1,271	1,008	788	682	500	350	269	209	168	120	98.0	76.7	68.0	42.0	22.8
10.2V	1,204	980	768	672	489	349	267	185	167	119	96.8	75.5	67.7	42.0	22.8
10.5V	1,126	952	748	661	480	346	265	183	166	117	95.6	74.9	67.4	42.0	22.8
10.8V	1,098	874	716	640	468	308	247	175	155	114	94.4	74.3	67.1	42.0	22.8

AMPERE TABLE (25°C)

(Ampere/battery)

Cut-off	5min.	10min.	15min.	20min.	30min.	45min.	1h	1.5h	2h	3h	4h	5h	6h	10h	20h
9.6V	121	92.0	69.6	59.1	43.2	29.9	23.4	18.1	14.3	10.3	8.30	6.50	5.70	3.60	1.90
9.9V	114	90.0	68.5	58.8	42.7	29.8	22.8	17.7	14.2	10.1	8.20	6.40	5.68	3.60	1.90
10.2V	108	87.5	66.8	57.9	41.8	29.7	22.7	15.7	14.1	10.0	8.10	6.30	5.66	3.60	1.90
10.5V	101	85.0	65.0	57.0	41.0	29.5	22.5	15.5	14.0	9.80	8.00	6.25	5.64	3.60	1.90
10.8V	98.5	78.0	62.3	55.2	40.0	26.2	21.0	14.8	13.1	9.60	7.90	6.20	5.60	3.60	1.90

All mentioned values are average values

LC-XC1238P/AP

CHARGING METHOD (25°C)

Cycle use	Control voltage: 14.5V - 14.9V Initial current: 15.2A or smaller
------------------	---

CUT-OFF VOLTAGE

Discharge current	1.90A - 7.60A	7.60A - 19.0A	19.0A - 38.0A	38.0A - 76.0A	76.0A - 114A
Cut-off voltage	10.5V	10.2V	9.9V	9.3V	8.7V

CYCLE LIFE VS. DEPTH OF DISCHARGE (ACC. IEC 61056)

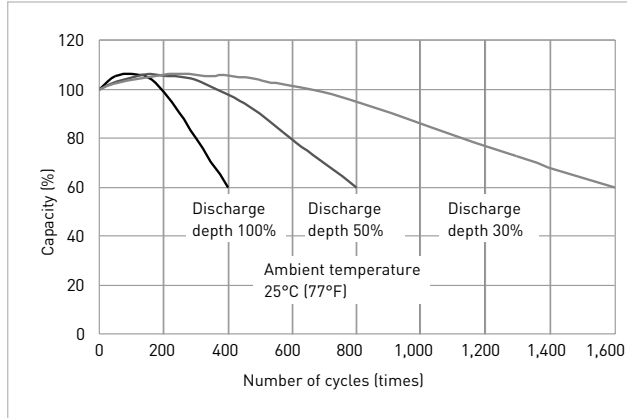

RESIDUAL CAPACITY TEST RESULT

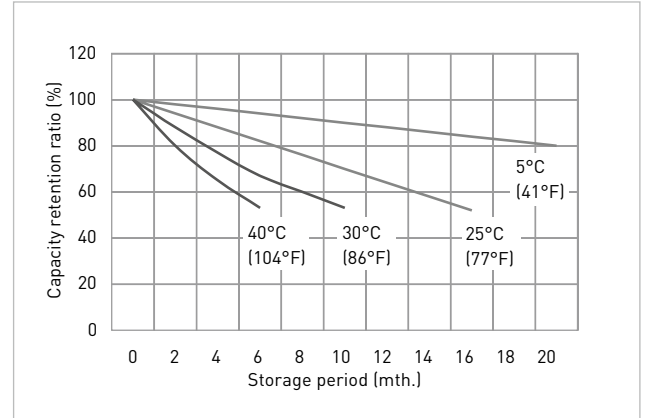

CONSTANT-VOLTAGE CONSTANT-CURRENT CHARGE CHARACTERISTICS FOR CYCLE USE

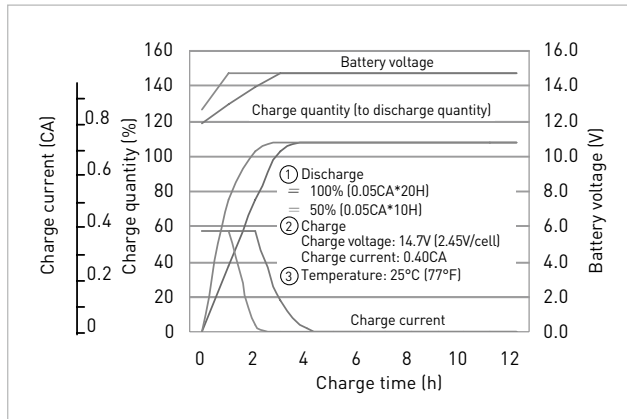

DISCHARGE CAPACITY BY TEMPERATURE AND BY DISCHARGE CURRENT

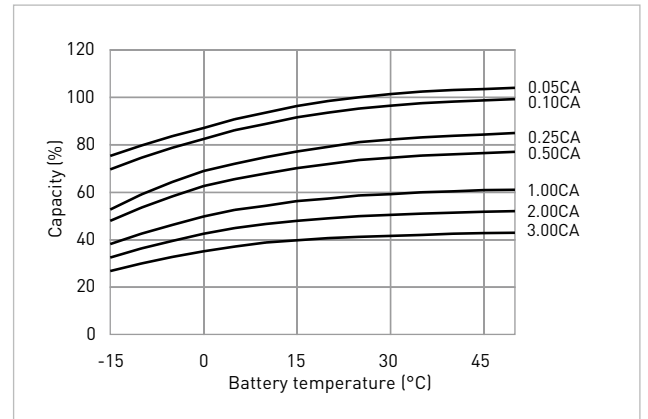

DISCHARGE CHARACTERISTICS

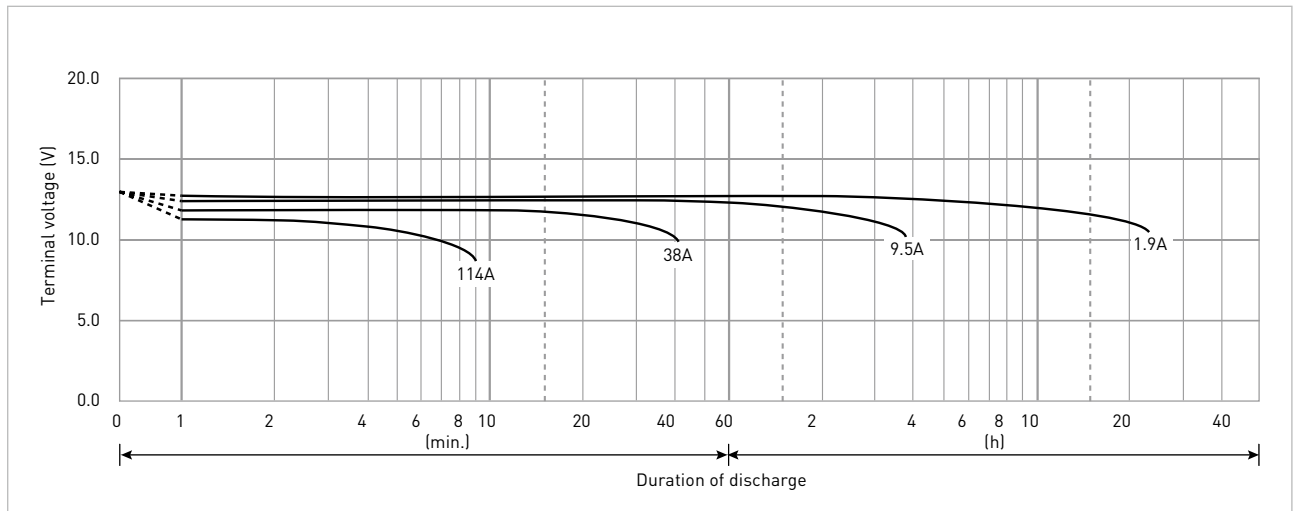

The data in this document are for descriptive purposes only and are not intended to make or imply any guarantee or warranty. Regarding handling and safety please consult our VRLA technical handbook chapter 'Precautions for handling VRLA batteries'.