

Inductors for power circuits

Wound ferrite

VLS-EX-H series (for automotive)



AEC-Q200

VLS6045EX-H type



FEATURES

- Magnetic shield type wound inductor for power circuits.
- High magnetic shield construction achieved by a ferrite magnetic material and compatible with high-density mounting.
- Larger current and lower Rdc were achieved by optimizing the ferrite core figure.
- Compliant with AEC-Q200

APPLICATION

- Automotive-related equipment (ECM, airbags, headlights, electronic power steering, meters, ABS, other)

PART NUMBER CONSTRUCTION

| | | | | | | | |
|-------------|------------------------------------|---------------|---|--------------------------|-------------------------|---|---------------|
| VLS | 6045 | EX | - | 1R0 | N | - | H |
| Series name | LxWxH dimensions 6.0x6.3x4.5 mm | Internal code | | Inductance (μ H) | Inductance tolerance | | Internal code |

CHARACTERISTICS SPECIFICATION TABLE

| L (μ H) | Measuring frequency | | DC resistance (Ω) \pm 30% | Rated current* | | Part No. |
|-----------------|---------------------|-------|---|-----------------|------------------|----------------------------------|
| | Tolerance | (kHz) | | Isat (A)max. | Itemp (A)typ. | |
| 1.0 | \pm 30% | 100 | 0.012 | 12.0 | 6.0 | VLS6045EX-1R0N-H |
| 1.5 | \pm 30% | 100 | 0.017 | 8.2 | 5.3 | VLS6045EX-1R5N-H |
| 2.2 | \pm 30% | 100 | 0.019 | 7.5 | 5.1 | VLS6045EX-2R2N-H |
| 3.3 | \pm 30% | 100 | 0.023 | 6.5 | 4.95 | VLS6045EX-3R3N-H |
| 4.7 | \pm 20% | 100 | 0.027 | 5.8 | 4.2 | VLS6045EX-4R7M-H |
| 6.8 | \pm 20% | 100 | 0.036 | 4.7 | 3.6 | VLS6045EX-6R8M-H |
| 10 | \pm 20% | 100 | 0.047 | 3.9 | 3.4 | VLS6045EX-100M-H |
| 15 | \pm 20% | 100 | 0.075 | 3.1 | 2.5 | VLS6045EX-150M-H |
| 22 | \pm 20% | 100 | 0.105 | 2.4 | 1.9 | VLS6045EX-220M-H |
| 33 | \pm 20% | 100 | 0.175 | 1.9 | 1.5 | VLS6045EX-330M-H |
| 47 | \pm 20% | 100 | 0.23 | 1.8 | 1.3 | VLS6045EX-470M-H |
| 68 | \pm 20% | 100 | 0.31 | 1.4 | 1.0 | VLS6045EX-680M-H |
| 100 | \pm 20% | 100 | 0.47 | 1.1 | 0.9 | VLS6045EX-101M-H |
| 150 | \pm 20% | 100 | 0.76 | 0.9 | 0.7 | VLS6045EX-151M-H |
| 220 | \pm 20% | 100 | 1.15 | 0.8 | 0.5 | VLS6045EX-221M-H |

* Rated current: smaller value of either Isat or Itemp.

Isat: When based on the inductance change rate (30% below the initial L value)

Itemp: When based on the temperature increase (temperature increase of 40°C by self heating)

Measurement equipment

| Measurement item | Product No. | Manufacturer |
|--------------------|---------------------|--|
| L | 4294A | Keysight Technologies, Inc. (formerly Hewlett-Packard) |
| DC resistance | 34420A | Keysight Technologies, Inc. (formerly Hewlett-Packard) |
| Rated current Isat | 4284A+42841A+42842A | Keysight Technologies, Inc. (formerly Hewlett-Packard) |

* Equivalent measurement equipment may be used.

TEMPERATURE RANGE, INDIVIDUAL WEIGHT

| Operating temperature range* | Storage temperature range** | Individual weight |
|------------------------------|-----------------------------|-------------------|
| -40 to 125 °C | -40 to 125 °C | 0.6 g |

* Operating temperature range includes self-temperature rise.

** The storage temperature range is for after the assembly.



Please be sure to request delivery specifications that provide further details on the features and specifications of the products for proper and safe use. (1/4)
Please note that the contents may change without any prior notice due to reasons such as upgrading.

20200805

inductor_automotive_power_vls6045ex-h_en

VLS6045EX-H type

L FREQUENCY CHARACTERISTICS

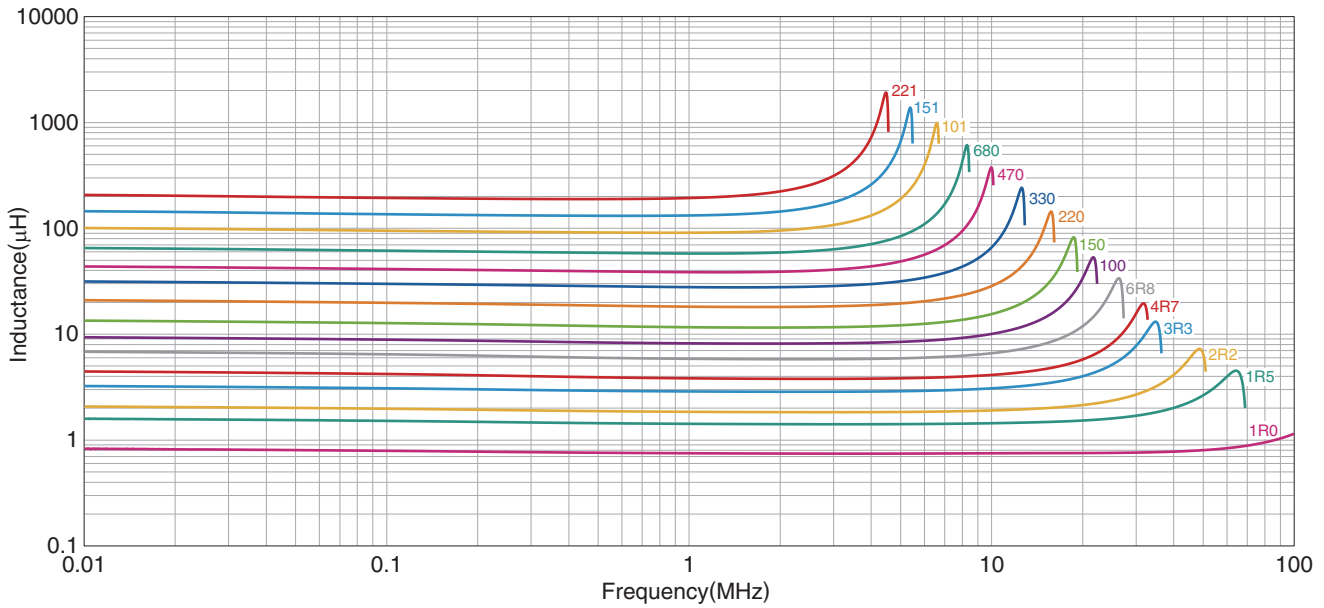

Measurement equipment

| Product No. | Manufacturer |
|-------------|--|
| 4294A | Keysight Technologies, Inc. (formerly Hewlett-Packard) |

* Equivalent measurement equipment may be used.

INDUCTANCE VS. DC BIAS CHARACTERISTICS

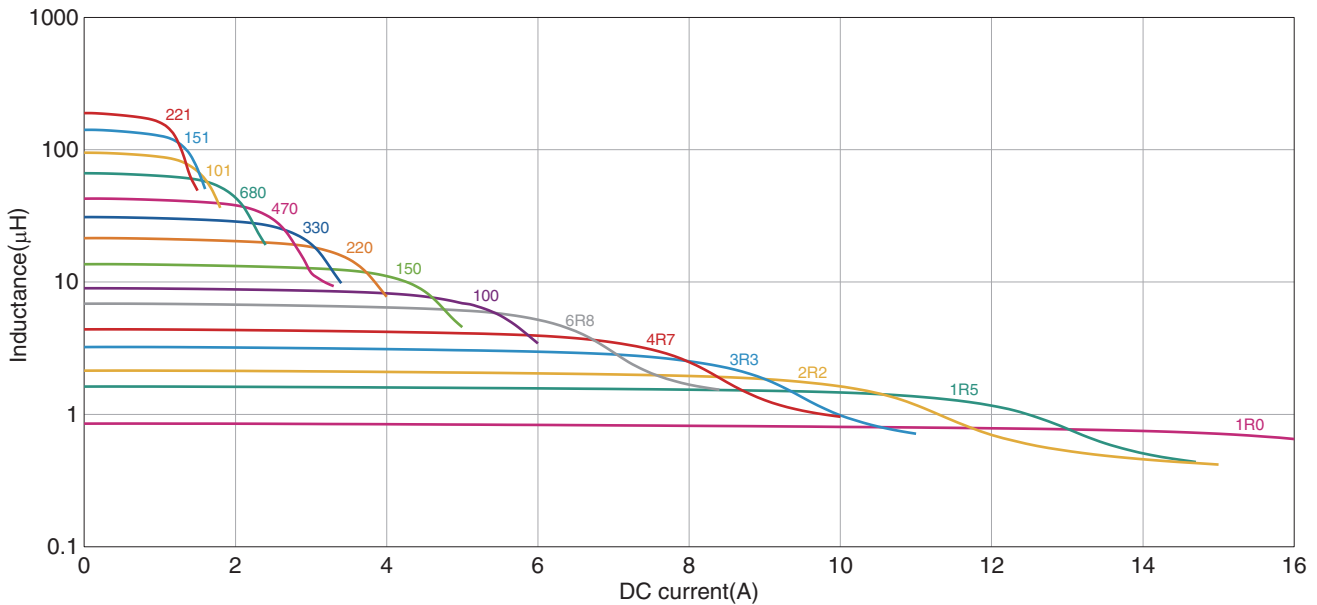

Measurement equipment

| Product No. | Manufacturer |
|---------------------|--|
| 4284A+42841A+42842A | Keysight Technologies, Inc. (formerly Hewlett-Packard) |

* Equivalent measurement equipment may be used.

VLS6045EX-H type

SHAPE & DIMENSIONS

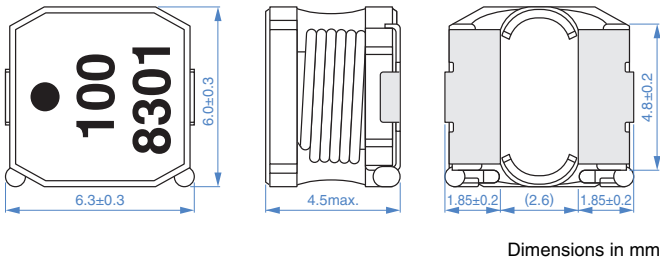

PACKAGING STYLE

REEL DIMENSIONS

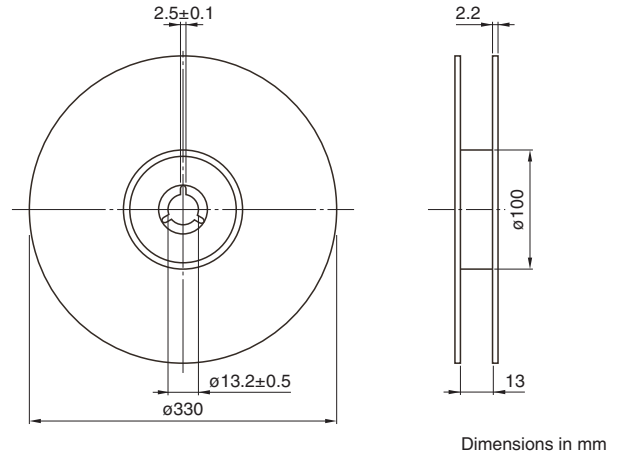

RECOMMENDED LAND PATTERN

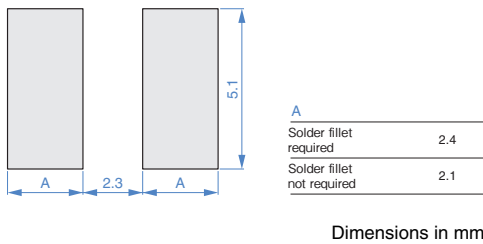

TAPE DIMENSIONS

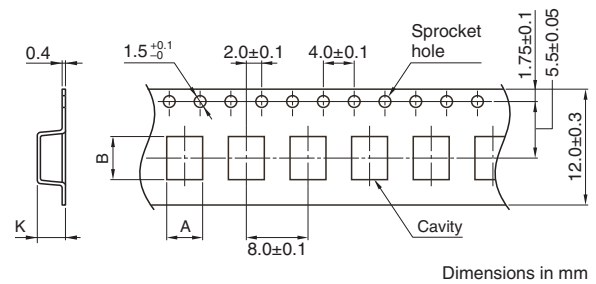

| Type | A | B | K |
|-------------|------|------|-----|
| VLS6045EX-H | 6.35 | 6.65 | 4.7 |

RECOMMENDED REFLOW PROFILE

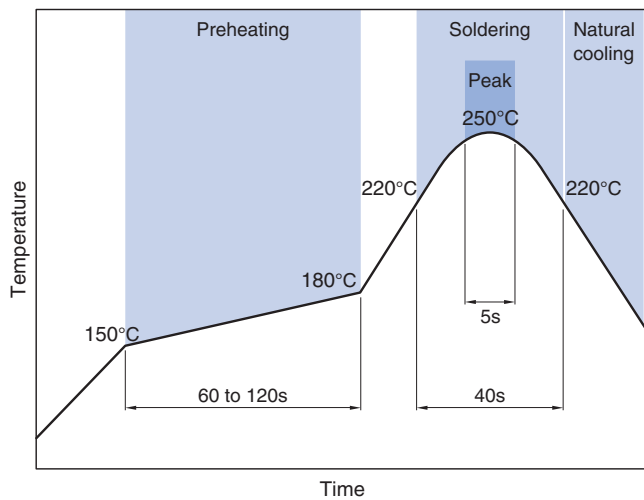

PACKAGE QUANTITY

| | |
|------------------|---------------|
| Package quantity | 1500 pcs/reel |
|------------------|---------------|

⚠ Please be sure to request delivery specifications that provide further details on the features and specifications of the products for proper and safe use. (3/4)
Please note that the contents may change without any prior notice due to reasons such as upgrading.

REMINDERS FOR USING THESE PRODUCTS

Before using these products, be sure to request the delivery specifications.

SAFETY REMINDERS

Please pay sufficient attention to the warnings for safe designing when using this products.

REMINDERS

- The storage period is within 12 months. Be sure to follow the storage conditions (temperature: 5 to 40°C, humidity: 0 to 75% RH or less).
If the storage period elapses, the soldering of the terminal electrodes may deteriorate.
- Do not use or store in locations where there are conditions such as gas corrosion (salt, acid, alkali, etc.).
- Before soldering, be sure to preheat components.
The preheating temperature should be set so that the temperature difference between the solder temperature and chip temperature does not exceed 150°C.
- Soldering corrections after mounting should be within the range of the conditions determined in the specifications.
If overheated, a short circuit, performance deterioration, or lifespan shortening may occur.
- When embedding a printed circuit board where a chip is mounted to a set, be sure that residual stress is not given to the chip due to the overall distortion of the printed circuit board and partial distortion such as at screw tightening portions.
- Self heating (temperature increase) occurs when the power is turned ON, so the tolerance should be sufficient for the set thermal design.
- Carefully lay out the coil for the circuit board design of the non-magnetic shield type.
A malfunction may occur due to magnetic interference.
- Use a wrist band to discharge static electricity in your body through the grounding wire.
- Do not expose the products to magnets or magnetic fields.
- Do not use for a purpose outside of the contents regulated in the delivery specifications.
- The products described in this catalog are intended to be installed in automobiles or automotive electronic equipment (AV equipment, telecommunications equipment, home appliances, amusement equipment, computer equipment, personal equipment, office equipment, measurement equipment, industrial robots) and to be used in automobiles (including the case where the said automotive product is mounted in a vehicle) or standard applications as general electronic equipment in automotive applications or standard applications as general electronic equipment in automotive applications in accordance with the scope and conditions described in this specification, while the said automotive or general electronic equipment including the said product is intended to be used in the usual operation and usage methods, respectively. Other than automotive or automotive products are not designed or warranted to meet the requirements of the applications listed below, whose performance and/or quality requires a more stringent level of safety or reliability, or whose failure, malfunction or defect could cause serious damage to society, person or property.

Please understand that we are not responsible for any damage or liability caused by use of the products in any of the applications below or for any other use exceeding the range or conditions set forth in this specification sheet.

If you intend to use the products in the applications listed below or if you have special requirements exceeding the range or conditions set forth in this specification, please contact us.

- | | |
|---|--|
| (1) Aerospace/aviation equipment | (8) Public information-processing equipment |
| (2) Transportation equipment (cars, electric trains, ships, etc.) | (9) Military equipment |
| (3) Medical equipment | (10) Electric heating apparatus, burning equipment |
| (4) Power-generation control equipment | (11) Disaster prevention/crime prevention equipment |
| (5) Atomic energy-related equipment | (12) Safety equipment |
| (6) Seabed equipment | (13) Other applications that are not considered general-purpose applications |
| (7) Transportation control equipment | |

When designing your equipment even for general-purpose applications, you are kindly requested to take into consideration securing protection circuit/device or providing backup circuits in your equipment.