



GaAs MMIC SUB-HARMONIC SMT MIXER, 14.5 - 19.5 GHz

Typical Applications

The HMC258LC3B is ideal for:

- Point to Point Radios
- VSAT and SATCOM
- Test & Measurement Equipment
- Military & Space

Features

- Integrated LO Amplifier: 0 dBm Input
- Sub-Harmonically Pumped (x2) LO
- High 2LO/RF Isolation: >45 dB
- Wide IF Bandwidth: DC - 3.5 GHz
- No External Matching Required
- RoHS Compliant 3x3mm Ceramic SMT Package

Functional Diagram

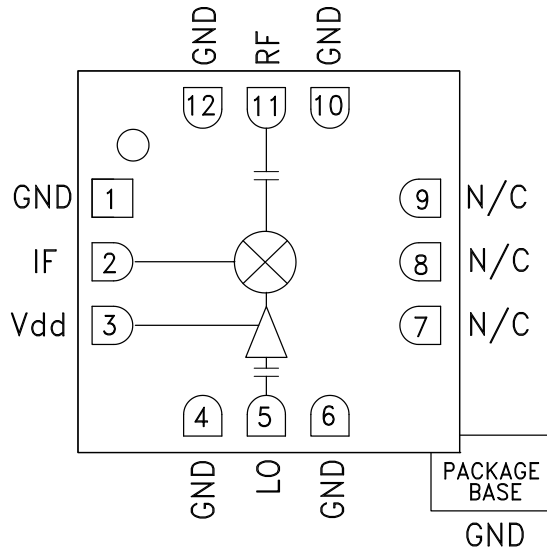

General Description

The HMC258LC3B is a 14.5 - 19.5 GHz surface mount sub-harmonically pumped (x2) MMIC mixer with an integrated LO amplifier in a SMT leadless ceramic package. At 45 dB the 2LO to RF isolation eliminates the need for additional filtering. The LO amplifier is a single bias (+5V) two stage design with only 0 dBm drive requirement. The HMC258LC3B requires no external matching components, making it ideal for integrated subsystem applications. Utilizing the HMC258LC3B eliminates the need for wire-bonding, thereby providing a consistent connection interface for the customer.

Electrical Specifications, $T_A = +25\text{ }^\circ\text{C}$, LO Drive = 0 dBm

Parameter	IF = 1 GHz Vdd = +5.0V			Units
	Min.	Typ.	Max.	
Frequency Range, RF	14.5 - 19.5			GHz
Frequency Range, LO	7.25 - 10			GHz
Frequency Range, IF	DC - 3.5			GHz
Conversion Loss		10	14	dB
Noise Figure (SSB)		10	14	dB
2LO to RF Isolation	35	45		dB
2LO to IF Isolation	30	40		dB
IP3 (Input)		5		dBm
1 dB Compression (Input)		-3		dBm
Supply Current (I _{dd})		42	57	mA

*Unless otherwise noted, all measurements performed as downconverter, IF = 1 GHz.

Information furnished by Analog Devices is believed to be accurate and reliable. However, no responsibility is assumed by Analog Devices for its use, nor for any infringements of patents or other rights of third parties that may result from its use. Specifications subject to change without notice. No license is granted by implication or otherwise under any patent or patent rights of Analog Devices. Trademarks and registered trademarks are the property of their respective owners.

For price, delivery, and to place orders: Analog Devices, Inc., One Technology Way, P.O. Box 9106, Norwood, MA 02062-9106 Phone: 781-329-4700 • Order online at www.analog.com Application Support: Phone: 1-800-ANALOG-D



GaAs MMIC SUB-HARMONIC SMT MIXER, 14.5 - 19.5 GHz

Conversion Gain vs. Temperature @ LO = 0 dBm

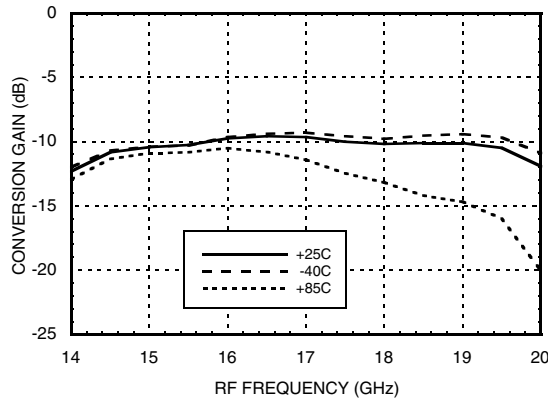

Conversion Gain vs. LO Drive

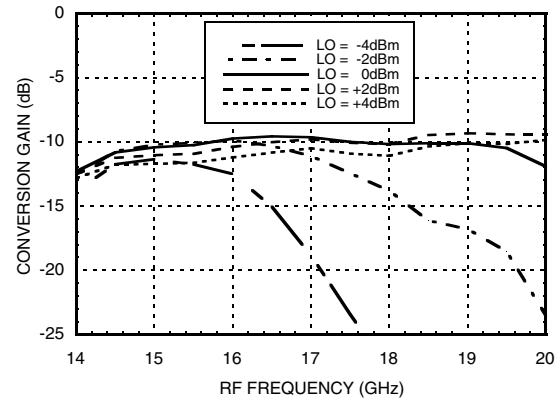

Isolation @ LO = 0 dBm

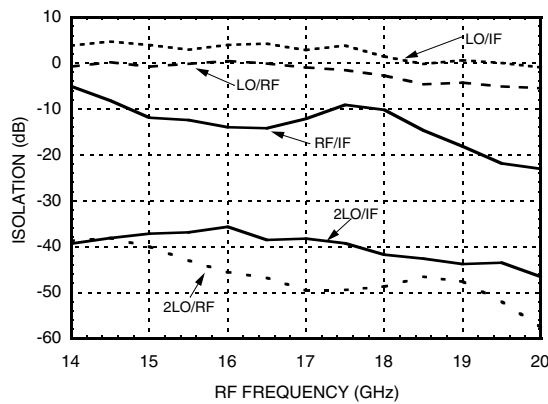

RF & LO Return Loss @ LO = 0 dBm

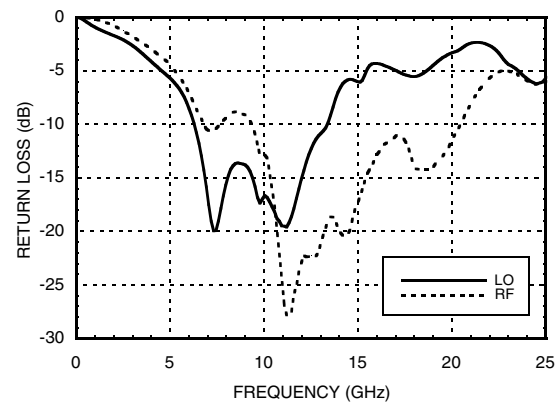

IF Bandwidth @ LO = 0 dBm

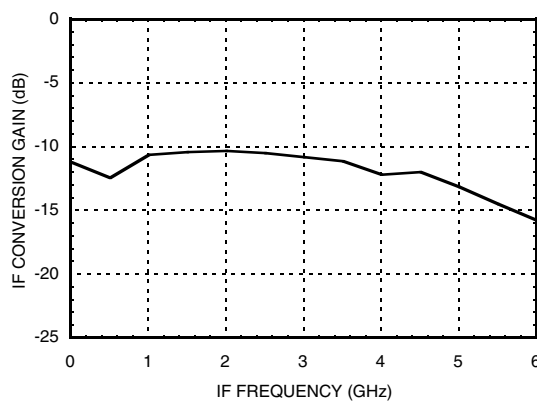

IF Return Loss @ LO = 0 dBm

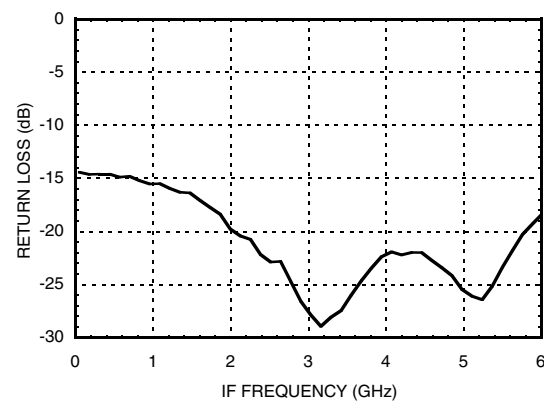

Information furnished by Analog Devices is believed to be accurate and reliable. However, no responsibility is assumed by Analog Devices for its use, nor for any infringements of patents or other rights of third parties that may result from its use. Specifications subject to change without notice. No license is granted by implication or otherwise under any patent or patent rights of Analog Devices. Trademarks and registered trademarks are the property of their respective owners.

For price, delivery, and to place orders: Analog Devices, Inc., One Technology Way, P.O. Box 9106, Norwood, MA 02062-9106 Phone: 781-329-4700 • Order online at www.analog.com Application Support: Phone: 1-800-ANALOG-D



GaAs MMIC SUB-HARMONIC SMT MIXER, 14.5 - 19.5 GHz

Input IP3 vs. LO Drive *

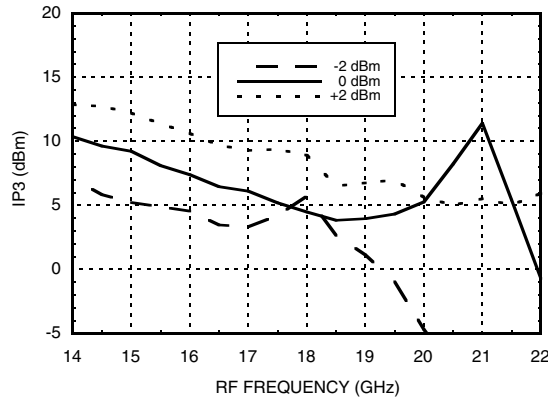

Input IP2 vs. LO Drive *

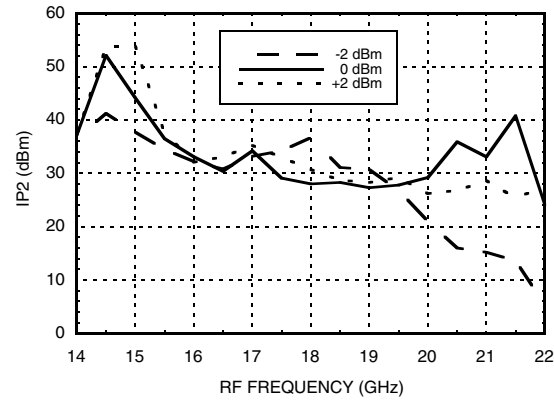

Input P1dB

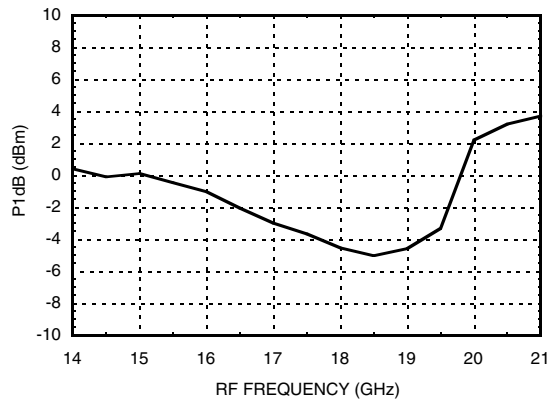

Upconverter Performance Conversion Gain @ LO = 0 dBm

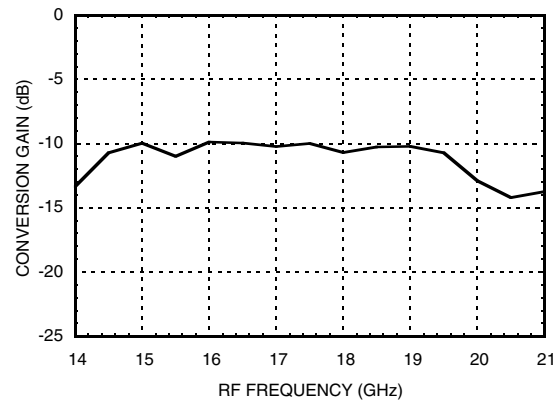

MxN Spurious Outputs @ LO = 0 dBm

mRF	nLO							
	-2	-4	-6	-8	9	7	5	3
1	X							
2		47.1						
3			34.5					
4				66.7				
-4					50.1			
-3						59.5		
-2							32.8	
-1								45.4

RF = 18 GHz @ -10 dBm
 LO = 8.5 GHz @ 0 dBm
 All values in dBc below IF power level.

* Two-tone input power = -10 dBm each tone, 1 MHz spacing.

Information furnished by Analog Devices is believed to be accurate and reliable. However, no responsibility is assumed by Analog Devices for its use, nor for any infringements of patents or other rights of third parties that may result from its use. Specifications subject to change without notice. No license is granted by implication or otherwise under any patent or patent rights of Analog Devices. Trademarks and registered trademarks are the property of their respective owners.

For price, delivery, and to place orders: Analog Devices, Inc., One Technology Way, P.O. Box 9106, Norwood, MA 02062-9106 Phone: 781-329-4700 • Order online at www.analog.com Application Support: Phone: 1-800-ANALOG-D



GaAs MMIC SUB-HARMONIC SMT MIXER, 14.5 - 19.5 GHz

Absolute Maximum Ratings

RF / IF Input (Vdd = +5V)	+13 dBm
LO Drive (Vdd = +5V)	+13 dBm
Vdd	+5.5V
Continuous P _{diss} (T _a = 85 °C) (derate 2.1 mW/°C above 85 °C)	486 mW
Channel Temperature	150 °C
Thermal Resistance (channel to ground paddle)	133.6 °C/W
Storage Temperature	-65 to +150 °C
Operating Temperature	-40 to +85 °C



ELECTROSTATIC SENSITIVE DEVICE
OBSERVE HANDLING PRECAUTIONS

Outline Drawing

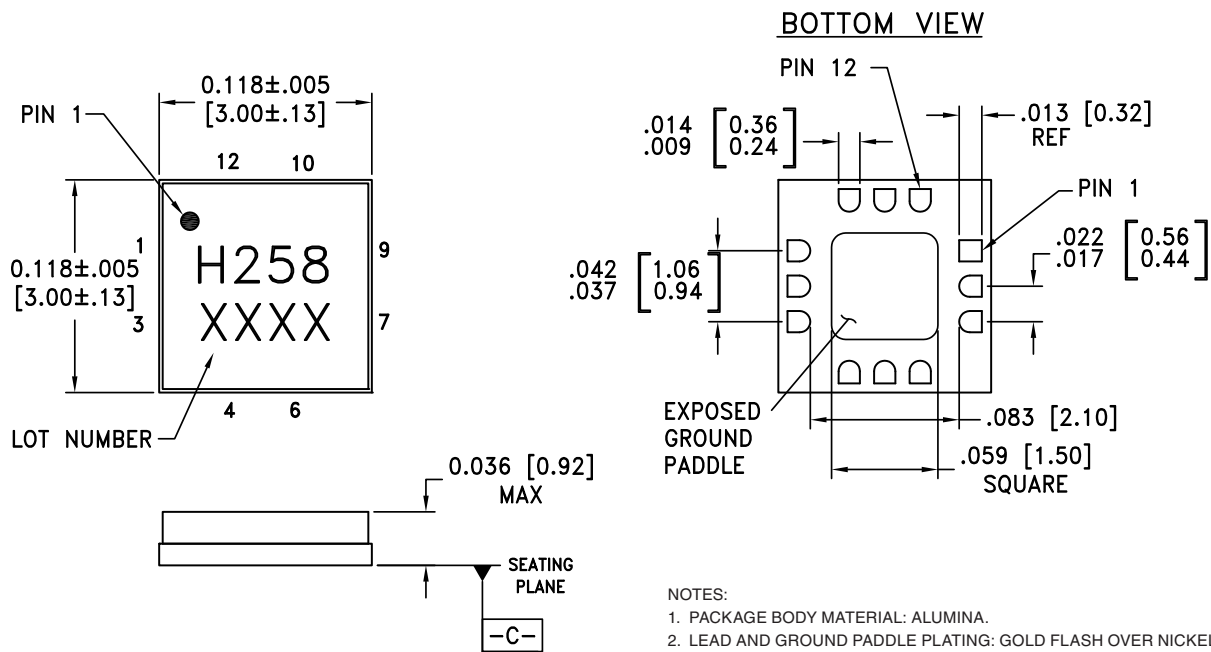

- NOTES:
1. PACKAGE BODY MATERIAL: ALUMINA.
 2. LEAD AND GROUND PADDLE PLATING: GOLD FLASH OVER NICKEL.
 3. DIMENSIONS ARE IN INCHES (MILLIMETERS).
 4. LEAD SPACING TOLERANCE IS NON-CUMULATIVE.
 5. CHARACTERS TO BE HELVETICA MEDIUM, .025 HIGH, BLACK INK, OR LASER MARK LOCATED APPROX. AS SHOWN.
 6. PACKAGE WARP SHALL NOT EXCEED 0.05MM DATUM - C -
 7. ALL GROUND LEADS AND GROUND PADDLE MUST BE SOLDERED TO PCB RF GROUND.

Package Information

Part Number	Package Body Material	Lead Finish	MSL Rating	Package Marking ^[2]
HMC258LC3B	Alumina, White	Gold over Nickel	MSL3 ^[1]	H258 XXXX

[1] Max peak reflow temperature of 260 °C

[2] 4-Digit lot number XXXX

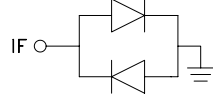
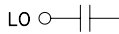
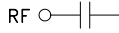

**GaAs MMIC SUB-HARMONIC
SMT MIXER, 14.5 - 19.5 GHz**
Pin Description

Pin Number	Function	Description	Interface Schematic
1, 4, 6, 10, 12	GND	Must be soldered to PCB RF ground.	
2	IF	IF Port. This pin is DC coupled and should be DC blocked externally using a series capacitor whose value has been chosen to pass the necessary IF frequency range. Any applied DC voltage to this pin will result in die non-function and possible die failure.	
3	Vdd	Power Supply for the LO Amplifier. An external RF bypass capacitor of 100 - 330 pF is required as close to the package as possible.	
5	LO	LO Port. This pin is AC coupled and matched to 50 Ohms.	
7 - 9	N/C	This pin may be connected to the housing ground or left unconnected.	
11	RF	RF Port. This pin is AC coupled and matched to 50 Ohms.	

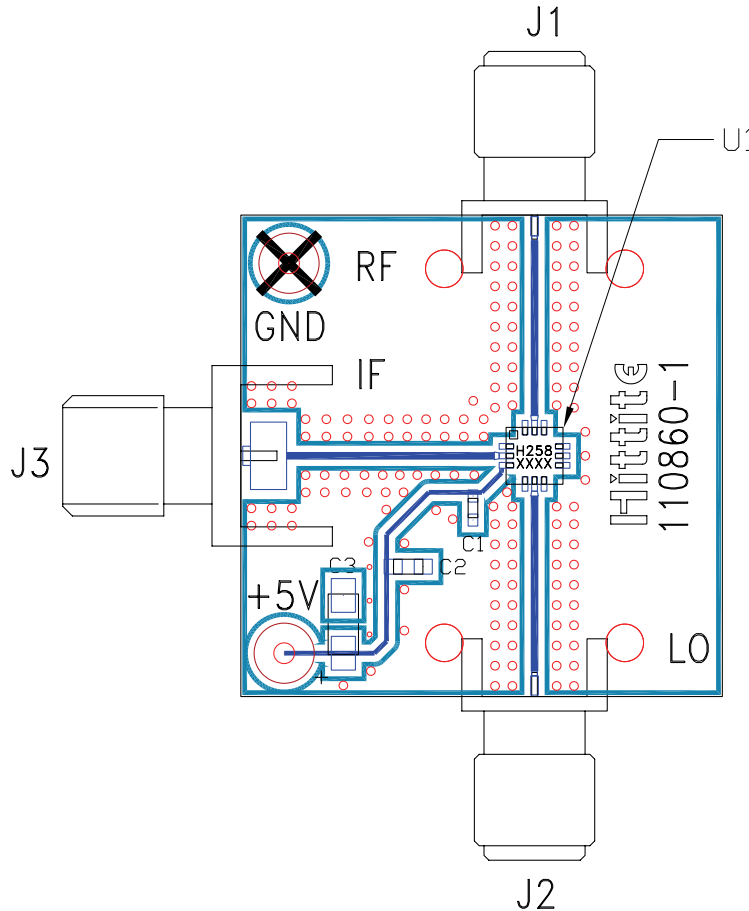

**GaAs MMIC SUB-HARMONIC
SMT MIXER, 14.5 - 19.5 GHz**

Evaluation PCB



List of Materials for Evaluation PCB 110862 [1]

Item	Description
J1, J2	SRI SMA Connector
J3	Johnson SMA Connector
C1	100pF Capacitor, 0402 Pkg.
C2	1000pF Capacitor, 0603 Pkg.
C3	2.2 μ F
U1	HMC258LC3B Mixer
PCB [2]	110860 Evaluation PCB

[1] Reference this number when ordering complete evaluation PCB

[2] Circuit Board Material: Rogers 4350

The circuit board used in this application should use RF circuit design techniques. Signal lines should have 50 Ohm impedance while the package ground leads and exposed paddle should be connected directly to the ground plane similar to that shown. A sufficient number of via holes should be used to connect the top and bottom ground planes. The evaluation board should be mounted to an appropriate heat sink. The evaluation circuit board shown is available from Hittite upon request.