

CXA-L0524-NJL

Non-dimming/Connector Type

■ Features

- 1 output
- UL60950 approved
- Applicable panel size*: 3 to 15 inches
- In the high-voltage generator(a terminal and a pattern), an anti-dust measure by silicone application is taken.
(Notice) Applicable panel size becomes a standard.

■ Applications



CXA-L0524-NJL Specifications (Please refer to each specification before use)

Electrical Characteristics

Item	Unit	Symbol	Specification			Condition			Remark
			min	typ	max	Vin(V)	Ta(°C)	RL(kΩ)	
Output Current	mArms	Iout	4.5	5.0	5.5	24±0.24	23±5	120	
			4.0	5.0	6.0	24±1.2	0 to +60	110 to 130	
Input Current	A	Iin	-	0.15	0.25	24±1.2	0 to +60	110 to 130	
Frequency	kHz	Freq	26	32	38	24±1.2	0 to +60	110 to 130	
Open Circuit Voltage	Vrms	Vopen	1400	1500	-	24±1.2	0 to +60	∞	Open load

Other Specifications

Dimming Function		No
Operating Temperature	°C	0 to +60
Storage Temperature	°C	-30 to +85
Operating Humidity Ratio	RH%	95Max
Safety Standard		UL60950
Weight	g	11
Dimensions(WxDxH)	mm	80.5x20.5x8 (*1)
Fused Input		Yes
Remote ON / OFF		No
Alarm Signal Function		No
Shutdown Function		No
Silicone Coating on High Voltage Area		Yes

(*1) These dimensions are indicated the maximum.

■ Conformity to RoHS Directive

This means that, in conformity with EU Directive 2002/95/EC, lead, cadmium, mercury, hexavalent chromium, and specific bromine-based flame retardants, PBB and PBDE, have not been used, except for exempted applications.

Outline Drawing

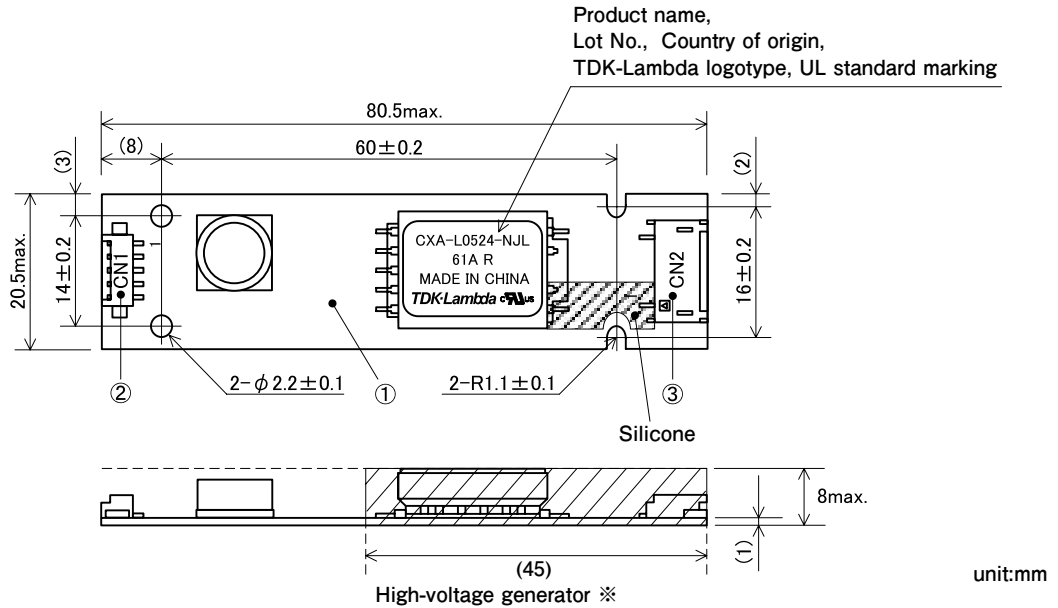

High-voltage generator ※
(The entire surface within a range of 45mm away from the end of the basein)

※From high-voltage generator, please secure space distance more than 3mm in top and bottom right and left.

Connector

Connector number	Part number	Model	Quantity	Remarks	Recommended applicable connector
①	Printed circuit board PCB	Composite (CEM-3)	1	UL94V-0 t=1.0	—
②	Input connector CN1	53261-0571	1	Molex Inc.	51021-0500
③	Output connector CN2	SM02 (8.0) B-BHS-1-TB (LF) (SN)	1	JST Mfg. Co., Ltd.	BHR-03VS-1

Terminal Numbers And Functions

Input side CN1

Terminal number	Symbol	Rated voltage
CN1-1	V _{in}	24V
CN1-2	GND	0V
CN1-3	N.C.	—
CN1-4		
CN1-5		

Output side CN2

Terminal number	Symbol	Rated voltage
CN2-1	V _{HIGH1}	750Vrms
CN2-2	N.C.	—
CN2-3	V _{HIGH2}	750Vrms

※The output is floating.
Both CN2-1 and CN2-3 become high voltage.

Connections

