

### FEATURES

- UL60950 recognised for 250Vrms basic insulation
- ANSI/AAMI ES60601-1, 1 MOOP recognised
- RoHS compliant
- SMD compatible
- +6V, -6V unregulated and +5V regulated
- TTL signal isolator
- 2 outgoing 2 incoming data lines
- 25Mbps data rate
- Industrial temperature range -40°C to +95°C
- Tested at 1500Vac RMS 'Hi Pot Test'

### PRODUCT OVERVIEW

The NMTTLD6S5MC is a low power electrically isolated TTL data transmission device. No external components are needed as a single 5V supply powers all functions either side of the isolation boundary. NMTTLD6S5MC also provides a regulated 5V, unregulated 6V and -6V isolated supply's for system use.

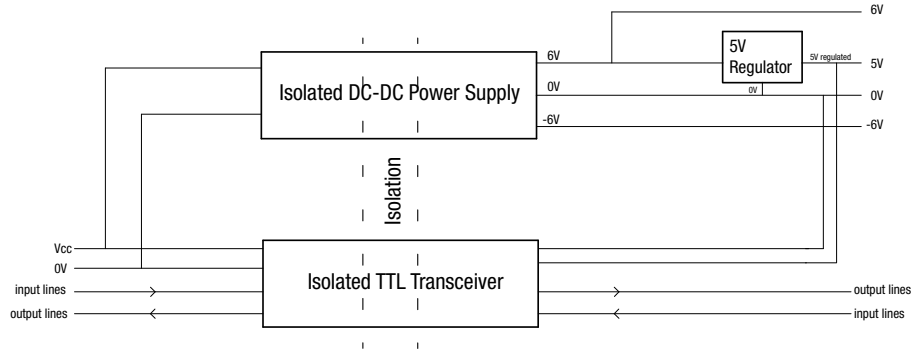

### SELECTION GUIDE

To be discontinued	
Order Code <sup>1</sup>	NMTTLD6S5MC

### MODULE CHARACTERISTICS

#### SWITCHING CHARACTERISTICS

Parameter	Test conditions	Min.	Typ.	Max.	Units	Symbol
Pulse width	Within PWD limit	40			ns	PW
Date rate	Within PWD limit			25	Mbps	
Propagation delay	50% input to 50% output		25	33	ns	t <sub>PHL</sub> , t <sub>PLH</sub>
Pulse width distortion	t <sub>PLH</sub> - t <sub>PHL</sub>			3	ns	PWD
Change vs. Temperature			3		ps/°C	
Propagation delay skew	Between any two units			17	ns	t <sub>PSK</sub>
Codirectional, Channel matching				5	ns	t <sub>PSKCD</sub>
Opposing direction, Channel matching				7	ns	t <sub>PSKOD</sub>
Jitter			2		ns	

#### ELECTRICAL CHARACTERISTICS

Parameter	Test conditions	Min.	Typ.	Max.	Units	Symbol
Supply voltage		4.5	5.0	5.5	V	V <sub>in</sub>
Logic high (Input)	= 3.5 For secondary	0.7V <sub>in</sub>			V	V <sub>IH</sub>
Logic low (Input)	= 1.5 for secondary			0.3V <sub>in</sub>	V	V <sub>IL</sub>
Logic high (Output)	I <sub>ox</sub> = -20µA, V <sub>ix</sub> = V <sub>IxH</sub> = 4.9 for secondary	V <sub>in</sub> - 0.1	5.0		V	V <sub>OH</sub>
	I <sub>ox</sub> = -4mA, V <sub>ix</sub> = V <sub>IxH</sub> = 4.6 for secondary	V <sub>in</sub> - 0.4	4.8		V	V <sub>OH</sub>



For full details go to  
[www.murata-ps.com/rohs](http://www.murata-ps.com/rohs)



1. Components are supplied in tape and reel packaging, please refer to package specification section. Orderable part numbers are NMTTLD6S5MC-R7 (80 pieces per reel), or NMTTLD6S5MC-R13 (350 pieces per reel).

All specifications typical at TA=25°C, nominal input voltage and rated output current unless otherwise specified.

ELECTRICAL CHARACTERISTICS (Continued)						
Parameter	Test conditions	Min.	Typ.	Max.	Units	Symbol
Logic low (Output)	$I_{Ox} = 20\mu A, V_{Ix} = V_{IxH} = 4.9$ for secondary		0.0	0.1	V	$V_{OL}$
	$I_{Ox} = 4mA, V_{Ix} = V_{IxH} = 4.6$ for secondary		0.2	0.4	V	$V_{OL}$
Input current per channel	$0V \leq V_{Ix} \leq 5V, 0V \leq V_{CTRLx} \leq 5V$	-10	+0.01	+10	$\mu A$	$I_I$
Quiescent Supply Current						
Regulator input side			0.5	0.6	mA	$I_{DDL} (Q)$
I/O Input			0.027	0.05	mA	$I_{DDL} (Q)$
Regulator output side			1.26	1.7	mA	$I_{DDO} (Q)$
I/O Output			0.031	0.1	mA	$I_{DDOL} (Q)$
Dynamic Supply Current						
Regulator input side			0.07		mA/Mbps	$I_{DDL} (D)$
I/O Input			0.9		$\mu A/Mbps$	$I_{DDL} (D)$
Regulator output side			0.01		mA/Mbps	$I_{DDO} (D)$
I/O Output			0.02		mA/Mbps	$I_{DDOL} (D)$
AC Specifications						
Output rise/Fall time	10% to 90%		2.5		ns	
Common-mode transient immunity	$V_{Ix} = V_{DDL}, V_{CM} = 1000V$ , transient magnitude = 800V	25	35		kV/ $\mu s$	CM
Refresh period			1.66		$\mu s$	tr

### DC-DC CHARACTERISTICS

INPUT CHARACTERISTICS						
Parameter	Conditions	Min.	Typ.	Max.	Units	
Voltage range	Continuous operation	4.5	5	5.5	V	
Input Current	5V input		280		mA	
Input reflected ripple current	5V input		6		mA p-p	

OUTPUT CHARACTERISTICS						
Parameter	Conditions	Min.	Typ.	Max.	Units	
Line regulation	Low line to high line		1.1	1.3	%%	
Load Regulation	All output types		5	10	%	
Ripple and noise			25	50	mV p-p	
Power	5V Regulated			0.4	W	
	Total available power across all outputs			0.8		

TEMPERATURE CHARACTERISTICS						
Parameter	Conditions	Min.	Typ.	Max.	Units	
Operation	See derating curve	-40		95	°C	
Storage		-50		125		
Product temperature rise above ambient	Measured in the isolation barrier		20			

ISOLATION CHARACTERISTICS						
Parameter	Conditions	Min.	Typ.	Max.	Units	
Isolation capacitance			5		pF	
Isolation test voltage	Production tested for 1 second	1500			VAC rms	
	Qualification tested for 1 minute	1500			VAC rms	
Resistance	$V_{iso} = 1kVDC$	5			G $\Omega$	

GENERAL CHARACTERISTICS					
Parameter	Conditions	Min.	Typ.	Max.	Units
MTTF - nominal input voltage at full load	MIL-HDBK-217 FN2		4000		kHrs
	Telcordia SR-332		20000		kHrs
Switching frequency			90		kHz

ABSOLUTE MAXIMUM RATINGS		
Parameter	Conditions	Value
Input voltage		6V
Logic terminal voltages		-0.5V to $V_{in}$ +0.5V

**TECHNICAL NOTES****ISOLATION VOLTAGE**

'Hi Pot Test', 'Flash Tested', 'Withstand Voltage', 'Proof Voltage', 'Dielectric Withstand Voltage' & 'Isolation Test Voltage' are all terms that relate to the same thing, a test voltage, applied for a specified time, across a component designed to provide electrical isolation, to verify the integrity of that isolation.

Murata Power Solutions NMTTLD6S5MC data isolator is 100% production tested at 1.5kVAC rms for 1 second and have been qualification tested at 1.5kVAC rms for 1 minute.

The NMTTLD6S5MC has been recognised by Underwriters Laboratory to 250 Vrms basic Insulation.

**REPEATED HIGH-VOLTAGE ISOLATION TESTING**

It is well known that repeated high-voltage isolation testing of a barrier component can actually degrade isolation capability, to a lesser or greater degree depending on materials, construction and environment. We therefore strongly advise against repeated high voltage isolation testing, but if it is absolutely required, that the voltage be reduced by 20% from specified test voltage.

**SAFETY APPROVAL****ANSI/AAMI ES60601-1**

The NMTTLD6S5MC has been recognised to ANSI/AAMI ES60601-1 and provides 1 MOOP (Means Of Operator Protection) based upon a working voltage of 250 Vrms max, between Primary and Secondary.

**UL 60950**

The NMTTLD6S5MC has been recognised by Underwriters Laboratory (UL) to UL 60950 for basic insulation to a working voltage of 250Vrms.

Creepage is 2.5mm and clearance is 2mm.

**FUSING**

The NMTTLD6S5MC is not internally fused so to meet the requirements of UL an anti-surge input line fuse should always be used with ratings as defined below.

NMTTL - 1A

All fuses should be UL recognised and rated to at least the maximum allowable DC input voltage.

**RoHS COMPLIANCE, MSL AND PSL INFORMATION**

The NMTTLD6S5MC is compatible with Pb-Free soldering systems and is also backward compatible with Sn/Pb soldering systems. The NMTTLD6S5MC has a process, moisture, and reflow sensitivity classification of MSL2 PSL R7F as defined in J-STD-020 and J-STD-075. This translates to: MSL2 = 1 year floor life, PSL R7F = Peak reflow temperature 245°C with a limitation on the time above liquidus (217°C) which for this series is 90sec max. Please refer to [application notes](#) for further information. The pin termination finish on this product series is Gold with Nickel Pre-plate.

**APPLICATION NOTES**

**Short Circuit Performance**

The NMTTLD6S5MC offers short circuit protection at low ambient temperatures from -40°C to the temperatures shown in the below graph, when the output power lines are shorted together or to zero volts out.

Short circuit of data lines are undefined, all data lines should be properly used or terminated via a high impedance to their respective ground

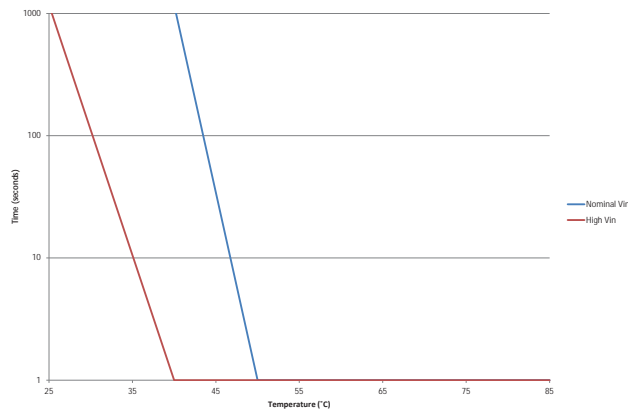

**Capacitive Loading & Start Up**

Typical start up times for this series, with a typical input voltage rise time of 2.2µs and output capacitance of 10µF, are shown in the table below. The product series will start into a capacitance of 47µF with an increased start time of 4.6ms.

Start-up time	
ms	
NMTTLD6S5MC	1.6

Typical Start-Up Wave Form

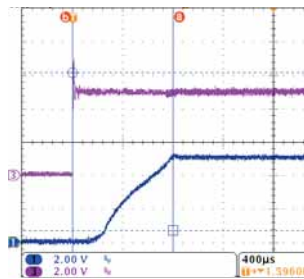

**Minimum load**

The minimum load to meet datasheet specification is 10% of the full rated load across the specified input voltage range. Lower than 10% minimum loading will result in an increase in output voltage, which may rise to typically double the specified output voltage if the output load falls to less than 5%.

**APPLICATION NOTES (Continued)**

Circuit diagram

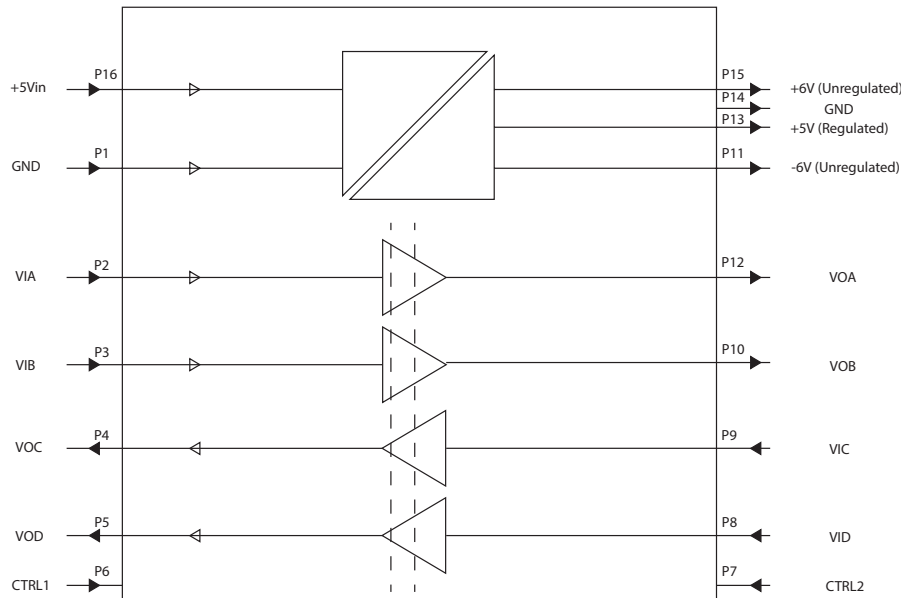

**Detailed Pin Connections**

Pin	Function	Description
1	GND	Non-isolated input ground
2	VIA	Logic input A, non-isolated 5V TTL
3	VIB	Logic input B, non-isolated 5V TTL
4	VOC	Logic output C, non-isolated 5V TTL
5	VOB	Logic output B, non-isolated 5V TTL
6	CTRL1	Select non-isolated side output default level Low = default output low. High = default output high
7	CTRL2	Select isolated side output default level Low = default output low. High = default output high
8	VID	Logic input D, isolated 5V TTL
9	VIC	Logic input C, isolated 5V TTL
10	VOB	Logic output B, isolated 5V TTL
11	-6V	Isolated -6V output, non-regulated Please see note 1 for current rating
12	VOA	Logic output A, isolated 5V TTL
13	5V REG	+5V regulated output, max power 400mW Please see note 1 for current rating
14	GND	Isolated ground
15	+6V	Isolated +6V output, non-regulated Please see note 1 for power rating
16	5Vin	+5V non-isolated input

Note 1: The total isolated power rating across all outputs is 800mW, +5V regulated output max power is 400mW

**Default control (CTRL-1, CTRL-2)**

CTRL-1: Default control input for non-isolated side, connect CTRL-1 (pin 6) to VCC (pin 16) to set the output VOC (pin 4) & VOD (pin 5) to default logic high.

CTRL-1: Default control input for non-isolated side, connect CTRL-1 (pin 6) to GND (pin 1) to set the output VOC (pin 4) & VOD (pin 5) to default logic low.

CTRL-2: Default control input for isolated side, connect CTRL-2 (pin 7) to +5V REG (pin 13) to set the output VOB (pin 10) & VOA (pin 12) to default logic high

CTRL-2: Default control input for isolated side, connect CTRL-2 (pin 7) to GND (pin 14) to set the output VOB (pin 10) & VOA (pin 12) to default logic low

NOTE: The default state of the outputs whilst the inputs are either not powered or disconnected is determined by the state in which the CTRL pins have been set up.

**TEMPERATURE DERATING GRAPH**

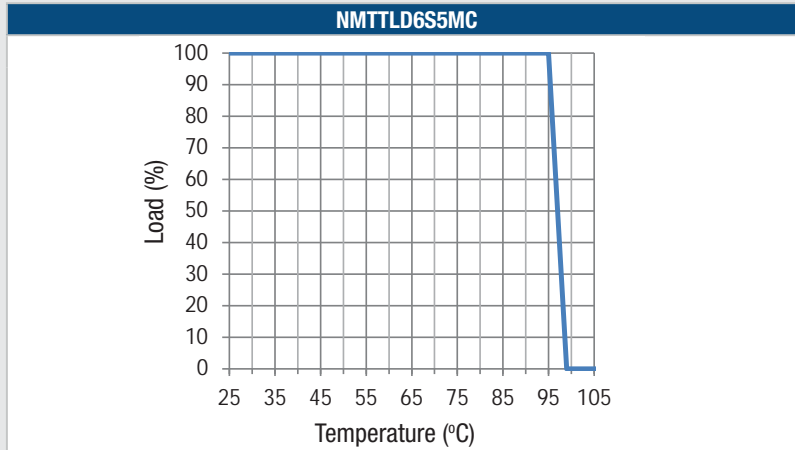

**EFFICIENCY GRAPH**

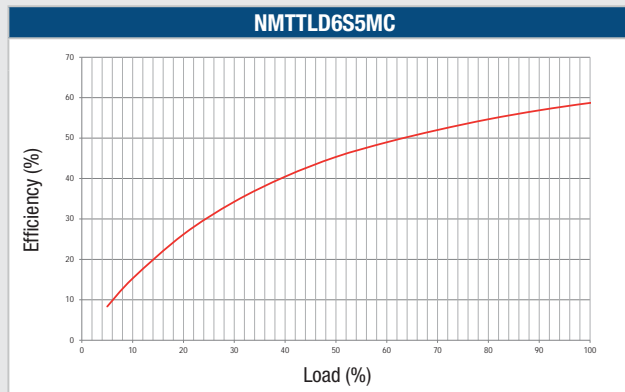

**TOLERANCE ENVELOPE**

The voltage tolerance envelope show typical load regulation characteristics for the NMTTLD6S5MC. The tolerance envelope is the maximum output voltage variation due to changes in output loading and set point accuracy.

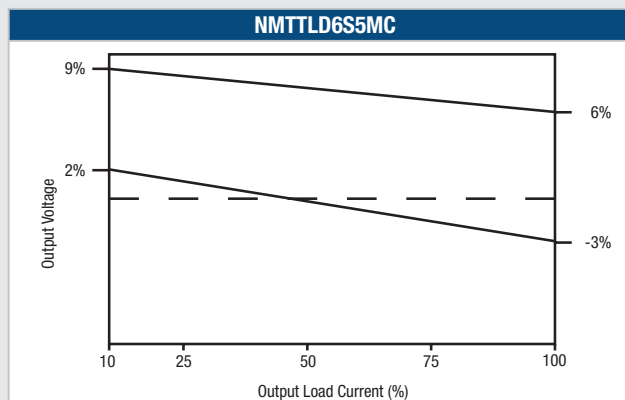

**EMC FILTERING AND SPECTRA**

**FILTERING**

The following filter circuit and table shows the input capacitor and input inductor typically required to meet EN55022 Curve A and B, Quasi-Peak EMC limit, as shown in the following plot. The following plot shows positive and negative quasi peak and CISPR22 Average Limit A (pink line) and CISPR22 Average Limit B (blue line) adherence limits.

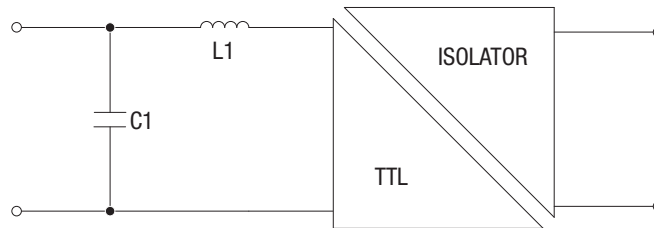

**C1** 63V Polycarbonate capacitor

Part Number	Inductor		Capacitor
	L1	Murata Part Number	C1
NMTTLD6S5MC	22µH	23220C	2.2µF

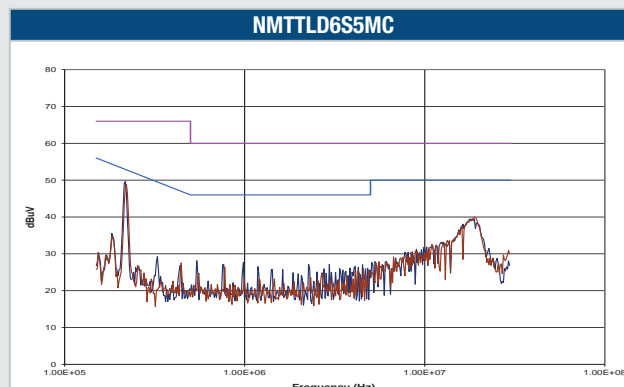



**PACKAGE SPECIFICATIONS**

**MECHANICAL DIMENSIONS**

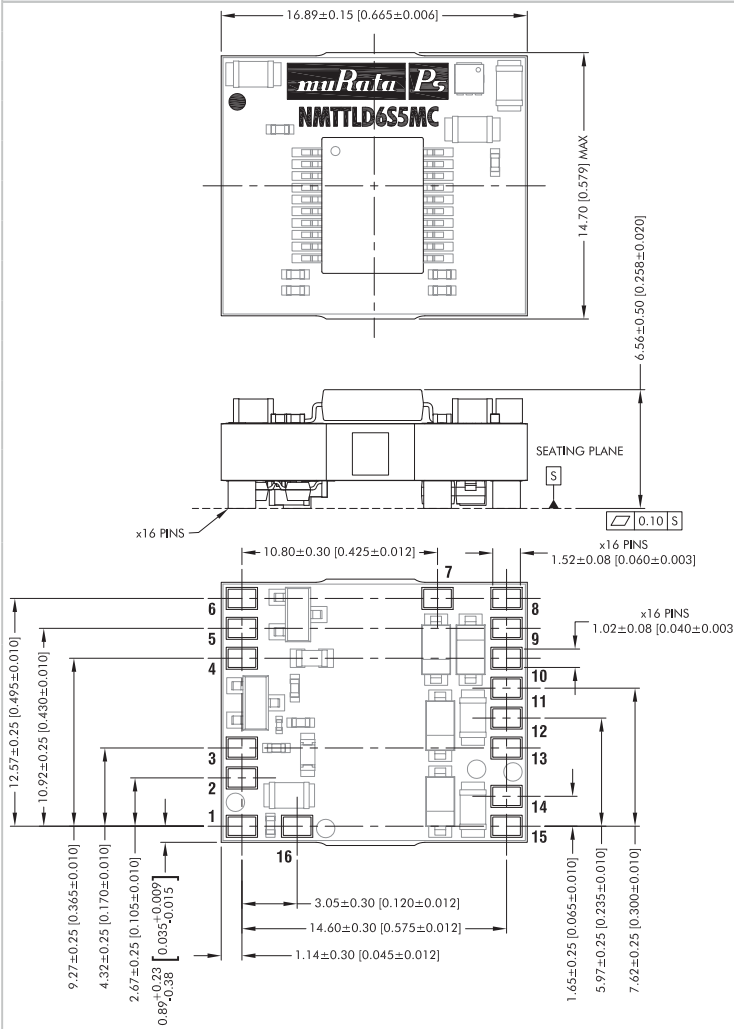

All dimensions in mm (inches). Controlling dimensions in mm.  
Component layout is shown for reference only.

Weight: 2.5g

**PIN CONNECTIONS**

Pin	Function
1	GND
2	VIA
3	VIB
4	VOC
5	VOD
6	CTRL1
7	CTRL2
8	VID
9	VIC
10	VOB
11	-6V
12	VOA
13	5V REG
14	GND
15	+6V
16	5V IN

**RECOMMENDED FOOTPRINT DETAILS**

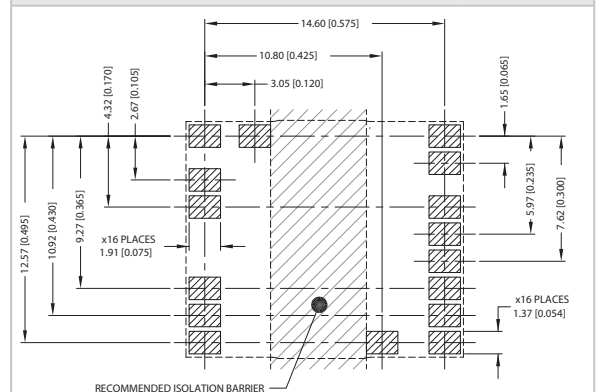

RECOMMENDED ISOLATION BARRIER

**TAPE & REEL SPECIFICATIONS**

**REEL OUTLINE DIMENSIONS**

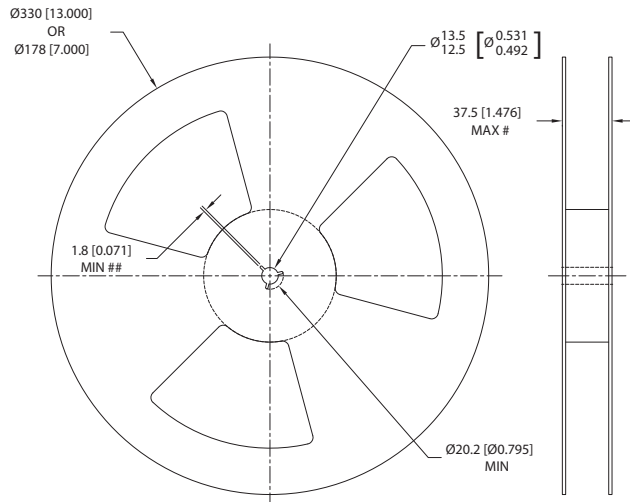

Tape & Reel specifications shall conform with current EIA-481 standard  
 Unless otherwise stated all dimensions in mm(inches)  
 Controlling dimension is mm  
 # Measured at hub  
 ## Six equi-spaced slots on 180mm/7" reel

**REEL PACKAGING DETAILS**

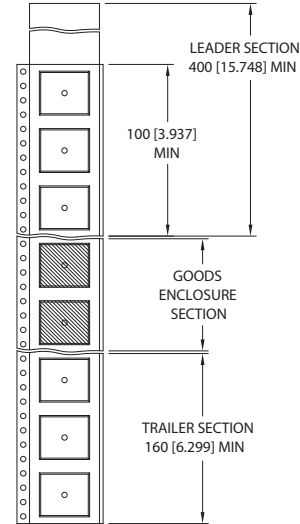

Carrier tape pockets shown are illustrative only - Refer to carrier tape diagram for actual pocket details.

Reel Quantity: 7" - 80 or 13" - 350

**TAPE OUTLINE DIMENSIONS**

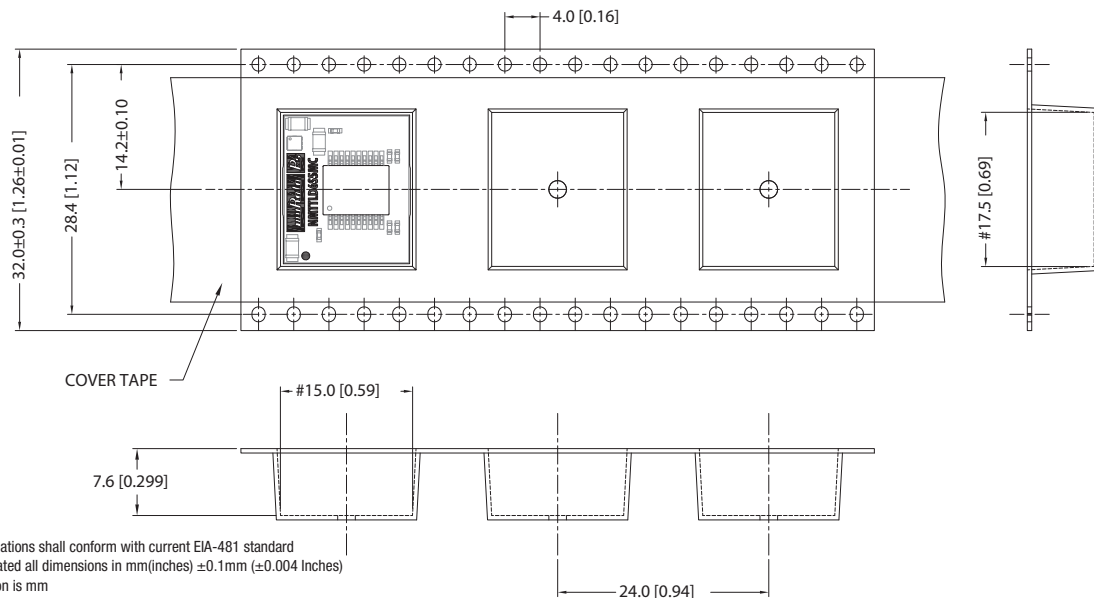

Tape & Reel specifications shall conform with current EIA-481 standard  
 Unless otherwise stated all dimensions in mm(inches) ±0.1mm (±0.004 Inches)  
 Controlling dimension is mm  
 Components shall be orientated within the carrier tape as indicated  
 # Measured on a plane 0.3mm above the bottom pocket

**DISCLAIMER**

Unless otherwise stated in the datasheet, all products are designed for standard commercial and industrial applications and NOT for safety-critical and/or life-critical applications.

Particularly for safety-critical and/or life-critical applications, i.e. applications that may directly endanger or cause the loss of life, inflict bodily harm and/or loss or severe damage to equipment/property, and severely harm the environment, a prior explicit written approval from Murata is strictly required. Any use of Murata standard products for any safety-critical, life-critical or any related applications without any prior explicit written approval from Murata shall be deemed unauthorised use.

These applications include but are not limited to:

- Aircraft equipment
- Aerospace equipment
- Undersea equipment
- Power plant control equipment
- Medical equipment
- Transportation equipment ( automobiles, trains, ships, etc.)
- Traffic signal equipment
- Disaster prevention / crime prevention equipment
- Data Processing equipment

Murata makes no express or implied warranty, representation, or guarantee of suitability, fitness for any particular use/purpose and/or compatibility with any application or device of the buyer, nor does Murata assume any liability whatsoever arising out of unauthorised use of any Murata product for the application of the buyer. The suitability, fitness for any particular use/purpose and/or compatibility of Murata product with any application or device of the buyer remain to be the responsibility and liability of the buyer.

Buyer represents and agrees that it has all the necessary expertise to create and implement safeguards that anticipate dangerous consequences of failures, monitor failures and their consequences, lessen the likelihood of failures that might cause harm, and take appropriate remedial actions. Buyer will fully indemnify and hold Murata, its affiliated companies, and its representatives harmless against any damages arising out of unauthorised use of any Murata products in any safety-critical and/or life-critical applications.

Remark: Murata in this section refers to Murata Manufacturing Company and its affiliated companies worldwide including, but not limited to, Murata Power Solutions.



This product is subject to the following [operating requirements](#) and the [Life and Safety Critical Application Sales Policy](#):

Refer to: <https://www.murata.com/en-eu/products/power/requirements>

Murata Power Solutions (Milton Keynes) Ltd. makes no representation that the use of its products in the circuits described herein, or the use of other technical information contained herein, will not infringe upon existing or future patent rights. The descriptions contained herein do not imply the granting of licenses to make, use, or sell equipment constructed in accordance therewith. Specifications are subject to change without notice.  
© 2021 Murata Power Solutions (Milton Keynes) Ltd.