

SF2190B

**138 MHz
SAW Filter**

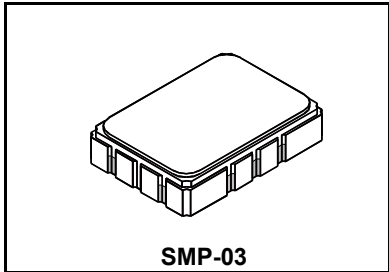

- **Small Size**
- **Hermetic 5 X 7 mm Surface-mount Case**
- **Differential Input/Output**
- **Complies with Directive 2002/95/EC (RoHS)**



Absolute Maximum Ratings

Rating	Value	Units
Maximum Incident Power in Passband	+10	dBm
Maximum DC Voltage Between any Two Terminals	3	VDC
Operating Temperature Range	-40 to +85	°C
Storage Temperature Range in Tape and Reel	-40 to +85	°C
Maximum Soldering Profile	265°C for 10 s	

Electrical Characteristics

Characteristic	Sym	Notes	Min	Typ	Max	Units
Center Frequency	F_C			138		MHz
Insertion Loss	IL			18.8	21.0	dB
1 dB Bandwidth			60	63		MHz
3 dB Bandwidth				65.4		MHz
Amplitude Ripple Across 1 dB Bandwidth				0.6	1.2	dB _{p-p}
Upper -35 dB Band Edge				176	179	MHz
Lower -35 dB Band Edge			97	101		MHz
Ultimate Rejection			35	40		dB
Temperature Coefficient				-72		ppm/°C
Source Impedance, Balanced				50		ohm
Load Impedance, Balanced				50		ohm

Case Style	SMP-03 5 X 7 mm Nominal Footprint
Lid Symbolization (Y=year, WW=week, S=shift) See note 3	RFM SF2190B YWWS



CAUTION: Electrostatic Sensitive Device. Observe precautions for handling.

NOTES:

1. Unless noted otherwise, all specifications apply over the operating temperature range with filter soldered to the specified demonstration board with impedance matching to 50 Ω and measured with 50 Ω network analyzer. A dB offset exists for RFM because of the loss introduced by using transformers on the Input and Output.
2. Rejection is measured as attenuation below the minimum IL point in the passband. Rejection in final user application is dependent on PCB layout and external impedance matching design. See Application Note No. 42 for details.
3. "LRIP" or "L" after the part number indicates "low rate initial production" and "ENG" or "E" indicates "engineering prototypes."
4. The design, manufacturing process, and specifications of this filter are subject to change.
5. Either Port 1 or Port 2 may be used for either input or output in the design. However, impedances and impedance matching may vary between Port 1 and Port 2, so that the filter must always be installed in one direction per the circuit design.
6. US and international patents may apply.
7. Murata, stylized Murata logo, and Murata N.A., Inc. are registered trademarks of Murata Manufacturing Co., Ltd.

SF2190B Response, 38 to 238 MHz

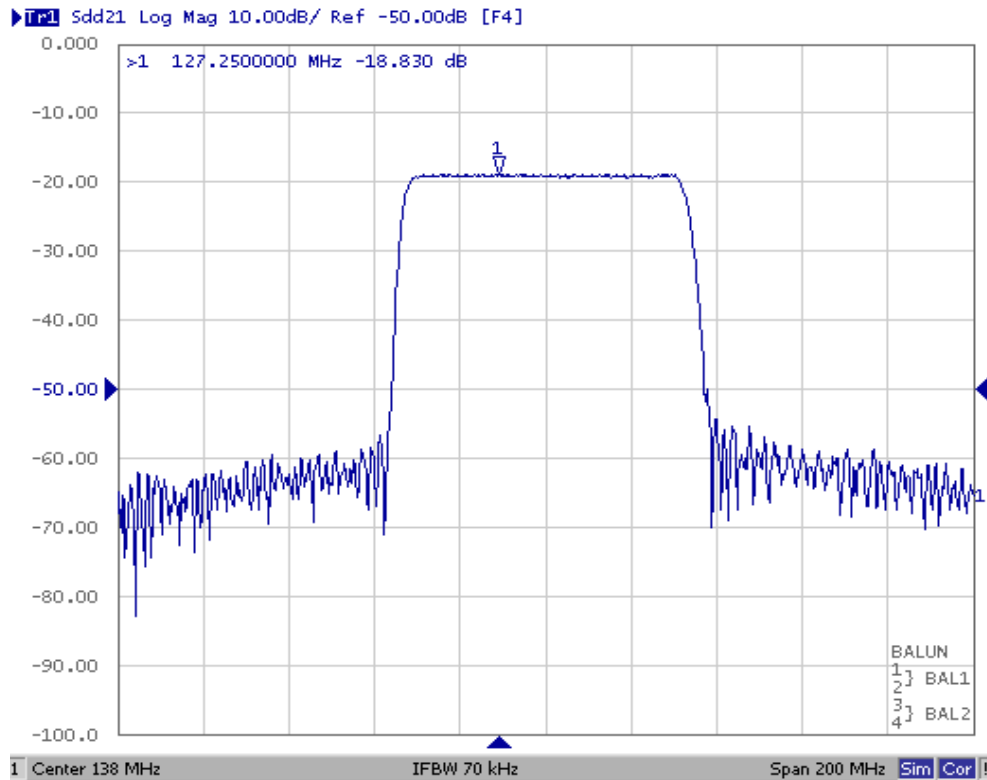

SF2190B Passband Response

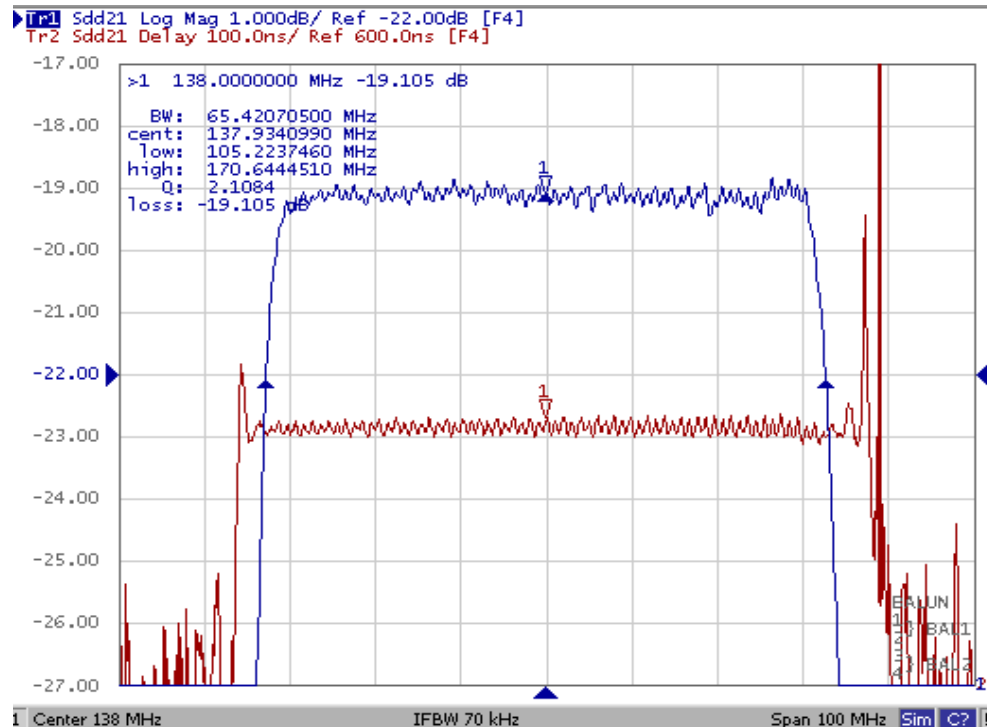

SF2190B Response, 300 kHz to 600 MHz

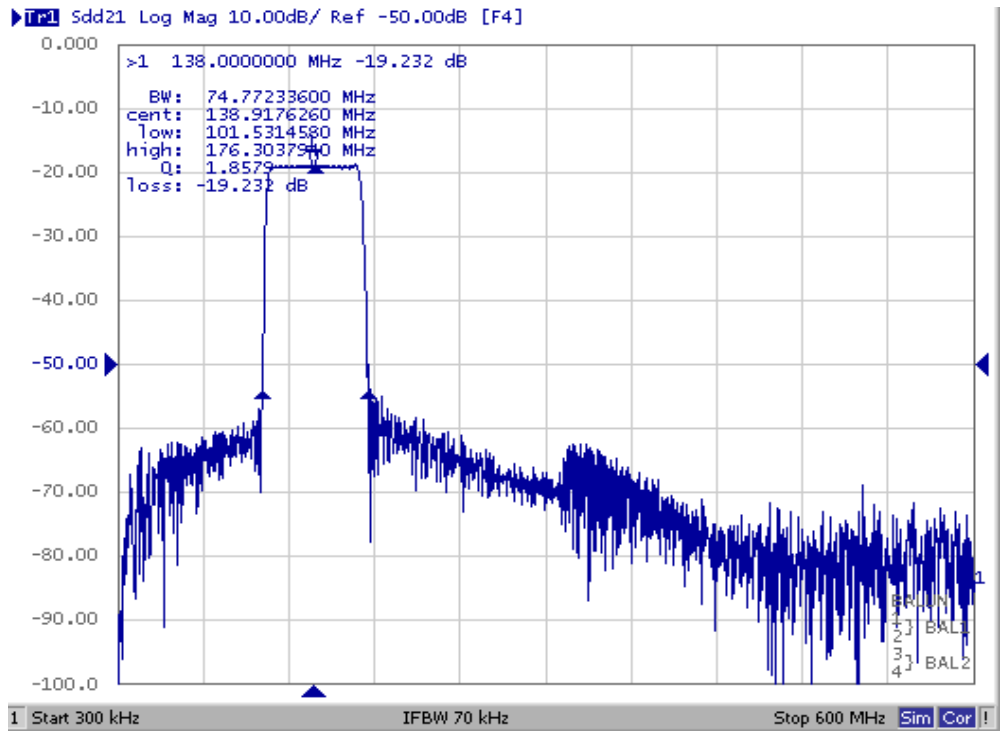

10-Terminal Ceramic Surface-Mount Case

5 x 7 mm Nominal Footprint

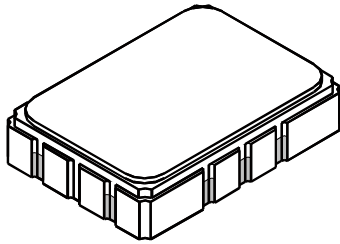

SMP-03 Package

Matching Network

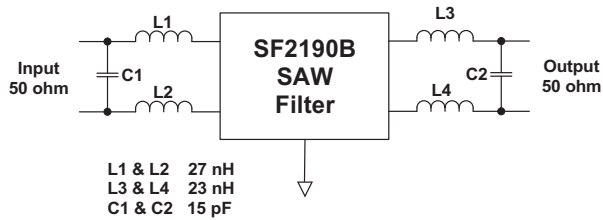

Case Dimensions

Dimension	mm			Inches		
	Min	Nom	Max	Min	Nom	Max
A	6.80	7.00	7.20	0.268	0.276	0.283
B	4.80	5.00	5.20	0.189	0.197	0.205
C		1.65	2.00		0.065	0.079
D		0.60			0.024	
E		2.54			0.100	
H		1.0			0.039	
J		5.00			0.197	
K		3.00			0.118	
P		1.27			0.050	

Electrical Connections

Connection		Terminals
Port 1	Balanced Input	10
	Balanced Input	1
Port 2	Balanced Output	5
	Balanced Output	6
Ground		All others

Case Materials

Materials	
Solder Pad Plating	0.3 to 1.0 μm Gold over 1.27 to 8.89 μm Nickel
Lid Plating	2.0 to 3.0 μm Nickel
Body	Al_2O_3 Ceramic
Pb Free	

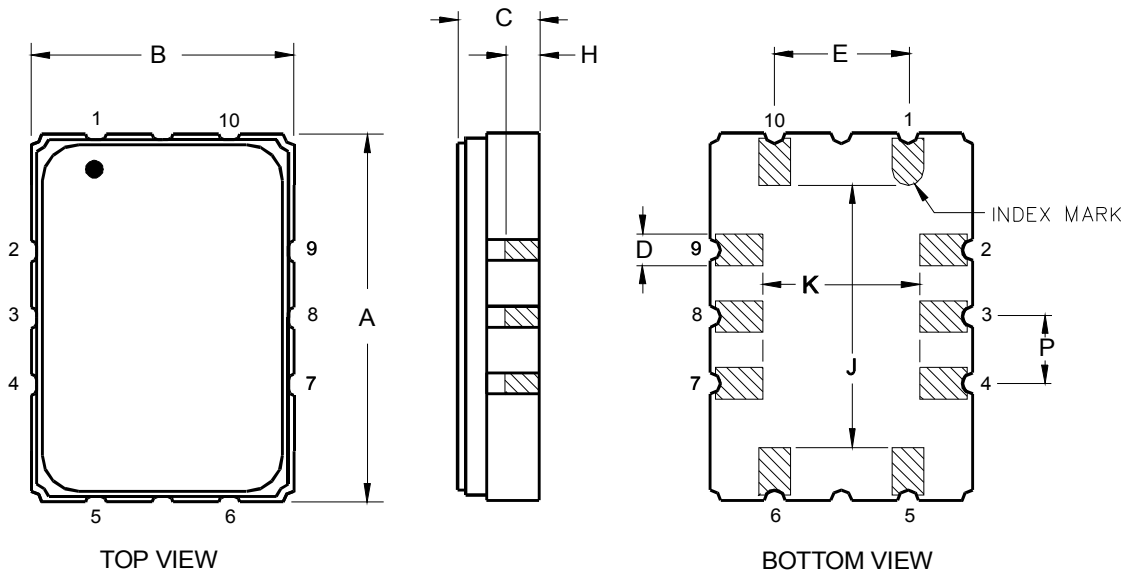

Tape and Reel Specifications

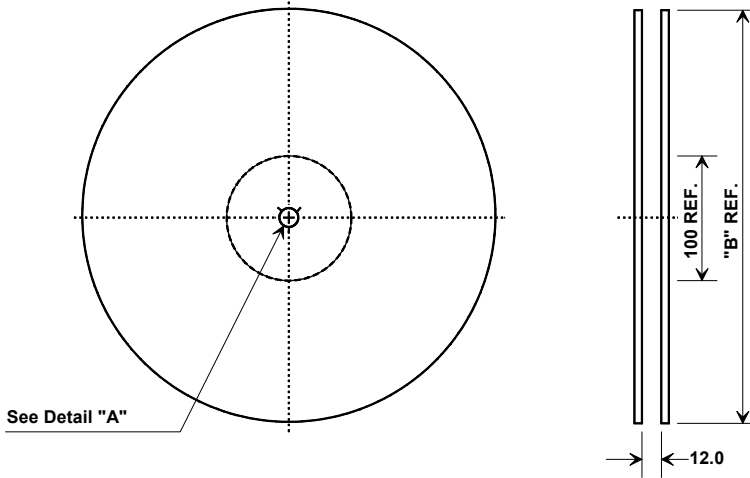

"B" Nominal Size		Quantity Per Reel
Inches	millimeters	
7	178	500
13	330	2000

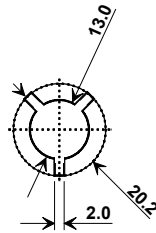

Component Orientation and Dimensions

Carrier Tape Dimensions	
Ao	9.4 mm
Bo	7.4 mm
Ko	2.0 mm
Pitch	8.0 mm
W	16.0 mm

