

CR2

■ Dimensions(mm)

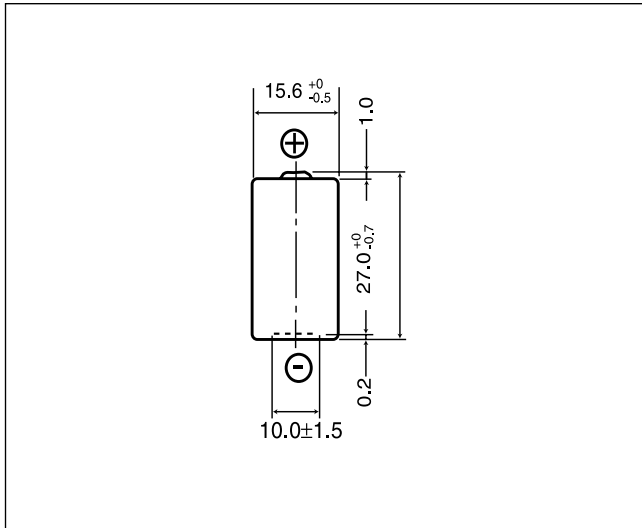

■ Specification

Nominal voltage(V)	3
Nominal capacity(mAh)	850
Continuous drain(mA)	20
Operating temperature(°C)	-40 to +70*

■ Discharge temperature characteristics

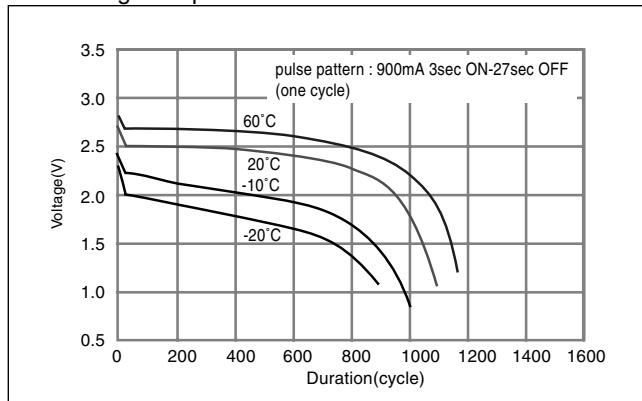

* Please consult Panasonic for use below and above -20°C to +60°C.

CR123A

■ Dimensions(mm)

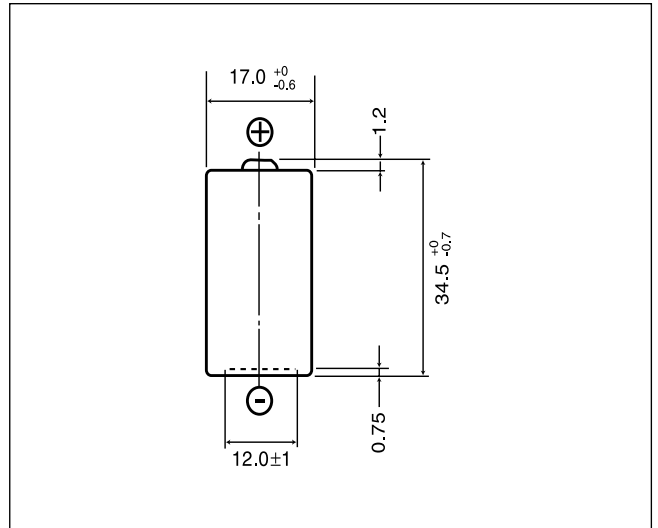

■ Specification

Nominal voltage(V)	3
Nominal capacity(mAh)	1,550
Continuous drain(mA)	20
Operating temperature(°C)	-40 to +70*

■ Discharge temperature characteristics

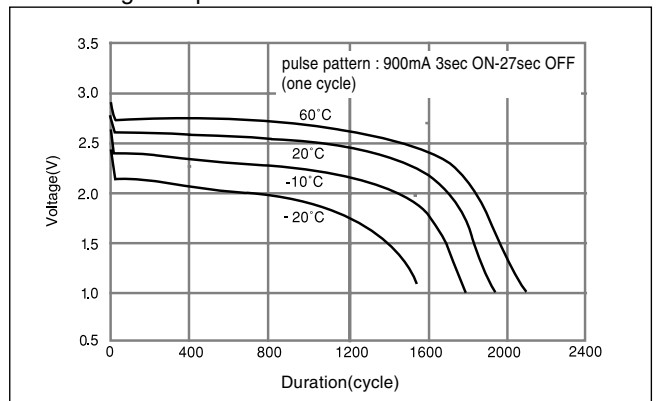

* Please consult Panasonic for use below and above -20°C to +60°C.