



GaAs MMIC ANALOG VARIABLE GAIN AMPLIFIER, 0.5 - 6.0 GHz

Typical Applications

The HMC972LP5E is ideal for:

- Cellular/3G Infrastructure
- WiBro / WiMAX / 4G
- Microwave Radio & VSAT
- Test Equipment and Sensors
- IF & RF Applications

Features

- Wide Gain Control Range: -35 to +15 dB
- High Output IP3: +28 dBm
- Positive Analog Control: 0 to +5V
- Can be configured with 1 or 2 Attenuators
- 32 Lead 5x5 mm SMT Package: 25 mm²

Functional Diagram

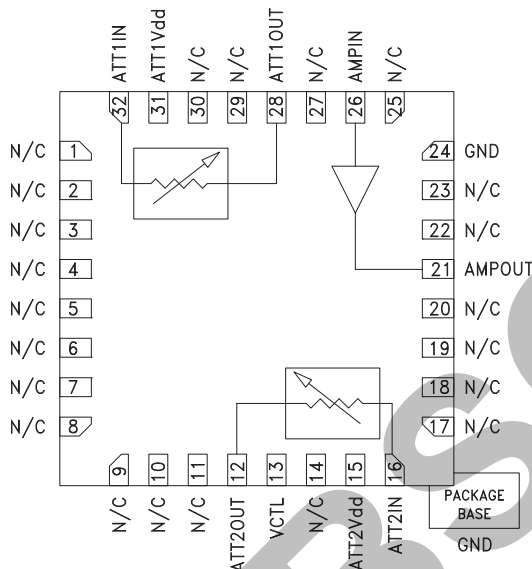

General Description

The HMC972LP5E is an analog controlled variable gain amplifier composed of two identical voltage variable attenuators in combination with an InGaP HBT gain block MMIC amplifier which operates from 0.5 to 6 GHz, and can be controlled to provide anywhere from 15 dB of gain to 35 dB of attenuation. The HMC972LP5E delivers noise figure of 7.5 dB in its maximum gain state, with output IP3 of up to +28 dBm. The HMC972LP5E is housed in a RoHS compliant 5x5 mm QFN leadless package, and requires no external matching components.

Electrical Specifications, $T_A = +25^\circ\text{C}$, 50 Ohm System, $V_{dd} = \text{ATT1Vdd} = \text{ATT2Vdd} = +5\text{V}$ [1]

| Parameter | Frequency | Min. | Typ. | Max. | Units |
|--|---------------|------|------|------|-------|
| Insertion Gain (Vctl = 0V) | 0.5 - 2.7 GHz | 10.5 | 13 | | dB |
| | 2.7 - 4.0 GHz | 6 | 9 | | dB |
| | 4.0 - 6.0 GHz | | 0 | | |
| Gain Control Range | 0.5 - 4.0 GHz | | 50 | | dB |
| | 4.0 - 6.0 GHz | | 42 | | |
| Input Return Loss (Vctl = 0V) | | | 12 | | dB |
| Output Return Loss (Vctl = 0V) | | | 10 | | dB |
| Output Power for 1dB Compression (Vctl = 0V) | 0.5 - 2.7 GHz | | 16 | | dBm |
| | 2.7 - 4.0 GHz | | 13 | | dBm |
| | 4.0 - 6.0 GHz | | 6 | | |
| Output Third Order Intercept Point (Two-Tone Output Power = 0 dBm Each Tone) (Vctl = 0V) | 0.5 - 2.7 GHz | | 29 | | dBm |
| | 2.7 - 4.0 GHz | | 26 | | dBm |
| | 4.0 - 6.0 GHz | | 20 | | |
| Noise Figure (Vctl = 0V) | | | 7.5 | | dB |
| I _{dd} | | 75 | 85 | 102 | mA |
| ATT1I _{dd} | | | 0.2 | 0.3 | mA |
| ATT2I _{dd} | | | 0.2 | 0.3 | mA |

[1] Unless otherwise noted, test conditions: ATT1 + AMP + ATT2 in cascade.

Information furnished by Analog Devices is believed to be accurate and reliable. However, no responsibility is assumed by Analog Devices for its use, nor for any infringements of patents or other rights of third parties that may result from its use. Specifications subject to change without notice. No license is granted by implication or otherwise under any patent or patent rights of Analog Devices. Trademarks and registered trademarks are the property of their respective owners.

For price, delivery, and to place orders: Analog Devices, Inc., One Technology Way, P.O. Box 9106, Norwood, MA 02062-9106
 Phone: 781-329-4700 • Order online at www.analog.com
 Application Support: Phone: 1-800-ANALOG-D



GaAs MMIC ANALOG VARIABLE GAIN AMPLIFIER, 0.5 - 6.0 GHz

Gain vs. Frequency Over Vctl [1]

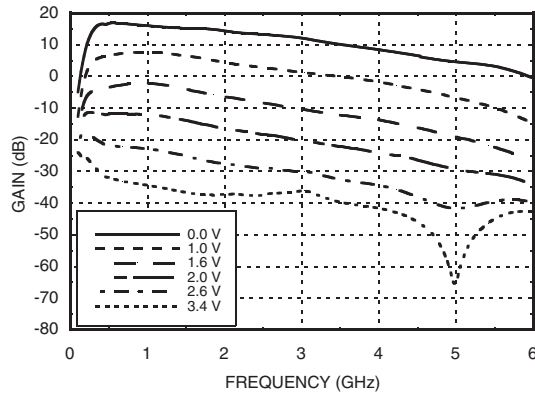

Gain Over Temperature (Vctl = 0V) [1]

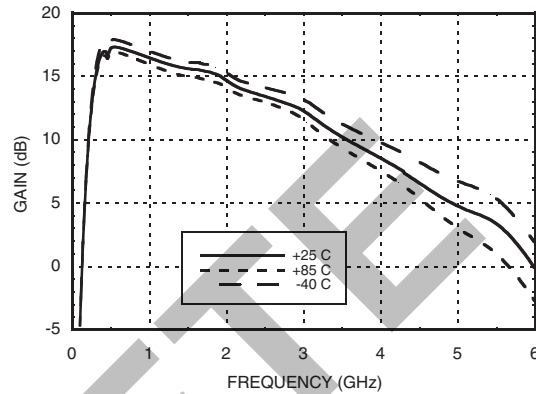

Gain vs. Vctl Over Temperature @ 0.5 GHz [1]

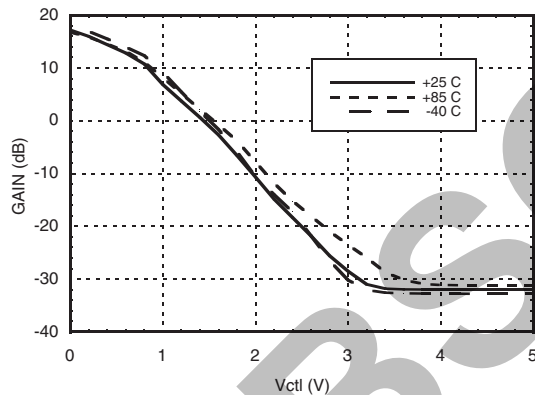

Gain vs. Vctl Over Temperature @ 2 GHz [1]

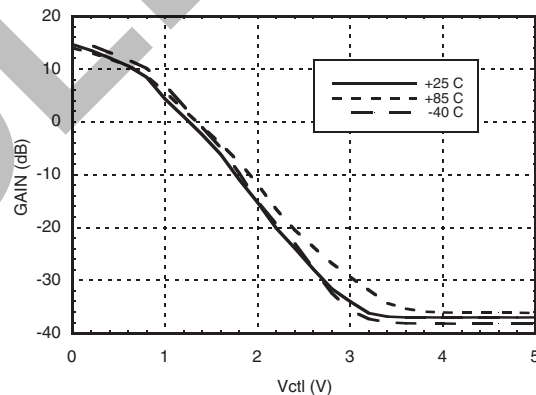

Gain vs. Vctl Over Temperature @ 4 GHz [1]

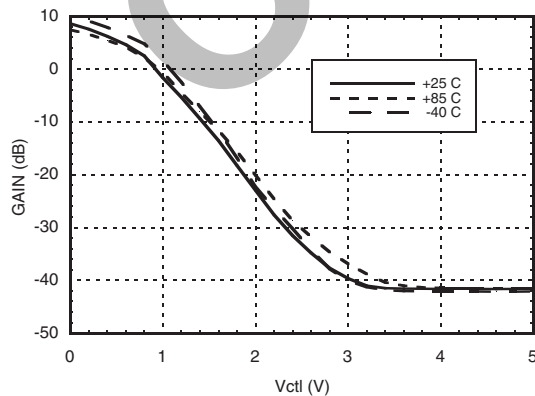

Gain vs. Vctl Over Temperature @ 6 GHz [1]

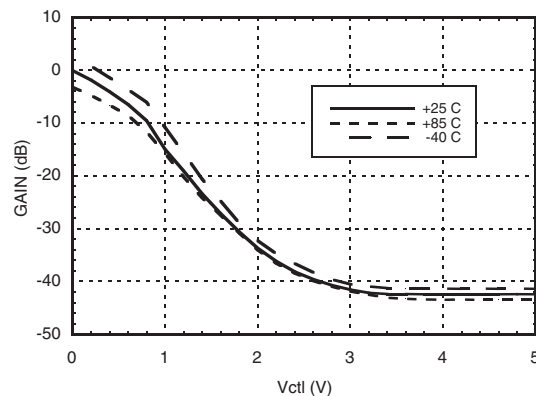

[1] ATT1 + AMP + ATT2

Information furnished by Analog Devices is believed to be accurate and reliable. However, no responsibility is assumed by Analog Devices for its use, nor for any infringements of patents or other rights of third parties that may result from its use. Specifications subject to change without notice. No license is granted by implication or otherwise under any patent or patent rights of Analog Devices. Trademarks and registered trademarks are the property of their respective owners.

For price, delivery, and to place orders: Analog Devices, Inc., One Technology Way, P.O. Box 9106, Norwood, MA 02062-9106 Phone: 781-329-4700 • Order online at www.analog.com Application Support: Phone: 1-800-ANALOG-D



GaAs MMIC ANALOG VARIABLE GAIN AMPLIFIER, 0.5 - 6.0 GHz

Input Return Loss Over Vctl [1]

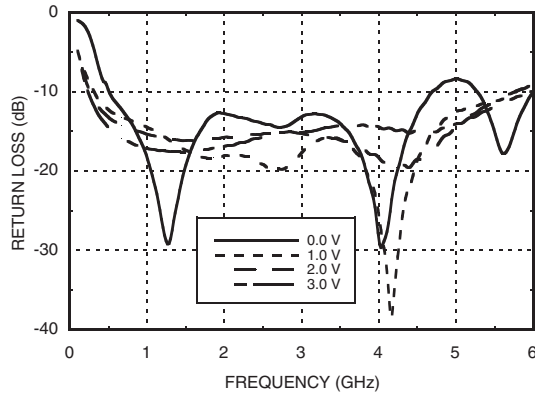

Input Return Loss Over Temperature (Vctl = 0V) [1]

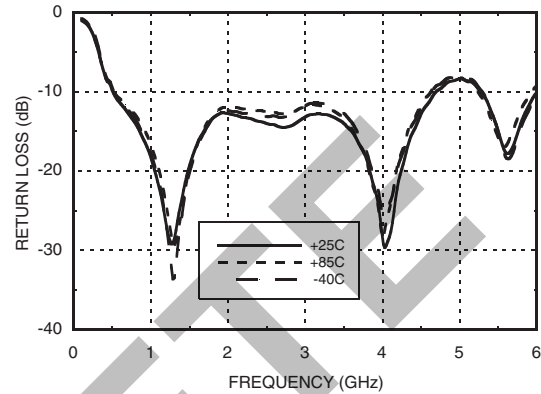

Output Return Loss Over Vctl [1]

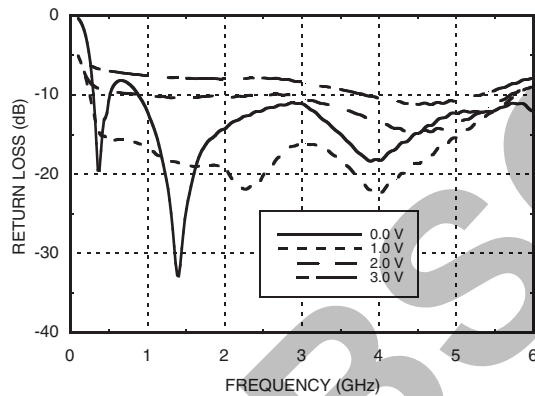

Output Return Loss Over Temperature (Vctl = 0V) [1]

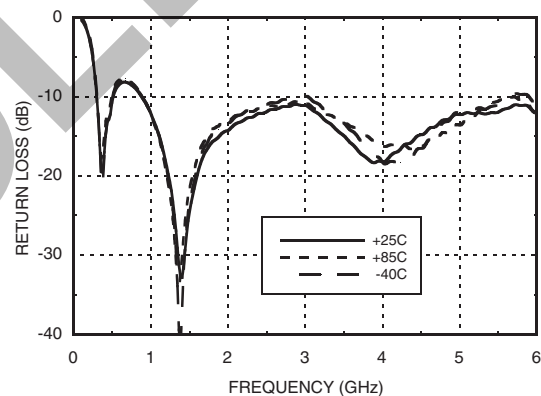

Output IP3 vs. Vctl [1]

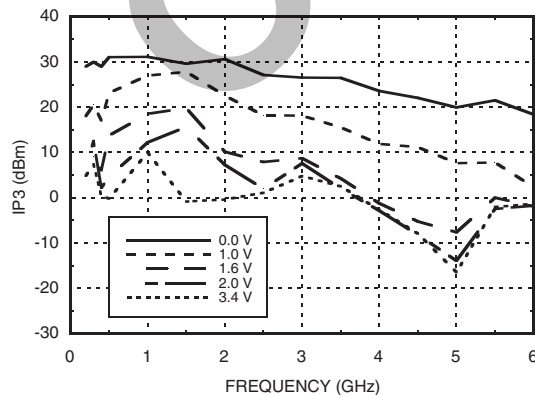

Output IP3 vs. Temperature (Vctl = 0V) [1]

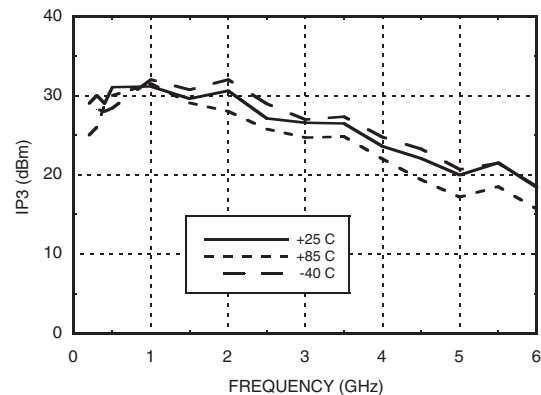

[1] ATT1 + AMP + ATT2

Information furnished by Analog Devices is believed to be accurate and reliable. However, no responsibility is assumed by Analog Devices for its use, nor for any infringements of patents or other rights of third parties that may result from its use. Specifications subject to change without notice. No license is granted by implication or otherwise under any patent or patent rights of Analog Devices. Trademarks and registered trademarks are the property of their respective owners.

For price, delivery, and to place orders: Analog Devices, Inc., One Technology Way, P.O. Box 9106, Norwood, MA 02062-9106 Phone: 781-329-4700 • Order online at www.analog.com Application Support: Phone: 1-800-ANALOG-D



**GaAs MMIC ANALOG VARIABLE
GAIN AMPLIFIER, 0.5 - 6.0 GHz**

Output IP2 vs. Vctl [1]

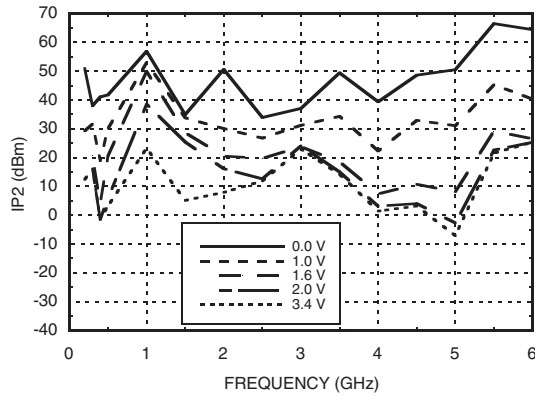

Output IP2 vs. Temperature (Vctl = 0V) [1]

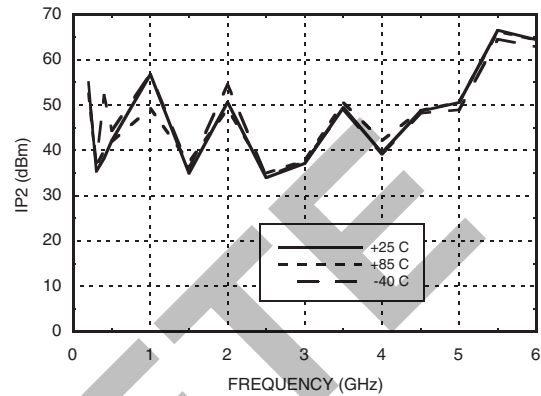

**Noise Figure Over Temperature
(Vctl = 0V) [1]**

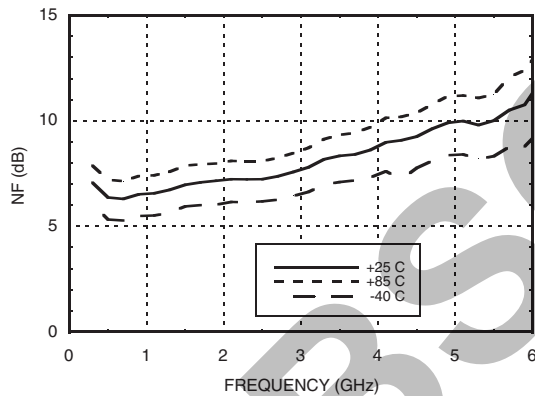

**Output P1dB Over Temperature
(Vctl = 0V) [1]**

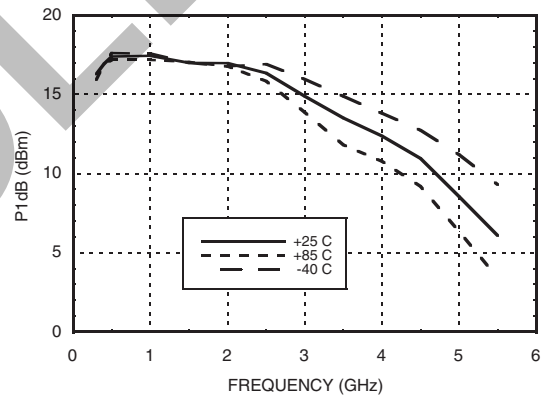

[1] ATT1 + AMP + ATT2

Information furnished by Analog Devices is believed to be accurate and reliable. However, no responsibility is assumed by Analog Devices for its use, nor for any infringements of patents or other rights of third parties that may result from its use. Specifications subject to change without notice. No license is granted by implication or otherwise under any patent or patent rights of Analog Devices. Trademarks and registered trademarks are the property of their respective owners.

For price, delivery, and to place orders: Analog Devices, Inc., One Technology Way, P.O. Box 9106, Norwood, MA 02062-9106 Phone: 781-329-4700 • Order online at www.analog.com Application Support: Phone: 1-800-ANALOG-D



GaAs MMIC ANALOG VARIABLE GAIN AMPLIFIER, 0.5 - 6.0 GHz

Insertion Loss vs. Vctl [2]

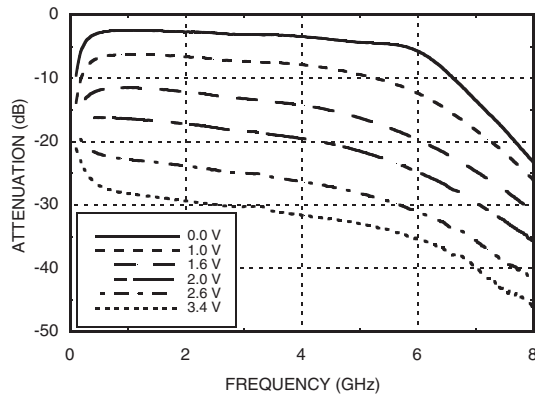

Insertion Loss vs. Temperature [2]

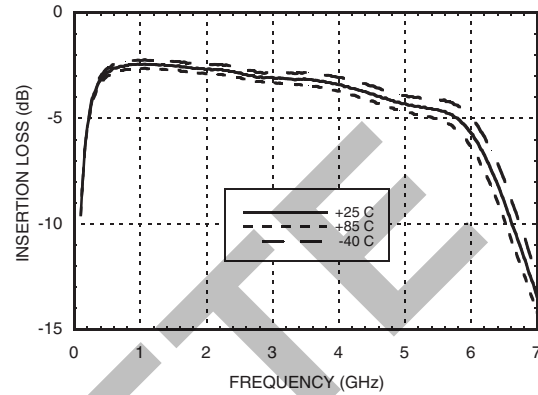

Input Return Loss vs. Vctl [2]

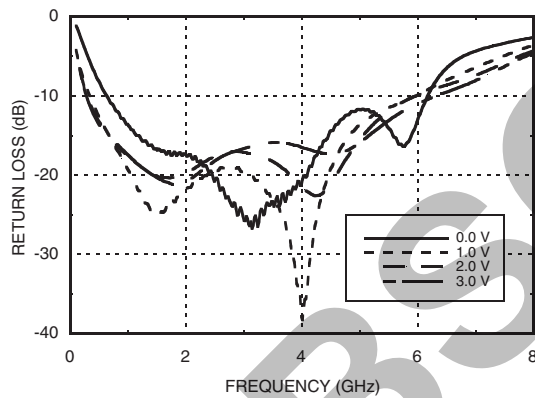

Output Return Loss vs. Vctl [2]

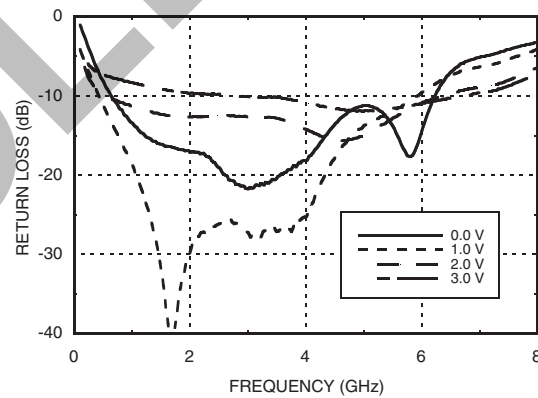

Input IP3 vs. Vctl [2]

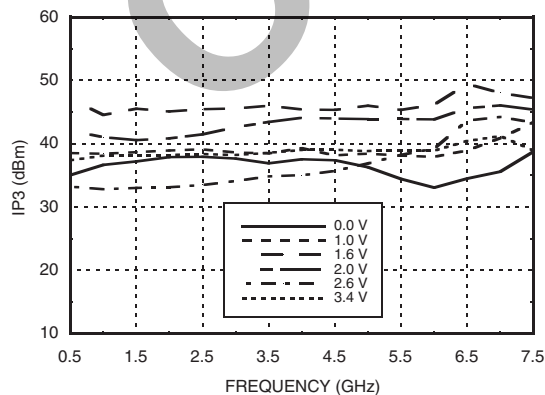

Input IP3 vs. Temperature (Vctl = 0V) [2]

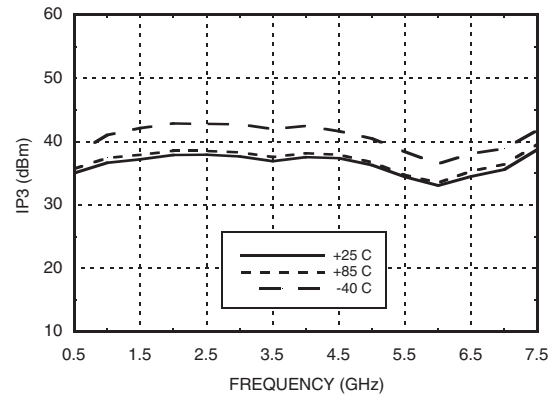

[2] ATT1 Only

Information furnished by Analog Devices is believed to be accurate and reliable. However, no responsibility is assumed by Analog Devices for its use, nor for any infringements of patents or other rights of third parties that may result from its use. Specifications subject to change without notice. No license is granted by implication or otherwise under any patent or patent rights of Analog Devices. Trademarks and registered trademarks are the property of their respective owners.

For price, delivery, and to place orders: Analog Devices, Inc., One Technology Way, P.O. Box 9106, Norwood, MA 02062-9106 Phone: 781-329-4700 • Order online at www.analog.com Application Support: Phone: 1-800-ANALOG-D



GaAs MMIC ANALOG VARIABLE GAIN AMPLIFIER, 0.5 - 6.0 GHz

Absolute Maximum Ratings

| | |
|--|----------------|
| RF Input Power | +12 dBm |
| Supply Voltage | 5.5 Vdc |
| Channel Temperature | 150 °C |
| Continuous P _{diss} (T = 85 °C) (derate 8.5 mW/°C above 85 °C) [1] | 0.55 W |
| Thermal Resistance (Junction to Exposed Ground Paddle) | 120 °C/W |
| Storage Temperature | -65 to +150 °C |
| Operating Temperature | -40 to +85 °C |
| ESD Sensitivity (HBM) | Class 1A |

Bias Voltage

| V _{dd} (V) | I _{dd} (Typ.) (mA) |
|---------------------|-----------------------------|
| +5V | 90 |



ELECTROSTATIC SENSITIVE DEVICE
OBSERVE HANDLING PRECAUTIONS

Outline Drawing

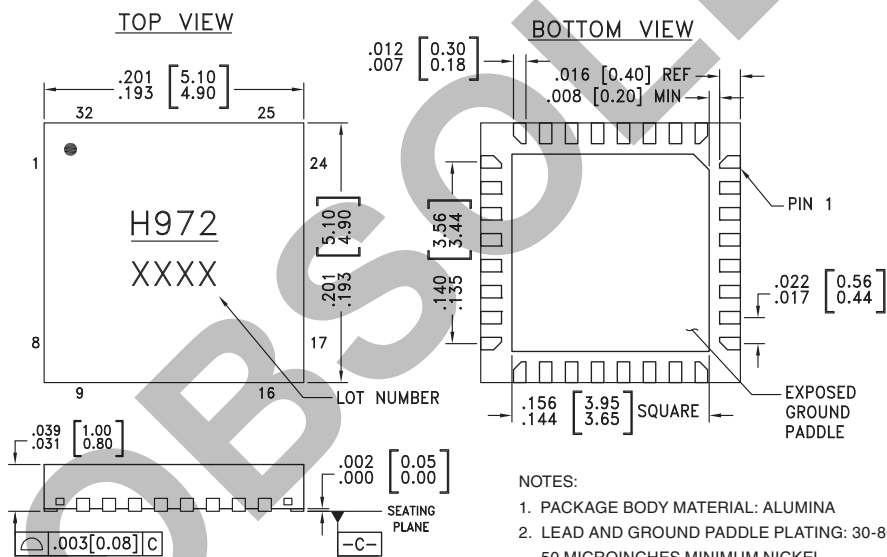

NOTES:

- PACKAGE BODY MATERIAL: ALUMINA
- LEAD AND GROUND PADDLE PLATING: 30-80 MICROINCHES GOLD OVER 50 MICROINCHES MINIMUM NICKEL.
- DIMENSIONS ARE IN INCHES [MILLIMETERS].
- LEAD SPACING TOLERANCE IS NON-CUMULATIVE
- PACKAGE WARP SHALL NOT EXCEED 0.05mm DATUM [-C-]
- ALL GROUND LEADS AND GROUND PADDLE MUST BE SOLDERED TO PCB RF GROUND.
- CLASSIFIED AS MOISTURE SENSITIVITY LEVEL (MSL) 1.

Package Information

| Part Number | Package Body Material | Lead Finish | MSL Rating | Package Marking [1] |
|-------------|--|---------------|------------|---------------------|
| HMC972LP5E | RoHS-compliant Low Stress Injection Molded Plastic | 100% matte Sn | MSL1 [2] | H972 XXXX |



[1] 4-Digit lot number XXXX

[2] Max peak reflow temperature of 260 °C

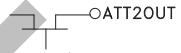
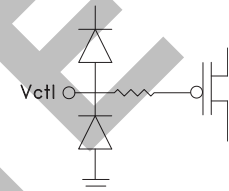
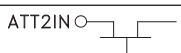
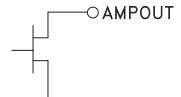

GaAs MMIC ANALOG VARIABLE GAIN AMPLIFIER, 0.5 - 6.0 GHz

Pin Descriptions

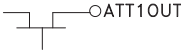
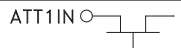
| Pin Number | Function | Description | Interface Schematic |
|---|----------|--|---|
| 1 - 11, 14, 17 - 20, 22, 23, 25, 27, 29, 30 | N/C | No connection required. The pins are not connected internally; however, all data shown herein was measured with these pins connected to RF/DC ground externally. | |
| 12 | ATT2OUT | This port is matched to 50 Ohms. Blocking capacitor required. |  |
| 13 | Vctl | Attenuation control voltage for the attenuators. 0V for minimum attenuation, 5V for maximum attenuation. |  |
| 15 | ATT2VDD | Power Supply for attenuator 2. External bypass capacitor is required. See application circuit. | |
| 16 | ATT2IN | This port is matched to 50 Ohms. Blocking capacitor required. Attenuator performance is similar to HMC973LP3E. |  |
| 21 | AMPOUT | This port is matched to 50 Ohms. External Choke inductor and DC blocking capacitor are required. See application circuit. |  |
| 24 | GND | This pin and the exposed ground paddle must be connected to RF/DC ground. |  |
| 26 | AMPIN | This port is matched to 50 Ohms. Blocking capacitor required. Amplifier performance is similar to HMC589ST89E. |  |
| 28 | ATT1OUT | This port is matched to 50 Ohms. Blocking capacitor required. |  |
| 31 | ATT1VDD | Power supply for attenuator 1. External bias capacitor is required. See application circuit. | |
| 32 | ATT1IN | This port is matched to 50 Ohms. Blocking capacitor required. Attenuator performance is similar to HMC973LP3E. |  |

13

VARIABLE GAIN AMPLIFIERS - ANALOG - SMT



GaAs MMIC ANALOG VARIABLE GAIN AMPLIFIER, 0.5 - 6.0 GHz

Application Circuit

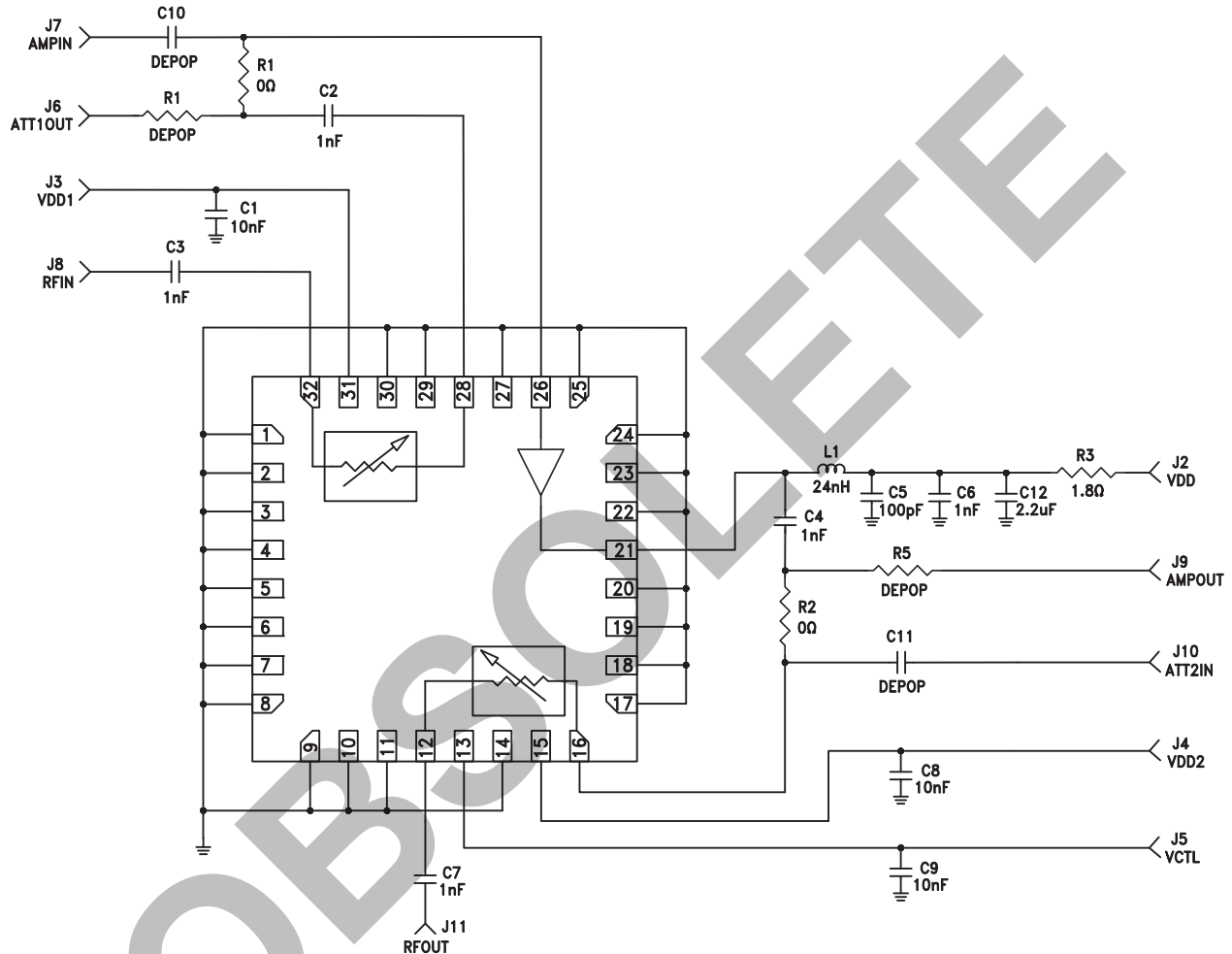

13

VARIABLE GAIN AMPLIFIERS - ANALOG - SMT

Information furnished by Analog Devices is believed to be accurate and reliable. However, no responsibility is assumed by Analog Devices for its use, nor for any infringements of patents or other rights of third parties that may result from its use. Specifications subject to change without notice. No license is granted by implication or otherwise under any patent or patent rights of Analog Devices. Trademarks and registered trademarks are the property of their respective owners.

For price, delivery, and to place orders: Analog Devices, Inc., One Technology Way, P.O. Box 9106, Norwood, MA 02062-9106 Phone: 781-329-4700 • Order online at www.analog.com Application Support: Phone: 1-800-ANALOG-D



GaAs MMIC ANALOG VARIABLE GAIN AMPLIFIER, 0.5 - 6.0 GHz

Evaluation PCB

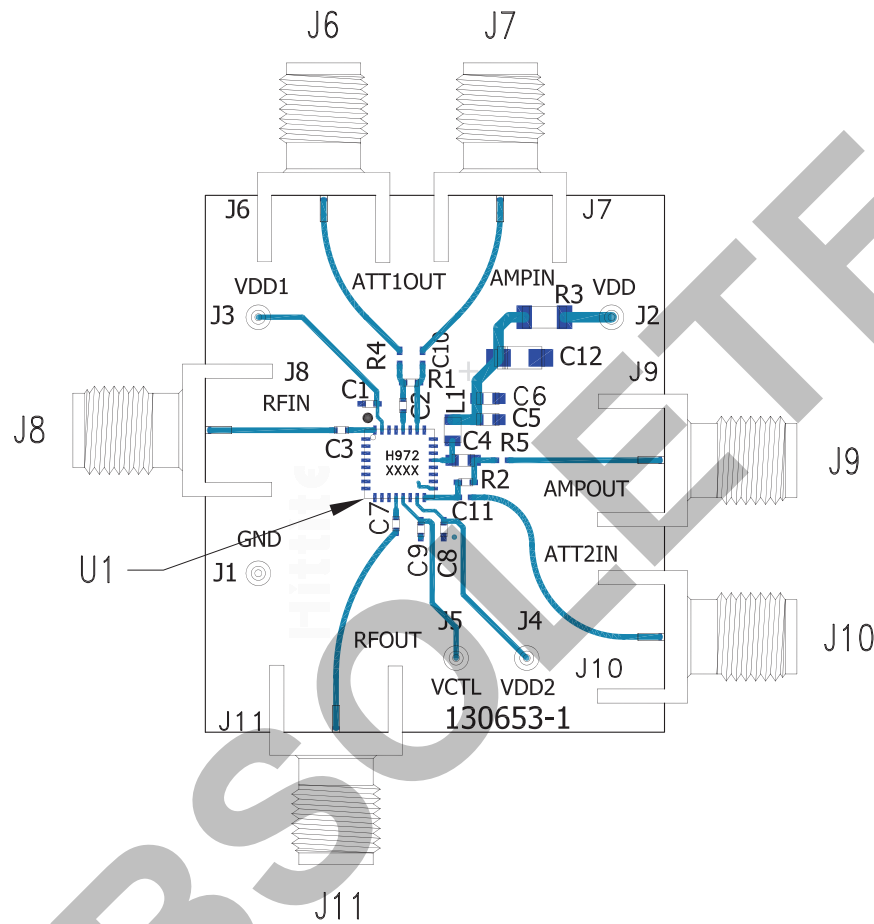

List of Materials for Evaluation PCB 130656 [1]

| Item | Description |
|------------|------------------------------------|
| J1 - J5 | DC Connector Header |
| J6 - J11 | PCB Mount SMA RF Connector |
| C1, C8, C9 | 10 nF Capacitor, 0402 Pkg |
| C2, C3, C7 | 1000 pF Capacitor, 0402 Pkg. |
| C4, C6 | 1000 pF Capacitor, 0603 Pkg. |
| C5 | 100 pF Capacitor, 0603 Pkg. |
| C12 | 2.2 μF Capacitor, CASE A Pkg. |
| L1 | 24 nH Inductor 0603 Pkg. |
| R1, R2 | 0 Ohm Resistor, 0402 Pkg. |
| R3 | 1.8 Ohm Resistor, 1206 Pkg. |
| U1 | HMC972LP5E Variable Gain Amplifier |
| PCB [2] | 130653 Evaluation PCB |

[1] Reference this number when ordering complete evaluation PCB

[2] Circuit Board Material: Rogers 4350

The circuit board used in the application should use RF circuit design techniques. Signal lines should have 50 Ohm impedance while the package ground leads and exposed paddle should be connected directly to the ground plane similar to that shown. A sufficient number of via holes should be used to connect the top and bottom ground planes. The evaluation circuit board shown is available from Hittite upon request.

Information furnished by Analog Devices is believed to be accurate and reliable. However, no responsibility is assumed by Analog Devices for its use, nor for any infringements of patents or other rights of third parties that may result from its use. Specifications subject to change without notice. No license is granted by implication or otherwise under any patent or patent rights of Analog Devices. Trademarks and registered trademarks are the property of their respective owners.

For price, delivery, and to place orders: Analog Devices, Inc., One Technology Way, P.O. Box 9106, Norwood, MA 02062-9106 Phone: 781-329-4700 • Order online at www.analog.com Application Support: Phone: 1-800-ANALOG-D

**GaAs MMIC ANALOG VARIABLE
GAIN AMPLIFIER, 0.5 - 6.0 GHz****Notes:**

OBSOLETE

13

VARIABLE GAIN AMPLIFIERS - ANALOG - SMT