



Multilayer Antenna

For 5150-5950MHz

ANT165550ST-1003A1

1.6x0.8mm [EIA 0603]*

* Dimensions Code JIS[EIA]

Multilayer Antenna

Conformity to RoHS Directive

For 5150-5950MHz

ANT165550ST-1003A1

SHAPES AND DIMENSIONS

[Top view]

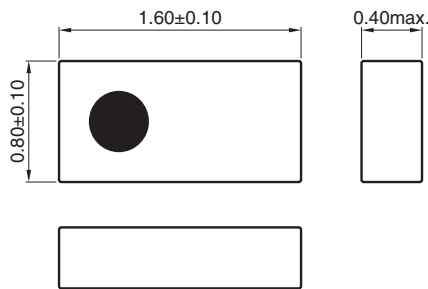

[Bottom view]

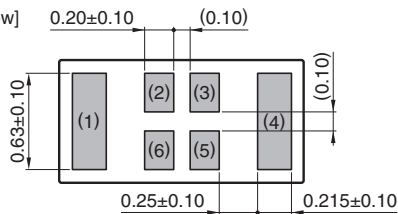

Dimensions in mm

Terminal functions

| | |
|---|--------------------|
| 1 | Dummy pad |
| 2 | Feed point |
| 3 | Feed point |
| 4 | Radiator electrode |
| 5 | Feed point |
| 6 | Feed point |

*Terminal (2),(3),(5) and (6) :Connected in inner structure

RECOMMENDED LAND PATTERN

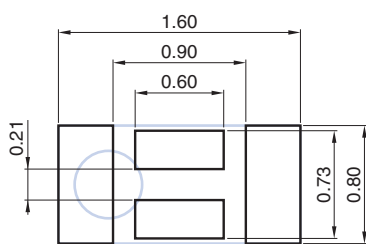

Dimensions in mm

SOLDER RESIST PATTERN

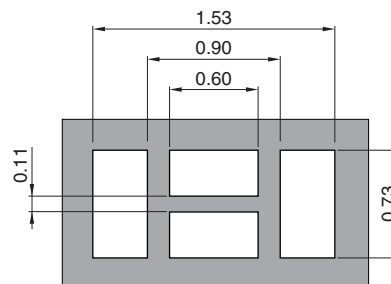

Dimensions in mm

○ RoHS Directive Compliant Product: See the following for more details. <https://product.tdk.com/info/en/environment/rohs/index.html>

- All specifications are subject to change without notice.
- Before using these products, be sure to request the delivery specifications.

ANT165550ST-1003A1

EVALUATION BOARD

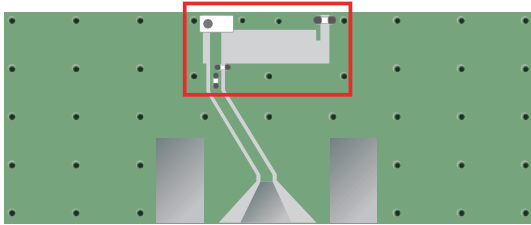

PCB size : 25mm x 10mm x 1mm
Antenna area : 6 x 2.5 mm

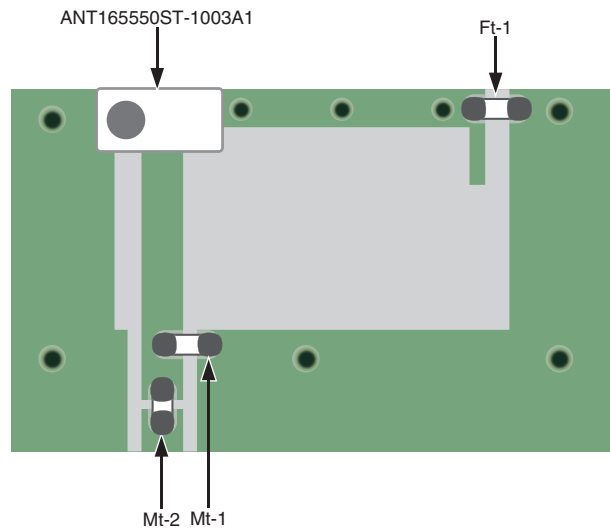

| | Element Value |
|------|---------------|
| Ft-1 | 0.9pF |
| Mt-1 | 0.1pF |
| Mt-2 | 0.5pF |

Measurement condition for Radiation Pattern

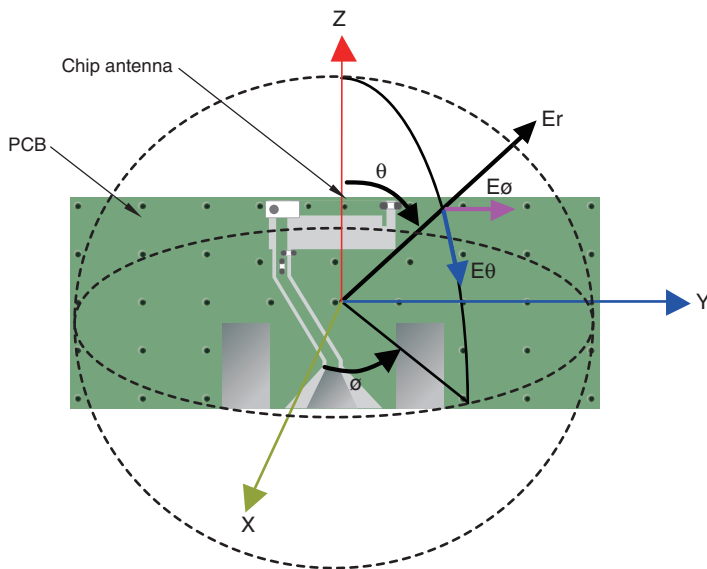

- All specifications are subject to change without notice.
- Before using these products, be sure to request the delivery specifications.

ANT165550ST-1003A1

ELECTRICAL CHARACTERISTICS

| Item | Frequency Range (MHz) | Min. | Typ. | Max. |
|---------------------------------------|-----------------------|------|--------------|------|
| VSWR | 5150 to 5950 | — | 1.60 | 3.0 |
| Antenna Gain (dBi)** | 5150 to 5950 | — | 2.6 | — |
| Polarization | | | Linear | |
| PCB size (mm) | | | 25×10 | |
| Antenna keep-out area (mm) | | | 6×2.5 | |
| Characteristic Impedance (Ω) | | | 50 (Nominal) | |

· This is typical antenna performance with the standard PCB.

** Reference value

TEMPERATURE RANGE

| Operating temperature (°C) | Storage temperature (°C) |
|----------------------------|--------------------------|
| -40 to +85 | -40 to +85 |

FREQUENCY CHARACTERISTICS

EFFICIENCY AND VSWR

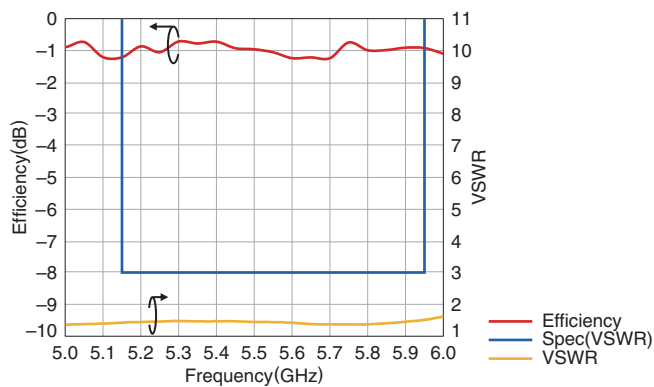

• Tested antenna has been soldered. Evaluation board size is 25x10x1 mm.

ANT165550ST-1003A1

RADIATION PATTERNS

5GHz BAND

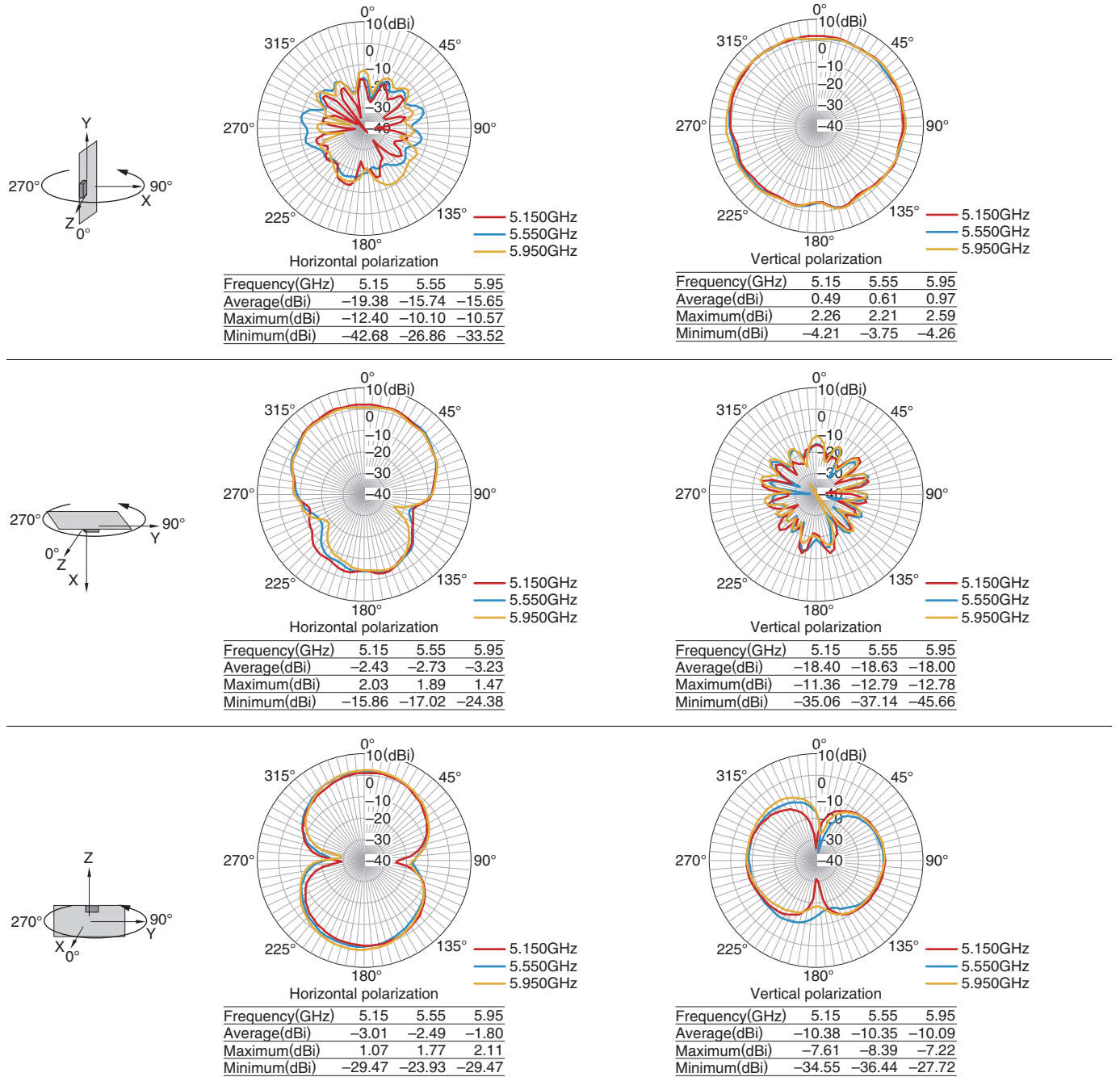

• Tested antenna has been soldered. Evaluation board size is 25x10x1 mm.

- All specifications are subject to change without notice.
- Before using these products, be sure to request the delivery specifications.

ANT165550ST-1003A1

RADIATION PATTERNS (TOTAL POWER)

5GHz BAND

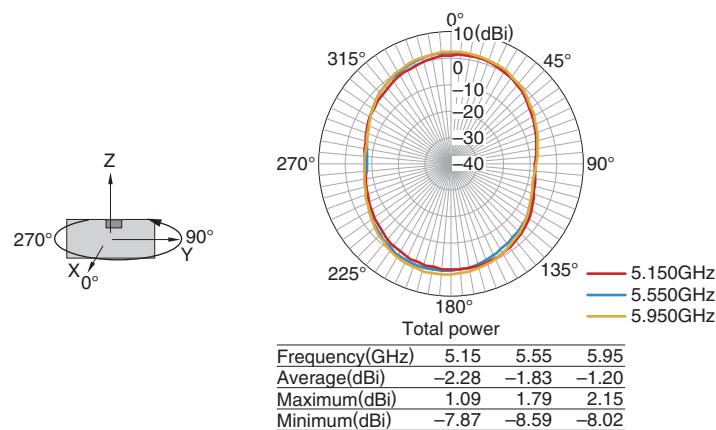
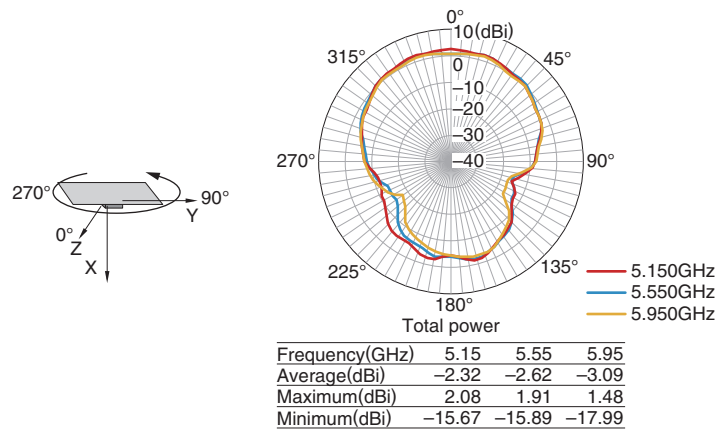
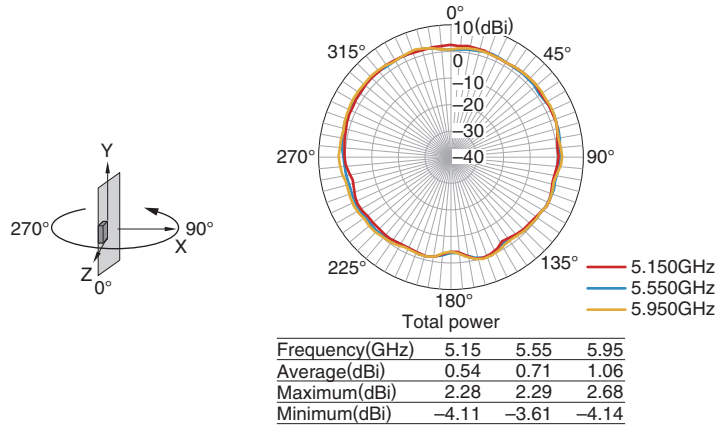

• Tested antenna has been soldered. Evaluation board size is 25x10x1 mm.

- All specifications are subject to change without notice.
- Before using these products, be sure to request the delivery specifications.

ANT165550ST-1003A1

PACKAGING STYLE

REEL DIMENSIONS

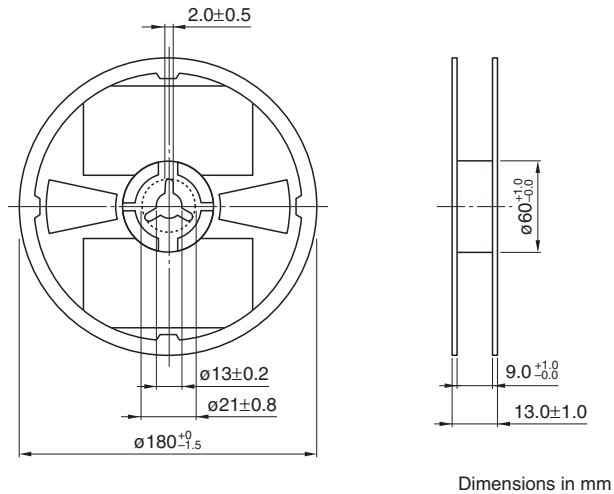

Dimensions in mm

TAPE DIMENSIONS

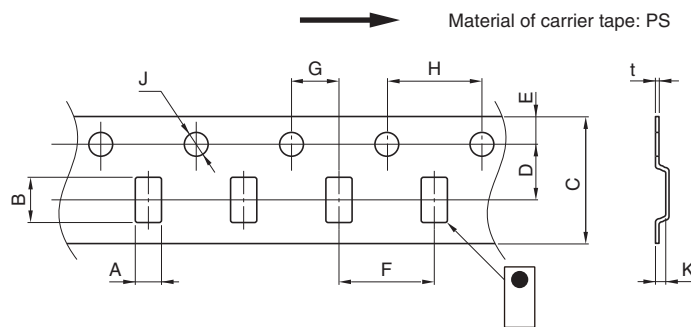

Dimensions in mm

| A | B | C | D | E | F | G | H | J | K | t |
|-----------|----------|---------|----------|----------|---------|----------|---------|------------|----------|-----------|
| 0.97±0.05 | 1.8±0.05 | 8.0±0.2 | 3.5±0.05 | 1.75±0.1 | 4.0±0.1 | 2.0±0.05 | 4.0±0.1 | 1.5+0.1/-0 | 0.55max. | 0.25±0.05 |

PACKAGE QUANTITY

Standard package quantity
(pieces/reel)

4,000

- All specifications are subject to change without notice.
- Before using these products, be sure to request the delivery specifications.

ANT165550ST-1003A1

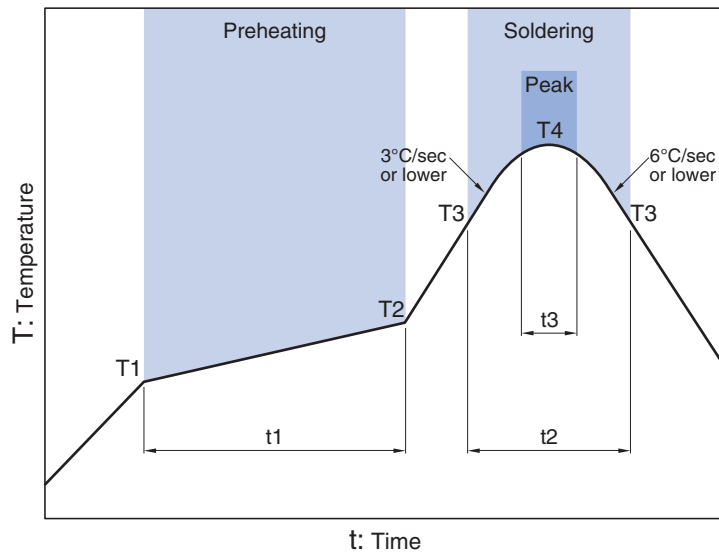
RECOMMENDED REFLOW PROFILE

| Preheating | | | Soldering | | | |
|------------|-------|--------------|--------------------------|--------------|--------------|------------|
| | | | Critical zone (T3 to T4) | | Peak | |
| Temp. | Temp. | Time | Temp. | Time | Temp. | Time |
| T1 | T2 | t1 | T3 | t2 | T4 | t3* |
| 150°C | 200°C | 60 to 120sec | 217°C | 60 to 120sec | 240 to 260°C | 30sec max. |

* t3 : Time within 5°C of actual peak temperature
 The maximum number of reflow is 3.

- All specifications are subject to change without notice.
- Before using these products, be sure to request the delivery specifications.

REMINDERS FOR USING THESE PRODUCTS

Before using these products, be sure to request the delivery specifications.

SAFETY REMINDERS

Please pay sufficient attention to the warnings for safe designing when using these products.

REMINDERS

The products listed on this catalog are intended for use in general electronic equipment (AV equipment, telecommunications equipment, home appliances, amusement equipment, computer equipment, personal equipment, office equipment, measurement equipment, industrial robots) under a normal operation and use condition.

The products are not designed or warranted to meet the requirements of the applications listed below, whose performance and/or quality require a more stringent level of safety or reliability, or whose failure, malfunction or trouble could cause serious damage to society, person or property.

Please understand that we are not responsible for any damage or liability caused by use of the products in any of the applications below or for any other use exceeding the range or conditions set forth in this catalog.

- | | |
|---|--|
| (1) Aerospace/Aviation equipment | (8) Public information-processing equipment |
| (2) Transportation equipment (cars, electric trains, ships, etc.) | (9) Military equipment |
| (3) Medical equipment | (10) Electric heating apparatus, burning equipment |
| (4) Power-generation control equipment | (11) Disaster prevention/crime prevention equipment |
| (5) Atomic energy-related equipment | (12) Safety equipment |
| (6) Seabed equipment | (13) Other applications that are not considered general-purpose applications |
| (7) Transportation control equipment | |

When using this product in general-purpose applications, you are kindly requested to take into consideration securing protection circuit/equipment or providing backup circuits, etc., to ensure higher safety.

- All specifications are subject to change without notice.
- Before using these products, be sure to request the delivery specifications.