

Accu-P[®] MP Medical Grade



General Specifications



GENERAL DESCRIPTION

AVX has a wide range of thin-film chip capacitors that feature highly repeatable performance, extremely accurate capacitance, and very high Q factor. These features have now been applied to the new Accu-P[®] MP series, which can provide all of these benefits in a thin-film chip capacitor for medical and healthcare RF signal and power applications. These capacitors provide ultra-tight capacitive tolerance, low ESR at very high frequency, and high stability with respect to temperature, time, frequency, and voltage variation. The Accu-P[®] MP is available in both Sn/Pb and RoHS compliant termination styles.

APPLICATIONS

- Embedded medical systems
- Medical systems featuring RF Signals
- Medical power applications which require extremely high accuracy

PRODUCT ADVANTAGES

- Extremely tight capacitive tolerance
- Low ESR and high Q at very high frequencies
- Improved RF power handling capability
- Sn/Pb and RoHS compliant termination styles available.

HOW TO ORDER

MP01 ↓	Z ↓	J ↓	100 ↓	A ↓	B ↓	W ↓	G ↓
Size	Rated Voltage	Dielectric Code	Capacitance	Tolerance for C≤2.0pF*	Accu-P Technology Type	Termination Finish	Medical Grade
MP01 = 0201 MP02 = 0402 MP03 = 0603	Z = 10V Y = 16V 3 = 25V 5 = 50V 1 = 100V	J = 0±30ppm/°C K = 0±60ppm/°C	Capacitance expressed in pF. (2 significant digits + number of zeros) for values <10pF , letter R denotes decimal point. Example: 68pF = 680 8.2pF = 8R2	Z = ±0.01pF P = ±0.02pF Q = ±0.03pF A = ±0.05pF B = ±0.1pF C = ±0.25pF	for C≤3.0pF Q = ±0.03pF A = ±0.05pF B = ±0.1pF C = ±0.25pF	W = Sn90Pb10 S = Sn100	
For 01005 case size, contact factory		See <i>Capacitance Voltage Range Chart for available Temperature Coefficients</i>	<i>For Capacitance values which require more than 2 significant figures, contact factory.</i>	for C≤5.6pF A = ±0.05pF B = ±0.1pF C = ±0.25pF			
				for 5.6pF<C<10pF B = ±0.1pF C = ±0.25pF D = ±0.5pF			
				for C≥10pF F = ±1% G = ±2% J = ±5%			



LEAD-FREE
LEAD-FREE COMPATIBLE COMPONENT



For RoHS compliant products, please select correct termination style.

General Specifications

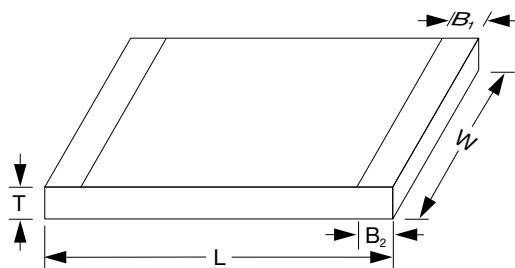

ACCU-P[®] MP (Medical Thin-Film Chip Capacitors)

	0201 (MP01)*	0402 (MP02)*	0603 (MP03)*
L	0.05 (0.023±0.002)	1.00±0.10 (0.039±0.004)	1.60±0.10 (0.063±0.004)
W	0.325±0.050 (0.0128±0.002)	0.55±0.07 (0.022±0.003)	0.81±0.10 (0.032±0.004)
T	0.225±0.050 (0.009±0.002)	0.40±0.10 (0.016±0.004)	0.63±0.10 (0.025±0.004)
B ₁	0.10±0.10 (0.004±0.004)	0.00 ^{+0.1} _{-0.0} (0.000 ^{+0.004} _{-0.000})	0.35±0.15 (0.014±0.006)
B ₂	0.15±0.05 (0.006±0.002)	0.20±0.10 (0.008±0.004)	0.35±0.15 (0.014±0.006)

*Mount Black Side Up

DIMENSIONS: millimeters (inches)

ELECTRICAL SPECIFICATIONS

Operating and Storage Temperature Range	-55°C to +125°C
Temperature Coefficients ⁽¹⁾	0 ± 30ppm/°C dielectric code "J" / 0 ± 60ppm/°C dielectric code "K"
Capacitance Measurement	1 MHz ±100 kHz; 1.0 Volt ±0.2Vrms
Insulation Resistance (IR)	≥10 ¹¹ Ohms (≥10 ¹⁰ Ohms for 0201 and 0402 size)
Q Factor	Not less than 1000 for Capacitance values > 0.5 pF Not less than 500 for Capacitance values ≤ 0.5 pF
Proof Voltage	8 x U _R for 5 secs.
Aging Characteristic	Zero
Dielectric Absorption	0.01%

Signal and Power Type Capacitors

Accu-P® Capacitance Ranges (pF)

TEMP. COEFFICIENT CODE

“J” = 0±30ppm/°C (-55°C to +125°C)⁽²⁾ “K” = 0±60ppm/°C (-55°C to +125°C)⁽²⁾

Size		0201				0402				0603				
Voltage		10	16	25	50	10	16	25	50	10	16	25	50	100
Cap in pF ⁽¹⁾	Cap code													
0.05	— R05													
0.1	— 0R1													
0.2	— 0R2													
0.3	— 0R3													
0.4	— 0R4													
0.5	— 0R5													
0.6	— 0R6													
0.7	— 0R7													
0.8	— 0R8													
0.9	— 0R9													
1.0	— 1R0													
1.1	— 1R1													
1.2	— 1R2													
1.3	— 1R3													
1.4	— 1R4													
1.5	— 1R5													
1.6	— 1R6													
1.7	— 1R7													
1.8	— 1R8													
1.9	— 1R9													
2.0	— 2R0													
2.1	— 2R1													
2.2	— 2R2													
2.3	— 2R3													
2.4	— 2R4													
2.5	— 2R5													
2.6	— 2R6													
2.7	— 2R7													
2.8	— 2R8													
2.9	— 2R9													
3.0	— 3R0													
3.1	— 3R1													
3.2	— 3R2													
3.3	— 3R3													
3.4	— 3R4													
3.5	— 3R5													
3.6	— 3R6													
3.7	— 3R7													
3.8	— 3R8													
3.9	— 3R9													
4.0	— 4R0													
4.1	— 4R1													
4.2	— 4R2													
4.3	— 4R3													
4.4	— 4R4													
4.5	— 4R5													
4.6	— 4R6													
4.7	— 4R7													
5.1	— 5R1													
5.6	— 5R6													
6.2	— 6R2													
6.8	— 6R8													
7.5	— 7R5													
8.2	— 8R2													
9.1	— 9R1													
10.0	— 100													
11.0	— 110													
12.0	— 120													
13.0	— 130													
14.0	— 140													
15.0	— 150													
16.0	— 160													
17.0	— 170													
18.0	— 180													
19.0	— 190													
20.0	— 200													
21.0	— 210													
22.0	— 220													
24.0	— 240													
27.0	— 270													
30.0	— 300													
33.0	— 330													
39.0	— 390													
47.0	— 470													
56.0	— 560													
68.0	— 680													

Temperature Coefficients: J = 0±30ppm/°C (-55°C to +125°C)⁽²⁾; K = 0±60ppm/°C (-55°C to +125°C)⁽²⁾

⁽¹⁾ For capacitance values higher than listed in table, please consult factory.

⁽²⁾ TC shown is per EIA/IEC Specifications.

These values are produced with “K” temperature coefficient code only.

0201 Typical Electrical Tables

Part Number	Capacitance (pF)	ESR Max. mOhm	SRF GHz	Q Standard Value @ 1GHz		Frequency 900MHz			Frequency 1900MHz			Frequency 2400MHz		
				Typ.	Min.	Ceff (pF)	Q Typ.	ESR Typ. (mOhm)	Ceff (pF)	Q Typ.	ESR Typ. (mOhm)	Ceff (pF)	Q Typ.	ESR Typ. (mOhm)
U_R = 10V (Voltage code Z)														
MP01Z#R05-B--	0.05	N/A	20.9	599	402	0.055	650	3220	0.056	265	4010	0.057	195	4450
MP01Z#R01-B--	0.1	6000	19.4	574	316	0.110	614	3682	0.112	246	3036	0.113	188	3113
MP01Z#R15-B--	0.15	4800	17.9	510	280	0.163	550	2087	0.166	220	2404	0.168	170	2441
MP01Z#R2-B--	0.2	3600	16.4	445	245	0.216	520	1693	0.220	210	1971	0.223	160	1970
MP01Z#R25-B--	0.25	2700	15.5	436	240	0.262	510	1371	0.268	204	1604	0.272	153	1646
MP01Z#R3-B--	0.3	1800	14.6	427	235	0.309	500	1149	0.316	199	1337	0.320	146	1421
MP01Z#R35-B--	0.35	1650	14.1	423	232	0.360	494	1001	0.369	196	1177	0.374	144	1265
MP01Z#R4-B--	0.4	1500	12.5	418	230	0.411	489	874	0.421	193	1038	0.427	142	1129
MP01Z#R45-B--	0.45	1400	11.9	413	227	0.461	484	819	0.473	191	972	0.481	140	1066
MP01Z#R5-B--	0.5	1300	11.3	408	224	0.512	478	765	0.526	188	906	0.535	138	1003
MP01Z#R55-B--	0.55	1200	10.9	403	222	0.563	473	710	0.578	186	840	0.588	137	940
MP01Z#R6-B--	0.6	1100	10.4	398	219	0.614	468	663	0.631	183	791	0.642	135	882
MP01Z#R65-B--	0.65	1025	10.0	394	217	0.664	462	624	0.683	181	742	0.695	133	825
MP01Z#R7-B--	0.7	950	9.5	389	214	0.715	457	580	0.735	178	693	0.749	131	767
MP01Z#R75-B--	0.75	900	9.3	384	211	0.766	452	557	0.788	176	664	0.802	129	729
MP01Z#R8-B--	0.8	850	9.1	379	209	0.817	446	534	0.840	173	635	0.856	127	692
MP01Z#R85-B--	0.85	825	8.9	374	206	0.868	441	511	0.893	171	606	0.909	126	654
MP01Z#R9-B--	0.9	800	8.8	370	203	0.918	436	487	0.945	168	577	0.963	124	616
MP01Z#R95-B--	0.95	775	8.6	365	201	0.969	430	464	0.998	166	548	1.016	122	579
MP01Z#1R0-B--	1	750	8.4	360	198	1.020	425	441	1.050	163	519	1.070	120	541
Contact Factory	1.05	725	8.2	358	197	1.078	421	426	1.112	161	502	1.134	119	523
MP01Z#1R1-B--	1.1	700	8.0	355	195	1.135	418	410	1.173	159	486	1.199	117	505
Contact Factory	1.15	650	7.8	353	194	1.193	414	395	1.235	157	469	1.263	116	488
MP01Z#1R2-B--	1.2	600	7.6	350	193	1.251	411	379	1.296	155	452	1.327	115	470
Contact Factory	1.25	580	7.5	348	191	1.308	407	364	1.358	153	436	1.392	114	452
MP01Z#1R3-B--	1.3	560	7.4	345	190	1.355	403	348	1.419	151	419	1.456	112	434
Contact Factory	1.35	545	7.3	343	189	1.424	400	333	1.481	149	402	1.520	111	416
MP01Z#1R4-B--	1.4	530	7.2	340	187	1.481	396	317	1.542	147	386	1.585	110	398
Contact Factory	1.45	515	7.1	338	186	1.539	393	302	1.604	145	369	1.649	109	381
MP01Z#1R5-B--	1.5	500	7.0	335	184	1.597	389	287	1.665	144	353	1.713	107	363
Contact Factory	1.55	490	6.8	332	183	1.642	386	282	1.714	142	347	1.764	106	358
MP01Z#1R6-B--	1.6	480	6.7	330	181	1.687	382	277	1.762	141	342	1.815	105	352
Contact Factory	1.65	470	6.6	327	180	1.732	378	272	1.810	140	337	1.866	104	347
MP01Z#1R7-B--	1.7	460	6.5	324	178	1.777	375	267	1.859	138	331	1.917	103	342
Contact Factory	1.75	455	6.4	321	176	1.822	371	262	1.907	137	326	1.968	102	337
MP01Z#1R8-B--	1.8	450	6.3	318	175	1.866	367	257	1.955	136	321	2.018	101	331
Contact Factory	1.85	435	6.2	315	173	1.911	364	252	2.003	134	316	2.069	100	326
MP01Z#1R9-B--	1.9	425	6.2	312	172	1.956	360	247	2.052	133	310	2.12	99	321
Contact Factory	1.95	412	6.1	309	170	2.001	357	242	2.100	132	305	2.171	98	316
MP01Z#2R0-B--	2	400	6.0	306	168	2.046	353	237	2.148	131	300	2.222	97	310
MP01Z#2R1-B--	2.1	380	5.9	301	166	2.150	348	232	2.263	128	293	2.344	95	303
MP01Z#2R2-B--	2.2	365	5.7	296	163	2.254	343	227	2.377	125	287	2.467	93	296
MP01Z#2R3-B--	2.3	350	5.6	292	160	2.358	337	222	2.491	122	281	2.590	91	289
MP01Z#2R4-B--	2.4	340	5.5	287	158	2.462	332	217	2.606	120	274	2.712	89	282
MP01Z#2R5-B--	2.5	330	5.4	282	155	2.566	327	212	2.720	117	268	2.835	87	275
MP01Z#2R6-B--	2.6	320	5.3	277	152	2.670	322	207	2.834	114	262	2.958	85	268
MP01Z#2R7-B--	2.7	310	5.2	272	150	2.773	317	202	2.949	112	255	3.080	83	261
MP01Z#2R8-B--	2.8	300	5.1	269	148	2.878	312	199	3.066	110	252	3.209	81	258
MP01Z#2R9-B--	2.9	295	5.0	265	146	2.983	308	196	3.184	108	248	3.337	80	254
MP01Z#3R0-B--	3	290	4.9	261	144	3.088	304	193	3.301	106	245	3.465	78	251
MP01Z#3R1-B--	3.1	285	4.8	257	141	3.196	299	190	3.419	105	241	3.593	77	247
MP01Z#3R2-B--	3.2	285	4.7	253	139	3.297	295	187	3.536	103	238	3.722	76	244
MP01Z#3R3-B--	3.3	280	4.6	250	137	3.402	291	185	3.654	101	234	3.850	74	240
MP01Z#3R4-B--	3.4	275	4.6	246	135	3.506	286	182	3.771	99	231	3.978	73	237
MP01Z#3R5-B--	3.5	275	4.5	242	133	3.611	282	179	3.889	98	227	4.107	71	233
MP01Z#3R6-B--	3.6	270	4.5	238	131	3.716	278	176	4.006	96	224	4.235	70	230
MP01Z#3R7-B--	3.7	265	4.4	234	129	3.82	273	173	4.124	94	220	4.363	69	226
MP01Z#3R8-B--	3.8	265	4.4	230	127	3.925	269	170	4.241	92	217	4.492	67	223
MP01Z#3R9-B--	3.9	260	4.3	227	125	4.03	265	167	4.359	91	213	4.620	66	219
MP01Z#4R0-B--	4	260	4.3	224	123	4.138	262	165	4.484	89	210	4.760	65	216
MP01Z#4R1-B--	4.1	255	4.2	222	122	4.247	259	162	4.610	88	207	4.901	64	213
MP01Z#4R2-B--	4.2	255	4.2	220	121	4.356	257	159	4.735	87	204	5.041	63	210
MP01Z#4R3-B--	4.3	250	4.1	218	120	4.464	254	157	4.860	86	201	5.181	62	207
MP01Z#4R4-B--	4.4	245	4.1	216	119	4.573	252	154	4.986	85	198	5.322	61	204

"#"-can be either "J" or "K" temperature coefficient

Accu-P® MP Medical Grade



0201 Typical Electrical Tables

Part Number	Capacitance (pF)	ESR Max. mOhm	SRF GHz	Q Standard Value @ 1GHz		Frequency 900MHz			Frequency 1900MHz			Frequency 2400MHz		
				Typ.	Min.	Ceff (pF)	Q Typ.	ESR Typ. (mOhm)	Ceff (pF)	Q Typ.	ESR Typ. (mOhm)	Ceff (pF)	Q Typ.	ESR Typ. (mOhm)
MP01ZK4R5-B--	4.5	240	4.0	214	118	4.682	249	152	5.111	83	195	5.462	60	201
MP01ZK4R6-B--	4.6	235	4.0	212	116	4.790	245	149	5.237	82	192	5.602	59	198
MP01ZK4R7-B--	4.7	230	3.9	209	115	4.899	244	147	5.362	81	189	5.743	58	195
MP01ZK5R1-B--	5.1	225	3.8	201	110	5.334	233	136	5.863	76	178	6.304	54	183
MP01ZK5R6-B--	5.6	220	3.6	190	105	5.877	220	124	6.490	70	163	7.006	49	168
MP01ZK6R2-B--	6.2	215	3.5	177	97	6.488	208	126	7.290	65	167	7.993	45	174
MP01ZK6R8-B--	6.8	210	3.3	164	90	7.100	195	128	8.090	60	171	8.980	41	179
MP01ZK7R5-B--	7.5	205	3.2	153	84	7.901	182	125	9.129	56	166	10.27	38	173
MP01ZK8R2-B--	8.2	200	3.0	142	78	8.701	168	121	10.17	52	160	11.56	34	167
MP01ZK9R1-B--	9.1	195	2.9	135	74	9.676	159	118	11.57	49	154	13.49	32	161
MP01ZK100-B--	10	190	2.8	128	70	10.65	151	114	12.96	45	148	15.41	29	155
MP01ZK110-B--	11	185	2.7	120	66	11.73	141	110	14.52	42	142	17.55	27	148
MP01ZK120-B--	12	180	2.5	112	62	12.82	132	105	16.07	39	135	19.68	24	141
MP01ZK130-B--	13	175	2.4	105	58	13.92	124	104	17.82	36	135	22.38	22	142
MP01ZK140-B--	14	170	2.4	98	54	15.02	116	103	19.57	32	135	25.08	19	142
MP01ZK150-B--	15	165	2.3	91	50	16.12	108	102	21.32	29	135	27.78	17	143
MP01ZK160-B--	16	165	2.2	86	47	17.37	102	103	24.04	27	135	N/A	N/A	N/A
MP01ZK170-B--	17	160	2.2	81	44	18.63	96	105	26.76	25	136	N/A	N/A	N/A
MP01ZK180-B--	18	160	2.1	76	42	19.88	90	106	29.48	23	136	N/A	N/A	N/A
MP01ZK190-B--	19	155	2.1	71	39	21.14	83	108	32.20	21	136	N/A	N/A	N/A
MP01ZK200-B--	20	155	2.1	65	36	22.39	77	109	34.92	19	136	N/A	N/A	N/A
MP01ZK210-B--	21	150	2.0	66	33	23.5	71	110	37.41	17	137	N/A	N/A	N/A
MP01ZK220-B--	22	150	2.0	55	30	24.9	65	112	40.36	15	137	N/A	N/A	N/A
UR = 16V (Voltage code Y)														
MP01Y#R05-B--	0.05	N/A	20.9	599	402	0.055	650	3220	0.056	265	4010	0.057	195	4450
MP01Y#R15-B--	0.1	6000	19.4	574	316	0.110	614	3682	0.112	246	3036	0.113	188	3113
MP01Y#R25-B--	0.15	4800	17.9	510	280	0.163	550	2087	0.166	220	2404	0.168	170	2441
MP01Y#R35-B--	0.2	3600	16.4	445	245	0.216	520	1693	0.220	210	1971	0.223	160	1970
MP01Y#R45-B--	0.25	2700	15.5	436	240	0.262	510	1371	0.268	204	1604	0.272	153	1646
MP01Y#R55-B--	0.3	1800	14.6	427	235	0.309	500	1149	0.316	199	1337	0.320	146	1421
MP01Y#R65-B--	0.35	1650	14.1	423	232	0.360	494	1001	0.369	196	1177	0.374	144	1265
MP01Y#R75-B--	0.4	1500	12.5	418	230	0.411	489	874	0.421	193	1038	0.427	142	1129
MP01Y#R85-B--	0.45	1400	11.9	413	227	0.461	484	819	0.473	191	972	0.481	140	1066
MP01Y#R95-B--	0.5	1300	11.3	408	224	0.512	478	765	0.526	188	906	0.535	138	1003
MP01Y#R105-B--	0.55	1200	10.9	403	222	0.563	473	710	0.578	186	840	0.588	137	940
MP01Y#R115-B--	0.6	1100	10.4	398	219	0.614	468	655	0.631	183	791	0.642	135	882
MP01Y#R125-B--	0.65	1025	10.0	394	217	0.664	462	600	0.683	181	742	0.695	133	825
MP01Y#R135-B--	0.7	950	9.5	389	214	0.715	457	545	0.735	178	693	0.749	131	767
MP01Y#R145-B--	0.75	900	9.3	384	211	0.766	452	490	0.788	176	644	0.802	129	729
MP01Y#R155-B--	0.8	850	9.1	379	209	0.817	446	435	0.840	173	635	0.856	127	692
MP01Y#R165-B--	0.85	825	8.9	374	206	0.868	441	380	0.893	171	606	0.909	126	654
MP01Y#R175-B--	0.9	800	8.8	370	203	0.918	436	325	0.945	168	577	0.963	124	616
MP01Y#R185-B--	0.95	775	8.6	365	201	0.969	430	270	0.998	166	548	1.016	122	579
MP01Y#R195-B--	1	750	8.4	360	198	1.020	425	215	1.050	163	519	1.070	120	541
Contact Factory	1.05	725	8.2	358	197	1.078	421	160	1.112	161	502	1.134	119	523
MP01Y#R205-B--	1.1	700	8.0	355	195	1.135	418	105	1.173	159	486	1.199	117	505
Contact Factory	1.15	650	7.8	353	194	1.193	414	50	1.235	157	469	1.263	116	488
MP01Y#R215-B--	1.2	600	7.6	350	193	1.251	411	0	1.296	155	452	1.327	115	470
Contact Factory	1.25	580	7.5	348	191	1.308	407	0	1.358	153	436	1.392	114	452
MP01Y#R225-B--	1.3	560	7.4	345	190	1.355	403	0	1.419	151	419	1.456	112	434
Contact Factory	1.35	545	7.3	343	189	1.424	400	0	1.481	149	402	1.520	111	416
MP01Y#R235-B--	1.4	530	7.2	340	187	1.481	396	0	1.542	147	386	1.585	110	398
Contact Factory	1.45	515	7.1	338	186	1.539	393	0	1.604	145	369	1.649	109	381
MP01Y#R245-B--	1.5	500	7.0	335	184	1.597	389	0	1.665	144	353	1.713	107	363
UR = 16V (Voltage code Y)														
Contact Factory	1.55	490	6.8	332	183	1.642	386	0	1.714	142	347	1.764	106	358
MP01Y#R255-B--	1.6	480	6.7	330	181	1.687	382	0	1.762	141	342	1.815	105	352
Contact Factory	1.66	470	6.6	327	180	1.732	378	0	1.810	140	337	1.866	104	347
MP01Y#R265-B--	1.7	460	6.5	324	178	1.777	375	0	1.859	138	331	1.917	103	342
Contact Factory	1.75	455	6.4	321	176	1.822	371	0	1.907	137	326	1.968	102	337
MP01Y#R275-B--	1.8	450	6.3	318	175	1.866	367	0	1.955	136	321	2.018	101	331
Contact Factory	1.85	438	6.2	315	173	1.911	364	0	2.003	134	316	2.069	100	326
MP01Y#R285-B--	1.9	425	6.2	312	172	1.956	360	0	2.052	133	310	2.120	99	321
Contact Factory	1.95	412	6.1	309	170	2.001	357	0	2.100	132	305	2.171	98	316
MP01Y#R295-B--	2	400	6.0	306	168	2.046	353	0	2.148	131	300	2.222	97	310

"#"-can be either "J" or "K" temperature coefficient



0201 Typical Electrical Tables

Part Number	Capacitance (pF)	ESR Max. mOhm	SRF GHz	Q Standard Value @ 1GHz		Frequency 900MHz			Frequency 1900MHz			Frequency 2400MHz		
				Typ.	Min.	Ceff (pF)	Q Typ.	ESR Typ. (mOhm)	Ceff (pF)	Q Typ.	ESR Typ. (mOhm)	Ceff (pF)	Q Typ.	ESR Typ. (mOhm)
MP01Y#2R1-B--	2.1	380	5.9	301	166	2.150	348	232	2.263	128	293	2.344	95	303
MP01Y#2R2-B--	2.2	365	5.7	296	163	2.254	343	227	2.377	125	287	2.467	93	296
MP01Y#2R3-B--	2.3	350	5.6	292	160	2.358	337	222	2.491	122	281	2.590	91	289
MP01Y#2R4-B--	2.4	340	5.5	287	158	2.462	332	217	2.606	120	274	2.712	89	282
MP01Y#2R5-B--	2.5	330	5.4	282	155	2.566	327	212	2.720	117	268	2.835	87	275
MP01Y#2R6-B--	2.6	320	5.3	277	152	2.670	322	207	2.834	114	262	2.958	85	268
MP01Y#2R7-B--	2.7	310	5.2	272	150	2.773	317	202	2.949	112	255	3.080	83	261
MP01Y#2R8-B--	2.8	300	5.1	269	148	2.878	312	199	3.066	110	252	3.209	81	258
MP01Y#2R9-B--	2.9	295	5.0	265	146	2.983	308	196	3.184	108	248	3.337	80	254
MP01Y#3R0-B--	3	290	4.9	261	144	3.088	304	193	3.301	106	245	3.465	78	251
MP01Y#3R1-B--	3.1	285	4.8	257	141	3.196	299	190	3.419	105	241	3.593	77	247
MP01Y#3R2-B--	3.2	285	4.7	253	139	3.297	295	187	3.536	103	238	3.722	76	244
MP01Y#3R3-B--	3.3	280	4.6	250	137	3.402	291	185	3.654	101	234	3.850	74	240
MP01Y#3R4-B--	3.4	275	4.6	246	135	3.506	286	182	3.771	99	231	3.978	73	237
MP01Y#3R5-B--	3.5	275	4.5	242	133	3.611	282	179	3.889	98	227	4.107	71	233
MP01Y#3R6-B--	3.6	270	4.5	238	131	3.716	278	176	4.006	96	224	4.235	70	230
MP01Y#3R7-B--	3.7	265	4.4	234	129	3.820	273	173	4.124	94	220	4.363	69	226
UR = 25V (Voltage code 3)														
MP013#R05-B--	0.05	N/A	20.9	599	402	0.055	650	3220	0.056	265	4010	0.057	195	4450
MP013#R1-B--	0.1	6000	19.4	574	316	0.110	614	3682	0.112	246	3036	0.113	188	3113
MP013#R15-B--	0.15	4800	17.9	510	280	0.163	550	2087	0.166	220	2404	0.168	170	2441
MP013#R2-B--	0.2	3600	16.4	445	245	0.216	520	1693	0.220	210	1971	0.223	160	1970
MP013#R25-B--	0.25	2700	15.5	436	240	0.262	510	1371	0.268	204	1604	0.272	153	1646
MP013#R3-B--	0.3	1800	14.6	427	235	0.309	500	1149	0.316	199	1337	0.320	146	1421
MP013#R35-B--	0.35	1650	14.1	423	232	0.360	494	1001	0.369	196	1177	0.374	144	1265
MP013#R4-B--	0.4	1500	12.5	418	230	0.411	489	874	0.421	193	1038	0.427	142	1129
MP013#R45-B--	0.45	1400	11.9	413	227	0.461	484	819	0.473	191	972	0.481	140	1066
MP013#R5-B--	0.5	1300	11.3	408	224	0.512	478	765	0.526	188	906	0.535	138	1003
MP013#R55-B--	0.55	1200	10.9	403	222	0.563	473	710	0.578	186	840	0.588	137	940
MP013#R6-B--	0.6	1100	10.4	398	219	0.614	468	657	0.631	183	791	0.642	135	882
MP013#R65-B--	0.65	1025	10.0	394	217	0.664	462	624	0.683	181	742	0.695	133	825
MP013#R7-B--	0.7	950	9.5	389	214	0.715	457	580	0.735	178	693	0.749	131	767
MP013#R75-B--	0.75	900	9.3	384	211	0.766	452	557	0.788	176	664	0.802	129	729
MP013#R8-B--	0.8	850	9.1	379	209	0.817	446	534	0.840	173	635	0.856	127	692
MP013#R85-B--	0.85	825	8.9	374	206	0.868	441	511	0.893	171	606	0.909	126	654
MP013#R9-B--	0.9	800	8.8	370	203	0.918	436	487	0.945	168	577	0.963	124	616
MP013#R95-B--	0.95	775	8.6	365	201	0.969	430	464	0.998	166	548	1.016	122	579
MP013#R10-B--	1	750	8.4	360	198	1.020	425	441	1.050	163	519	1.070	120	541
Contact Factory	1.05	725	8.2	358	197	1.078	421	426	1.112	161	502	1.134	119	523
MP013#R11-B--	1.1	700	8.0	355	195	1.135	418	410	1.173	159	486	1.199	117	505
Contact Factory	1.15	650	7.8	353	194	1.193	414	395	1.235	157	469	1.263	116	488
MP013#R12-B--	1.2	600	7.6	350	193	1.251	411	379	1.296	155	452	1.327	115	470
Contact Factory	1.25	580	7.5	348	191	1.308	407	364	1.358	153	436	1.392	114	452
MP013#R13-B--	1.3	560	7.4	345	190	1.355	403	348	1.419	151	419	1.456	112	434
Contact Factory	1.35	545	7.3	343	189	1.424	400	333	1.481	149	402	1.520	111	416
MP013#R14-B--	1.4	530	7.2	340	187	1.481	396	317	1.542	147	386	1.585	110	398
Contact Factory	1.45	515	7.1	338	186	1.539	393	302	1.604	145	369	1.649	109	381
MP013#R15-B--	1.5	500	7.0	335	184	1.597	389	287	1.665	144	353	1.713	107	363
Contact Factory	1.55	490	6.8	332	183	1.642	386	282	1.714	142	347	1.764	106	358
UR = 25V (Voltage code 3)														
MP013#R16-B--	1.6	480	6.7	330	181	1.687	382	277	1.762	141	342	1.815	105	352
Contact Factory	1.65	470	6.6	327	180	1.732	378	272	1.810	140	337	1.866	104	347
MP013#R17-B--	1.7	460	6.5	324	178	1.777	375	267	1.859	138	331	1.917	103	342
UR = 50V (Voltage code 5)														
MP015#R05-B--	0.05	N/A	20.9	599	402	0.055	650	3220	0.056	265	4010	0.057	195	4450
MP015#R1-B--	0.1	6000	19.4	574	316	0.110	614	3682	0.112	246	3036	0.113	188	3113
MP015#R15-B--	0.15	4800	17.9	510	280	0.163	550	2087	0.166	220	2404	0.168	170	2441
MP015#R2-B--	0.2	3600	16.4	445	245	0.216	520	1693	0.220	210	1971	0.223	160	1970
MP015#R25-B--	0.25	2700	15.5	436	240	0.262	510	1371	0.268	204	1604	0.272	153	1646
MP015#R3-B--	0.3	1800	14.6	427	235	0.309	500	1149	0.316	199	1337	0.320	146	1421
MP015#R35-B--	0.35	1650	14.1	423	232	0.360	494	1001	0.369	196	1177	0.374	144	1265
MP015#R4-B--	0.4	1500	12.5	418	230	0.411	489	874	0.421	193	1038	0.427	142	1129
MP015#R45-B--	0.45	1400	11.9	413	227	0.461	484	819	0.473	191	972	0.481	140	1066
MP015#R5-B--	0.5	1300	11.3	408	224	0.512	478	765	0.526	188	906	0.535	138	1003

"#"=can be either "J" or "K" temperature coefficient

Accu-P[®] MP Medical Grade



0402 Typical Electrical Tables

Part Number	Capacitance (pF)	ESR Max. mOhm	SRF GHz	Q Standard Value @ 1GHz		Frequency 900MHz			Frequency 1900MHz			Frequency 2400MHz		
				Typ.	Min.	Ceff (pF)	Q Typ.	ESR Typ. (mOhm)	Ceff (pF)	Q Typ.	ESR Typ. (mOhm)	Ceff (pF)	Q Typ.	ESR Typ. (mOhm)
U_R = 25V (Voltage code 3)														
MP023#R05-B--	0.05	N/A	20.9	856	471	0.06	881	1411	0.06	562	1216	0.06	498	983
MP023#R1-B--	0.1	6000	19.4	848	466	0.11	873	1316	0.11	554	1115	0.11	490	914
MP023#R15-B--	0.15	4800	17.9	840	462	0.16	866	1222	0.16	547	1013	0.16	482	845
MP023#R2-B--	0.2	3600	16.4	832	457	0.21	858	1128	0.21	539	912	0.22	474	776
MP023#R25-B--	0.25	2700	15.5	823	453	0.26	850	1033	0.27	523	810	0.27	465	707
MP023#R3-B--	0.3	1800	14.6	815	448	0.31	842	939	0.32	525	708	0.32	457	638
MP023#R35-B--	0.35	1650	14.1	807	444	0.36	834	844	0.37	517	607	0.37	449	569
MP023#R4-B--	0.4	1500	125.0	799	439	0.41	827	750	0.42	510	505	0.42	441	500
MP023#R45-B--	0.45	1400	11.9	791	435	0.46	819	667	0.47	502	458	0.48	432	453
MP023#R5-B--	0.5	1300	11.3	783	430	0.51	811	583	0.52	495	410	0.53	424	407
MP023#R55-B--	0.55	1200	10.9	774	426	0.57	803	500	0.57	487	363	0.58	416	360
MP023#R6-B--	0.6	1100	10.4	766	421	0.62	796	465	0.62	480	343	0.63	408	339
MP023#R65-B--	0.65	1025	10.0	758	417	0.67	788	431	0.67	472	322	0.68	399	317
MP023#R7-B--	0.7	950	9.5	750	413	0.72	780	396	0.72	465	302	0.73	391	296
MP023#R75-B--	0.75	900	9.3	746	410	0.77	776	375	0.78	456	290	0.79	381	285
MP023#R8-B--	0.8	850	9.1	743	408	0.82	772	354	0.83	447	277	0.84	370	273
MP023#R85-B--	0.85	800	9.0	739	406	0.87	768	334	0.88	438	265	0.89	360	262
MP023#R9-B--	0.9	750	8.8	735	404	0.92	764	313	0.93	429	253	0.95	350	250
MP023#R95-B--	0.95	712	8.4	732	402	0.97	760	292	0.98	420	240	1.00	339	239
MP023#1R0-B--	1	675	8.0	728	400	1.02	756	271	1.04	411	228	1.05	329	227
Contact Factory	1.05	638	7.9	725	398	1.07	752	258	1.09	406	221	1.11	323	221
MP023#1R1-B--	1.1	600	7.8	721	397	1.12	749	245	1.14	401	214	1.16	318	214
Contact Factory	1.15	575	7.6	718	395	1.17	745	232	1.20	396	207	1.22	312	208
MP023#1R2-B--	1.2	550	7.4	714	393	1.22	742	218	1.25	391	200	1.27	306	202
Contact Factory	1.25	525	7.2	711	391	1.27	738	205	1.31	386	193	1.32	301	195
MP023#1R3-B--	1.3	500	7.0	707	389	1.32	734	192	1.36	381	185	1.38	295	189
Contact Factory	1.35	485	6.9	704	387	1.37	731	179	1.41	376	178	1.43	289	183
MP023#1R4-B--	1.4	470	6.8	700	385	1.42	727	165	1.47	371	171	1.49	283	177
Contact Factory	1.45	460	6.7	697	383	1.47	724	152	1.52	366	164	1.54	278	170
MP023#1R5-B--	1.5	450	6.5	693	381	1.52	720	139	1.58	361	157	1.60	272	164
Contact Factory	1.55	440	6.5	690	379	1.56	716	135	1.62	358	153	1.65	269	159
MP023#1R6-B--	1.6	430	6.5	686	377	1.61	716	130	1.67	355	148	1.70	267	155
Contact Factory	1.65	422	6.5	683	375	1.66	709	126	1.72	352	143	1.76	264	150
MP023#1R7-B--	1.7	415	6.4	679	373	1.71	705	122	1.77	349	139	1.81	267	146
Contact Factory	1.75	408	6.3	676	372	1.75	702	118	1.82	347	134	1.86	259	141
MP023#1R8-B--	1.8	400	6.2	672	370	1.80	698	113	1.87	344	130	1.92	256	137
Contact Factory	1.85	395	6.1	669	368	1.85	694	109	1.92	341	125	1.97	253	132
MP023#1R9-B--	1.9	390	6.0	665	366	1.90	690	105	1.97	338	121	2.02	251	128
Contact Factory	1.95	385	5.9	662	364	1.94	687	101	2.01	335	116	2.08	248	123
MP023#2R0-B--	2	380	5.7	658	362	1.99	683	96	2.06	332	112	2.13	245	119
MP023#2R1-B--	2.1	370	5.4	651	358	2.10	676	93	2.18	326	108	2.26	241	115
MP023#2R2-B--	2.2	360	5.1	643	354	2.21	669	89	2.30	321	104	2.38	236	112
MP023#2R3-B--	2.3	350	5.0	636	350	2.31	662	85	2.42	315	101	2.51	231	109
MP023#2R4-B--	2.4	340	4.9	629	346	2.42	656	81	2.54	309	97	2.64	226	106
MP023#2R5-B--	2.5	330	4.7	622	342	2.53	649	77	2.65	303	94	2.76	221	102
MP023#2R6-B--	2.6	320	4.6	614	338	2.64	642	74	2.77	298	90	2.89	216	99
MP023#2R7-B--	2.7	310	4.5	607	334	2.75	635	70	2.89	292	86	3.02	211	96
MP023#2R8-B--	2.8	300	4.5	600	330	2.85	628	68	3.01	288	83	3.15	207	92
MP023#2R9-B--	2.9	295	4.4	592	326	2.95	621	66	3.13	283	80	3.28	203	88
MP023#3R0-B--	3	280	4.4	585	322	3.06	614	64	3.24	279	76	3.41	200	84
MP023#3R1-B--	3.1	275	4.4	578	318	3.16	607	62	3.36	274	73	3.54	196	80
MP023#3R2-B--	3.2	275	4.3	570	314	3.27	600	60	3.48	270	70	3.67	192	76
MP023#3R3-B--	3.3	270	4.3	563	310	3.37	593	58	3.60	265	67	3.80	188	72
MP023#3R4-B--	3.4	265	4.3	556	306	3.47	586	57	3.71	261	63	3.93	184	68
MP023#3R5-B--	3.5	260	4.2	548	302	3.58	579	55	3.83	256	60	4.06	180	64
MP023#3R6-B--	3.6	255	4.2	541	298	3.68	572	53	3.95	252	57	4.19	177	60
MP023#3R7-B--	3.7	250	4.1	534	294	3.78	565	51	4.06	247	54	4.32	173	56
MP023#3R8-B--	3.8	245	4.0	526	289	3.89	558	49	4.18	243	50	4.45	169	52
MP023#3R9-B--	3.9	240	3.9	519	285	3.99	551	47	4.30	238	47	4.58	165	48
MP02Z#4R0-B--	4	235	3.9	513	282	4.10	545	47	4.42	235	47	4.73	162	48
MP02Z#4R1-B--	4.1	235	3.8	507	279	4.20	539	47	4.55	232	46	4.87	160	48
MP02Z#4R2-B--	4.2	230	3.8	501	275	4.30	534	46	4.67	228	46	5.01	157	48
MP02Z#4R3-B--	4.3	225	3.7	495	272	4.41	528	46	4.79	225	46	5.16	154	48
MP02Z#4R4-B--	4.4	220	3.7	489	269	4.51	522	46	4.92	222	46	5.30	151	47

"#"-can be either "J" or "K" temperature coefficient



0402 Typical Electrical Tables

Part Number	Capacitance (pF)	ESR Max. mOhm	SRF GHz	Q Standard Value @ 1GHz		Frequency 900MHz			Frequency 1900MHz			Frequency 2400MHz		
				Typ.	Min.	Ceff (pF)	Q Typ.	ESR Typ. (mOhm)	Ceff (pF)	Q Typ.	ESR Typ. (mOhm)	Ceff (pF)	Q Typ.	ESR Typ. (mOhm)
MP02Z#4R5-B--	4.5	215	3.6	483	265	4.61	516	46	5.04	219	45	5.44	149	47
MP02Z#4R6-B--	4.6	215	3.6	477	262	4.72	511	45	5.16	216	45	5.59	146	47
MP02Z#4R7-B--	4.7	210	3.5	471	259	4.82	505	45	5.29	213	45	5.73	143	47
MP02Z#5R1-B--	5.1	205	3.4	446	245	5.23	482	44	5.78	200	43	6.30	133	47
MP02Z#5R6-B--	5.6	200	3.3	416	229	5.75	453	43	6.40	184	42	7.02	119	46
MP02Z#6R2-B--	6.2	195	3.0	488	213	6.41	427	44	7.26	167	44	8.11	107	47
MP02Z#6R8-B--	6.8	190	2.8	360	198	7.07	400	44	8.12	150	45	9.19	95	48
MP02Z#7R5-B--	7.5	185	2.7	338	186	7.85	378	45	9.17	139	47	10.57	86	49
MP02Z#8R2-B--	8.2	180	2.6	315	173	8.62	356	45	10.22	128	48	11.95	77	50
MP02Z#9R1-B--	9.1	175	2.5	292	160	9.63	333	45	11.75	115	47	14.23	69	50
MP02Z#100-B--	10	170	2.4	268	148	10.65	310	45	13.28	103	47	16.50	61	49
MP02Z#110-B--	11	170	2.3	242	133	11.77	285	44	14.98	89	46	19.04	51	49
MP02Z#120-B--	12	165	2.2	217	119	12.90	259	44	16.68	75	45	21.57	42	48
MP02ZK130-B--	13	165	2.2	202	111	14.03	241	44	18.83	68	47	25.73	38	49
MP02ZK140-B--	14	160	2.1	187	103	15.17	223	44	20.97	62	49	29.89	33	49
MP02ZK150-B--	15	160	2.1	173	94	16.30	204	45	23.12	56	51	34.05	29	50
MP02ZK160-B--	16	155	2.0	157	87	17.53	187	44	25.91	50	49	41.44	25	49
MP02ZK170-B--	17	155	1.9	143	79	18.75	169	43	28.70	45	46	48.82	21	47
MP02ZK180-B--	18	150	1.8	129	71	19.98	152	42	31.49	39	44	56.21	17	46
MP02ZK190-B--	19	150	1.8	121	67	21.11	143	42	33.51	36	44	60.92	15	47
MP02ZK200-B--	20	145	1.8	110	61	22.25	131	41	35.53	33	43	65.63	14	48
MP02ZK220-B--	22	145	1.8	98	54	24.51	116	41	39.57	26	42	75.05	10	51
MP02ZK240-B--	24	140	1.8	87	48	27.51	104	37	54.94	21	35	N/A	N/A	N/A
MP02ZK270-B--	27	140	1.7	70	39	32.01	85	32	77.98	13	23	N/A	N/A	N/A
MP02ZK300-B--	30	135	1.7	65	36	35.89	78	28	106.50	10	12	N/A	N/A	N/A
MP02ZK330-B--	33	135	1.7	60	33	40.05	74	27	N/A	N/A	N/A	N/A	N/A	N/A
MP02ZK390-B--	39	130	1.7	56	31	50.21	69	28	N/A	N/A	N/A	N/A	N/A	N/A
MP02ZK470-B--	47	130	1.6	50	28	63.75	63	30	N/A	N/A	N/A	N/A	N/A	N/A
MP02ZK560-B--	56	130	1.6	44	24	78.99	56	33	N/A	N/A	N/A	N/A	N/A	N/A
MP02ZK680-B--	68	130	1.6	32	18	106.28	42	40	N/A	N/A	N/A	N/A	N/A	N/A
U_R = 16V (Voltage code Y)														
MP02Y#R05-B--	0.05	N/A	20.9	856	471	0.06	881	1411	0.06	562	1216	0.06	498	983
MP02Y#OR1-B--	0.1	6000	19.4	848	466	0.11	873	1316	0.11	554	1115	0.11	490	914
MP02Y#R15-B--	0.15	4800	17.9	840	462	0.16	866	1222	0.16	547	1013	0.16	482	845
MP02Y#OR2-B--	0.2	3600	16.4	832	457	0.21	858	1128	0.21	539	912	0.22	474	776
MP02Y#R25-B--	0.25	2700	15.5	823	453	0.26	850	1033	0.27	523	810	0.27	465	707
MP02Y#OR3-B--	0.3	1800	14.6	815	448	0.31	842	939	0.32	525	708	0.32	457	638
MP02Y#R35-B--	0.35	1650	14.1	807	444	0.36	834	844	0.37	517	607	0.37	449	569
MP02Y#OR4-B--	0.4	1500	125.0	799	439	0.41	827	750	0.42	510	505	0.42	441	500
MP02Y#R45-B--	0.45	1400	11.9	791	435	0.46	819	667	0.47	502	458	0.48	432	453
MP02Y#OR5-B--	0.5	1300	11.3	783	430	0.51	811	583	0.52	495	410	0.53	424	407
MP02Y#R55-B--	0.55	1200	10.9	774	426	0.57	803	500	0.57	487	363	0.58	416	360
MP02Y#OR6-B--	0.6	1100	10.4	766	421	0.62	796	465	0.62	480	343	0.63	408	339
MP02Y#R65-B--	0.65	1025	10.0	758	417	0.67	788	431	0.67	472	322	0.68	399	317
MP02Y#OR7-B--	0.7	950	9.5	750	413	0.72	780	396	0.72	465	302	0.73	391	296
MP02Y#R75-B--	0.75	900	9.3	746	410	0.77	776	375	0.78	456	290	0.79	381	285
MP02Y#OR8-B--	0.8	850	9.1	743	408	0.82	772	354	0.83	447	277	0.84	370	273
MP02Y#R85-B--	0.85	800	9.0	739	406	0.87	768	334	0.88	438	265	0.89	360	262
MP02Y#OR9-B--	0.9	750	8.8	735	404	0.92	764	313	0.93	429	253	0.95	350	250
MP02Y#R95-B--	0.95	712	8.4	732	402	0.97	760	292	0.98	420	240	1.00	339	239
MP02Y#1R0-B--	1	675	8.0	728	400	1.02	756	271	1.04	411	228	1.05	329	227
Contact Factory	1.05	638	7.9	725	398	1.07	752	258	1.09	406	221	1.11	323	221
MP02Y#1R1-B--	1.1	600	7.8	721	397	1.12	749	245	1.14	401	214	1.16	318	214
Contact Factory	1.15	575	7.6	718	395	1.17	745	232	1.20	396	207	1.22	312	208
U_R = 16V (Voltage code Y)														
MP02Y#1R2-B--	1.2	550	7.4	714	393	1.22	742	218	1.25	391	200	1.27	306	202
Contact Factory	1.25	525	7.2	711	391	1.27	738	205	1.31	386	193	1.32	301	195
MP02Y#1R3-B--	1.3	500	7.0	707	389	1.32	734	192	1.36	381	185	1.38	295	189
Contact Factory	1.35	485	6.9	704	387	1.37	731	179	1.41	376	178	1.43	289	183
MP02Y#1R4-B--	1.4	470	6.8	700	385	1.42	727	165	1.47	371	171	1.49	283	177
Contact Factory	1.45	460	6.7	697	383	1.47	724	152	1.52	366	164	1.54	278	170
MP02Y#1R5-B--	1.5	450	6.5	693	381	1.52	720	139	1.58	361	157	1.60	272	164
Contact Factory	1.55	440	6.5	690	379	1.56	716	135	1.62	358	153	1.65	269	159
MP02Y#1R6-B--	1.6	430	6.5	686	377	1.61	716	130	1.67	355	148	1.70	267	155
Contact Factory	1.65	422	6.5	683	375	1.66	709	126	1.72	352	143	1.76	264	150

"#"-can be either "J" or "K" temperature coefficient

0402 Typical Electrical Tables

Part Number	Capacitance (pF)	ESR Max. mOhm	SRF GHz	Q Standard Value @ 1GHz		Frequency 900MHz			Frequency 1900MHz			Frequency 2400MHz		
				Typ.	Min.	Ceff (pF)	Q Typ.	ESR Typ. (mOhm)	Ceff (pF)	Q Typ.	ESR Typ. (mOhm)	Ceff (pF)	Q Typ.	ESR Typ. (mOhm)
MP02Y#1R7-B--	1.7	415	6.4	679	373	1.71	705	122	1.77	349	139	1.81	267	146
Contact Factory	1.75	408	6.3	676	372	1.75	702	118	1.82	347	134	1.86	259	141
MP02Y#1R8-B--	1.8	400	6.2	672	370	1.80	698	113	1.87	344	130	1.92	256	137
Contact Factory	1.85	395	6.1	669	368	1.85	694	109	1.92	341	125	1.97	253	132
MP02Y#1R9-B--	1.9	390	6.0	665	366	1.90	690	105	1.97	338	121	2.02	251	128
Contact Factory	1.95	385	5.9	662	364	1.94	687	101	2.01	335	116	2.08	248	123
MP02Y#2R0-B--	2	380	5.7	658	362	1.99	683	96	2.06	332	112	2.13	245	119
MP02Y#2R1-B--	2.1	370	5.4	651	358	2.10	676	93	2.18	326	108	2.26	241	115
MP02Y#2R2-B--	2.2	360	5.1	643	354	2.21	669	89	2.30	321	104	2.38	236	112
MP02Y#2R3-B--	2.3	350	5.0	636	350	2.31	662	85	2.42	315	101	2.51	231	109
MP02Y#2R4-B--	2.4	340	4.9	629	346	2.42	656	81	2.54	309	97	2.64	226	106
MP02Y#2R5-B--	2.5	330	4.7	622	342	2.53	649	77	2.65	303	94	2.76	221	102
MP02Y#2R6-B--	2.6	320	4.6	614	338	2.64	642	74	2.77	298	90	2.89	216	99
MP02Y#2R7-B--	2.7	310	4.5	607	334	2.75	635	70	2.89	292	86	3.02	211	96
MP02Y#2R8-B--	2.8	300	4.5	600	330	2.85	628	68	3.01	288	83	3.15	207	92
MP02Y#2R9-B--	2.9	295	4.4	592	326	2.95	621	66	3.13	283	80	3.28	203	88
MP02Y#3R0-B--	3	280	4.4	585	322	3.06	614	64	3.24	279	76	3.41	200	84
MP02Y#3R1-B--	3.1	275	4.4	578	318	3.16	607	62	3.36	274	73	3.54	196	80
MP02Y#3R2-B--	3.2	275	4.3	570	314	3.27	600	60	3.48	270	70	3.67	192	76
MP02Y#3R3-B--	3.3	270	4.3	563	310	3.37	593	58	3.60	265	67	3.80	188	72
MP02Y#3R4-B--	3.4	265	4.3	556	306	3.47	586	57	3.71	261	63	3.93	184	68
MP02Y#3R5-B--	3.5	260	4.2	548	302	3.58	579	55	3.83	256	60	4.06	180	64
MP02Y#3R6-B--	3.6	255	4.2	541	298	3.68	572	53	3.95	252	57	4.19	177	60
MP02Y#3R7-B--	3.7	250	4.1	534	294	3.78	565	51	4.06	247	54	4.32	173	56
MP02Y#3R8-B--	3.8	245	4.0	526	289	3.89	558	49	4.18	243	50	4.45	169	52
MP02Y#3R9-B--	3.9	240	3.9	519	285	3.99	551	47	4.30	238	47	4.58	165	48
MP02Y#4R0-B--	4	235	3.9	513	282	4.10	545	47	4.42	235	47	4.73	162	48
MP02Y#4R1-B--	4.1	235	3.8	507	279	4.20	539	47	4.55	232	46	4.87	160	48
MP02Y#4R2-B--	4.2	230	3.8	501	275	4.30	534	46	4.67	228	46	5.01	157	48
MP02Y#4R3-B--	4.3	225	3.7	495	272	4.41	528	46	4.79	225	46	5.16	154	48
MP02Y#4R4-B--	4.4	220	3.7	489	269	4.51	522	46	4.92	222	46	5.30	151	47
MP02Y#4R5-B--	4.5	215	3.6	483	265	4.61	516	46	5.04	219	45	5.44	149	47
MP02Y#4R6-B--	4.6	215	3.6	477	262	4.72	511	45	5.16	216	45	5.59	146	47
MP02Y#4R7-B--	4.7	210	3.5	471	259	4.82	505	45	5.29	213	45	5.73	143	47
MP02Y#5R1-B--	5.1	205	3.4	446	245	5.23	482	44	5.78	200	43	6.30	133	47
MP02Y#5R6-B--	5.6	200	3.3	416	229	5.75	453	43	6.40	184	42	7.02	119	46
MP02Y#6R2-B--	6.2	195	3.0	488	213	6.41	427	44	7.26	167	44	8.11	107	47
MP02Y#6R8-B--	6.8	190	2.8	360	198	7.07	400	44	8.12	150	45	9.19	95	48
MP02Y#7R5-B--	7.5	185	2.7	338	186	7.85	378	45	9.17	139	47	10.57	86	49
MP02Y#8R2-B--	8.2	180	2.6	315	173	8.62	356	45	10.22	128	48	11.95	77	50
MP02Y#9R1-B--	9.1	175	2.5	292	160	9.63	333	45	11.75	115	47	14.23	69	50
MP02Y#100-B--	10	170	2.4	268	148	10.65	310	45	13.28	103	47	16.50	61	49
MP02Y#110-B--	11	170	2.3	242	133	11.77	285	44	14.98	89	46	19.04	51	49
MP02Y#120-B--	12	165	2.2	217	119	12.90	259	44	16.68	75	45	21.57	42	48
MP02YK130-B--	13	165	2.2	202	111	14.03	241	44	18.83	68	47	25.73	38	49
MP02YK140-B--	14	160	2.1	187	103	15.17	223	44	20.97	62	49	29.89	33	49
MP02YK150-B--	15	160	2.1	173	94	16.30	204	45	23.12	56	51	34.05	29	50
MP02-K160-B--	16	155	2.0	157	87	17.53	187	44	25.91	50	49	41.44	25	49
MP02YK170-B--	17	155	1.9	143	79	18.75	169	43	28.70	45	46	48.82	21	47
Ur = 25V (Voltage code 3)														
MP023#R05-B--	0.05	N/A	20.9	856	471	0.06	881	1411	0.06	562	1216	0.06	498	983
MP023#R1-B--	0.1	6000	19.4	848	466	0.11	873	1316	0.11	554	1115	0.11	490	914
MP023#R15-B--	0.15	4800	17.9	840	462	0.16	866	1222	0.16	547	1013	0.16	482	845
MP023#R2-B--	0.2	3600	16.4	832	457	0.21	858	1128	0.21	539	912	0.22	474	776
MP023#R25-B--	0.25	2700	15.5	823	453	0.26	850	1033	0.27	523	810	0.27	465	707
MP023#R3-B--	0.3	1800	14.6	815	448	0.31	842	939	0.32	525	708	0.32	457	638
MP023#R35-B--	0.35	1650	14.1	807	444	0.36	834	844	0.37	517	607	0.37	449	569
MP023#R4-B--	0.4	1500	125.0	799	439	0.41	827	750	0.42	510	505	0.42	441	500
MP023#R45-B--	0.45	1400	11.9	791	435	0.46	819	667	0.47	502	458	0.48	432	453
MP023#R5-B--	0.5	1300	11.3	783	430	0.51	811	583	0.52	495	410	0.53	424	407
MP023#R55-B--	0.55	1200	10.9	774	426	0.57	803	500	0.57	487	363	0.58	416	360
MP023#R6-B--	0.6	1100	10.4	766	421	0.62	796	465	0.62	480	343	0.63	408	339
MP023#R65-B--	0.65	1025	10.0	758	417	0.67	788	431	0.67	472	322	0.68	399	317
MP023#R7-B--	0.7	950	9.5	750	413	0.72	780	396	0.72	465	302	0.73	391	296
MP023#R75-B--	0.75	900	9.3	746	410	0.77	776	375	0.78	456	290	0.79	381	285

"#"-can be either "J" or "K" temperature coefficient

0402 Typical Electrical Tables

Part Number	Capacitance (pF)	ESR Max. mOhm	SRF GHz	Q Standard Value @ 1GHz		Frequency 900MHz			Frequency 1900MHz			Frequency 2400MHz		
				Typ.	Min.	Ceff (pF)	Q Typ.	ESR Typ. (mOhm)	Ceff (pF)	Q Typ.	ESR Typ. (mOhm)	Ceff (pF)	Q Typ.	ESR Typ. (mOhm)
MP023#0R8-B--	0.8	850	9.1	743	408	0.82	772	354	0.83	447	277	0.84	370	273
MP023#R85-B--	0.85	800	9.0	739	406	0.87	768	334	0.88	438	265	0.89	360	262
MP023#0R9-B--	0.9	750	8.8	735	404	0.92	764	313	0.93	429	253	0.95	350	250
MP023#R95-B--	0.95	712	8.4	732	402	0.97	760	292	0.98	420	240	1.00	339	239
MP023#1R0-B--	1	675	8.0	728	400	1.02	756	271	1.04	411	228	1.05	329	227
Contact Factory	1.05	638	7.9	725	398	1.07	752	258	1.09	406	221	1.11	323	221
MP023#1R1-B--	1.1	600	7.8	721	397	1.12	749	245	1.14	401	214	1.16	318	214
Contact Factory	1.15	575	7.6	718	395	1.17	745	232	1.20	396	207	1.22	312	208
MP023#1R2-B--	1.2	550	7.4	714	393	1.22	742	218	1.25	391	200	1.27	306	202
Contact Factory	1.25	525	7.2	711	391	1.27	738	205	1.31	386	193	1.32	301	195
MP023#1R3-B--	1.3	500	7.0	707	389	1.32	734	192	1.36	381	185	1.38	295	189
Contact Factory	1.35	485	6.9	704	387	1.37	731	179	1.41	376	178	1.43	289	183
MP023#1R4-B--	1.4	470	6.8	700	385	1.42	727	165	1.47	371	171	1.49	283	177
Contact Factory	1.45	460	6.7	697	383	1.47	724	152	1.52	366	164	1.54	278	170
MP023#1R5-B--	1.5	450	6.5	693	381	1.52	720	139	1.58	361	157	1.60	272	164
Contact Factory	1.55	440	6.5	690	379	1.56	716	135	1.62	358	153	1.65	269	159
MP023#1R6-B--	1.6	430	6.5	686	377	1.61	716	130	1.67	355	148	1.70	267	155
Contact Factory	1.65	422	6.5	683	375	1.66	709	126	1.72	352	143	1.76	264	150
MP023#1R7-B--	1.7	415	6.4	679	373	1.71	705	122	1.77	349	139	1.81	267	146
Contact Factory	1.75	408	6.3	676	372	1.75	702	118	1.82	347	134	1.86	259	141
MP023#1R8-B--	1.8	400	6.2	672	370	1.80	698	113	1.87	344	130	1.92	256	137
Contact Factory	1.85	395	6.1	669	368	1.85	694	109	1.92	341	125	1.97	253	132
MP023#1R9-B--	1.9	390	6.0	665	366	1.90	690	105	1.97	338	121	2.02	251	128
Contact Factory	1.95	385	5.9	662	364	1.94	687	101	2.01	335	116	2.08	248	123
MP023#2R0-B--	2	380	5.7	658	362	1.99	683	96	2.06	332	112	2.13	245	119
MP023#2R1-B--	2.1	370	5.4	651	358	2.10	676	93	2.18	326	108	2.26	241	115
MP023#2R2-B--	2.2	360	5.1	643	354	2.21	669	89	2.30	321	104	2.38	236	112
MP023#2R3-B--	2.3	350	5.0	636	350	2.31	662	85	2.42	315	101	2.51	231	109
MP023#2R4-B--	2.4	340	4.9	629	346	2.42	656	81	2.54	309	97	2.64	226	106
MP023#2R5-B--	2.5	330	4.7	622	342	2.53	649	77	2.65	303	94	2.76	221	102
MP023#2R6-B--	2.6	320	4.6	614	338	2.64	642	74	2.77	298	90	2.89	216	99
MP023#2R7-B--	2.7	310	4.5	607	334	2.75	635	70	2.89	292	86	3.02	211	96
MP023#2R8-B--	2.8	300	4.5	600	330	2.85	628	68	3.01	288	83	3.15	207	92
MP023#2R9-B--	2.9	295	4.4	592	326	2.95	621	66	3.13	283	80	3.28	203	88
MP023#3R0-B--	3	280	4.4	585	322	3.06	614	64	3.24	279	76	3.41	200	84
MP023#3R1-B--	3.1	275	4.4	578	318	3.16	607	62	3.36	274	73	3.54	196	80
MP023#3R2-B--	3.2	275	4.3	570	314	3.27	600	60	3.48	270	70	3.67	192	76
MP023#3R3-B--	3.3	270	4.3	563	310	3.37	593	58	3.60	265	67	3.80	188	72
MP023#3R4-B--	3.4	265	4.3	556	306	3.47	586	57	3.71	261	63	3.93	184	68
MP023#3R5-B--	3.5	260	4.2	548	302	3.58	579	55	3.83	256	60	4.06	180	64
MP023#3R6-B--	3.6	255	4.2	541	298	3.68	572	53	3.95	252	57	4.19	177	60
MP023#3R7-B--	3.7	250	4.1	534	294	3.78	565	51	4.06	247	54	4.32	173	56
MP023#3R8-B--	3.8	245	4.0	526	289	3.89	558	49	4.18	243	50	4.45	169	52
MP023#3R9-B--	3.9	240	3.9	519	285	3.99	551	47	4.30	238	47	4.58	165	48
U_R = 25V (Voltage code 3)														
MP023#4R0-B--	4	235	3.9	513	282	4.10	545	47	4.42	235	47	4.73	162	48
MP023#4R1-B--	4.1	235	3.8	507	279	4.20	539	47	4.55	232	46	4.87	160	48
MP023#4R2-B--	4.2	230	3.8	501	275	4.30	534	46	4.67	228	46	5.01	157	48
MP023#4R3-B--	4.3	225	3.7	495	272	4.41	528	46	4.79	225	46	5.16	154	48
MP023#4R4-B--	4.4	220	3.7	489	269	4.51	522	46	4.92	222	46	5.30	151	47
MP023#4R5-B--	4.5	215	3.6	483	265	4.61	516	46	5.04	219	45	5.44	149	47
MP023#4R6-B--	4.6	215	3.6	477	262	4.72	511	45	5.16	216	45	5.59	146	47
MP023#4R7-B--	4.7	210	3.5	471	259	4.82	505	45	5.29	213	45	5.73	143	47
MP023#5R1-B--	5.1	205	3.4	446	245	5.23	482	44	5.78	200	43	6.30	133	47
MP023#5R6-B--	5.6	200	3.3	416	229	5.75	453	43	6.40	184	42	7.02	119	46
MP023#6R2-B--	6.2	195	3.0	488	213	6.41	427	44	7.26	167	44	8.11	107	47
MP023#6R8-B--	6.8	190	2.8	360	198	7.07	400	44	8.12	150	45	9.19	95	48
MP023#7R5-B--	7.5	185	2.7	338	186	7.85	378	45	9.17	139	47	10.57	86	49
U_R = 50V (Voltage code 5)														
MP025#R05-B--	0.05	N/A	20.9	856	471	0.06	881	1411	0.06	562	1216	0.06	498	983
MP025#0R1-B--	0.1	6000	19.4	848	466	0.11	873	1316	0.11	554	1115	0.11	490	914
MP025#R15-B--	0.15	4800	17.9	840	462	0.16	866	1222	0.16	547	1013	0.16	482	845
MP025#0R2-B--	0.2	3600	16.4	832	457	0.21	858	1128	0.21	539	912	0.22	474	776
MP025#R25-B--	0.25	2700	15.5	823	453	0.26	850	1033	0.27	523	810	0.27	465	707
MP025#0R3-B--	0.3	1800	14.6	815	448	0.31	842	939	0.32	525	708	0.32	457	638

"#"-can be either "J" or "K" temperature coefficient

0402 Typical Electrical Tables

Part Number	Capacitance (pF)	ESR Max. mOhm	SRF GHz	Q Standard Value @ 1GHz		Frequency 900MHz			Frequency 1900MHz			Frequency 2400MHz		
				Typ.	Min.	Ceff (pF)	Q Typ.	ESR Typ. (mOhm)	Ceff (pF)	Q Typ.	ESR Typ. (mOhm)	Ceff (pF)	Q Typ.	ESR Typ. (mOhm)
MP025#R35-B--	0.35	1650	14.1	807	444	0.36	834	844	0.37	517	607	0.37	449	569
MP025#OR4-B--	0.4	1500	125.0	799	439	0.41	827	750	0.42	510	505	0.42	441	500
MP025#R45-B--	0.45	1400	11.9	791	435	0.46	819	667	0.47	502	458	0.48	432	453
MP025#OR5-B--	0.5	1300	11.3	783	430	0.51	811	583	0.52	495	410	0.53	424	407
MP025#R55-B--	0.55	1200	10.9	774	426	0.57	803	500	0.57	487	363	0.58	416	360
MP025#OR6-B--	0.6	1100	10.4	766	421	0.62	796	465	0.62	480	343	0.63	408	339
MP025#R65-B--	0.65	1025	10.0	758	417	0.67	788	431	0.67	472	322	0.68	399	317
MP025#OR7-B--	0.7	950	9.5	750	413	0.72	780	396	0.72	465	302	0.73	391	296
MP025#R75-B--	0.75	900	9.3	746	410	0.77	776	375	0.78	456	290	0.79	381	285
MP025#OR8-B--	0.8	850	9.1	743	408	0.82	772	354	0.83	447	277	0.84	370	273
MP025#R85-B--	0.85	800	9.0	739	406	0.87	768	334	0.88	438	265	0.89	360	262
MP025#OR9-B--	0.9	750	8.8	735	404	0.92	764	313	0.93	429	253	0.95	350	250
MP025#R95-B--	0.95	712	8.4	732	402	0.97	760	292	0.98	420	240	1.00	339	239
MP025#1R0-B--	1	675	8.0	728	400	1.02	756	271	1.04	411	228	1.05	329	227
Contact Factory	1.05	638	7.9	725	398	1.07	752	258	1.09	406	221	1.11	323	221
MP025#1R1-B--	1.1	600	7.8	721	397	1.12	749	245	1.14	401	214	1.16	318	214
Contact Factory	1.15	575	7.6	718	395	1.17	745	232	1.20	396	207	1.22	312	208
MP025#1R2-B--	1.2	550	7.4	714	393	1.22	742	218	1.25	391	200	1.27	306	202
Contact Factory	1.25	525	7.2	711	391	1.27	738	205	1.31	386	193	1.32	301	195
MP025#1R3-B--	1.3	500	7.0	707	389	1.32	734	192	1.36	381	185	1.38	295	189
Contact Factory	1.35	485	6.9	704	387	1.37	731	179	1.41	376	178	1.43	289	183
MP025#1R4-B--	1.4	470	6.8	700	385	1.42	727	165	1.47	371	171	1.49	283	177
Contact Factory	1.45	460	6.7	697	383	1.47	724	152	1.52	366	164	1.54	278	170
MP025#1R5-B--	1.5	450	6.5	693	381	1.52	720	139	1.58	361	157	1.60	272	164
Contact Factory	1.55	440	6.5	690	379	1.56	716	135	1.62	358	153	1.65	269	159
MP025#1R6-B--	1.6	430	6.5	686	377	1.61	716	130	1.67	355	148	1.70	267	155
Contact Factory	1.65	422	6.5	683	375	1.66	709	126	1.72	352	143	1.76	264	150
MP025#1R7-B--	1.7	415	6.4	679	373	1.71	705	122	1.77	349	139	1.81	267	146
Contact Factory	1.75	408	6.3	676	372	1.75	702	118	1.82	347	134	1.86	259	141
MP025#1R8-B--	1.8	400	6.2	672	370	1.80	698	113	1.87	344	130	1.92	256	137

"#"-can be either "J" or "K" temperature coefficient

0603 Typical Electrical Tables

Part Number	Capacitance (pF)	ESR Max. mOhm	SRF GHz	Q Standard Value @ 1GHz		Frequency 900MHz			Frequency 1900MHz			Frequency 2400MHz		
				Typ.	Min.	Ceff (pF)	Q Typ.	ESR Typ. (mOhm)	Ceff (pF)	Q Typ.	ESR Typ. (mOhm)	Ceff (pF)	Q Typ.	ESR Typ. (mOhm)
U_R = 10V (Voltage code Z)														
MP03Z#R05-B--	0.05	N/A	25.6	1200	660	0.06	1333	945	0.06	556	832	0.06	397	880
MP03Z#R01-B--	0.1	6000	18.1	1156	636	0.11	1284	675	0.11	535	628	0.11	382	667
MP03Z#R15-B--	0.15	4800	14.8	1111	611	0.16	1235	555	0.16	514	533	0.16	367	567
MP03Z#R2-B--	0.2	3600	12.8	1067	587	0.21	1185	483	0.21	494	474	0.22	353	505
MP03Z#R25-B--	0.25	2700	11.4	1022	562	0.26	1136	433	0.27	473	433	0.27	338	462
MP03Z#R03-B--	0.3	1800	10.4	978	538	0.31	1086	397	0.32	453	402	0.32	323	430
MP03Z#R35-B--	0.35	1650	9.7	933	513	0.36	1037	368	0.37	432	378	0.37	309	404
MP03Z#R04-B--	0.4	1500	9.0	889	489	0.41	988	345	0.42	412	358	0.42	294	383
MP03Z#R45-B--	0.45	1400	8.5	844	464	0.46	938	326	0.47	391	341	0.48	279	365
MP03Z#R05-B--	0.5	1300	8.1	800	440	0.51	889	310	0.52	370	327	0.53	265	350
MP03Z#R55-B--	0.55	1200	7.7	788	434	0.57	875	296	0.57	363	315	0.58	261	337
MP03Z#R06-B--	0.6	1100	7.4	777	427	0.62	860	283	0.62	356	304	0.63	258	326
MP03Z#R65-B--	0.65	1025	7.1	765	421	0.67	846	273	0.67	348	294	0.68	255	315
MP03Z#R07-B--	0.7	950	6.8	754	414	0.72	832	263	0.72	341	285	0.73	252	306
MP03Z#R75-B--	0.75	900	6.6	742	408	0.77	817	254	0.78	334	277	0.79	248	298
MP03Z#R08-B--	0.8	800	6.4	730	402	0.82	803	247	0.83	326	270	0.84	245	290
MP03Z#R85-B--	0.85	750	6.2	719	395	0.87	789	239	0.88	319	264	0.89	242	283
MP03Z#R09-B--	0.9	700	6.0	707	389	0.92	775	233	0.93	312	258	0.95	239	277
MP03Z#R95-B--	0.95	650	5.9	696	383	0.97	760	227	0.98	304	252	1.00	235	271
MP03Z#1R0-B--	1	600	5.7	684	376	1.019	746	216	1.061	297	242	1.101	232	260
Contact Factory	1.05	575	5.6	667	367	1.076	731	213	1.126	290	239	1.171	226	256
MP03Z#1R1-B--	1.1	550	5.4	649	357	1.134	717	210	1.190	282	236	1.241	220	253
Contact Factory	1.15	525	5.3	632	347	1.192	702	206	1.254	275	233	1.311	214	250
MP03Z#1R2-B--	1.2	500	5.2	614	338	1.250	687	203	1.318	267	230	1.381	209	247
Contact Factory	1.25	475	5.1	605	333	1.307	677	200	1.382	262	227	1.451	203	244
MP03Z#1R3-B--	1.3	450	5.0	596	328	1.365	667	197	1.446	257	224	1.521	197	241
Contact Factory	1.35	435	4.9	587	323	1.423	658	194	1.511	252	221	1.591	191	238
MP03Z#1R4-B--	1.4	420	4.8	578	318	1.481	648	190	1.575	247	218	1.661	185	235
Contact Factory	1.45	405	4.8	569	313	1.538	638	187	1.639	242	215	1.731	179	232
MP03Z#1R5-B--	1.5	390	4.7	560	308	1.596	628	184	1.703	237	212	1.801	173	229
Contact Factory	1.55	380	4.6	551	303	1.645	620	181	1.760	233	209	1.866	170	226
MP03Z#1R6-B--	1.6	370	4.5	542	298	1.694	611	178	1.817	228	206	1.930	166	222
Contact Factory	1.65	360	4.5	534	293	1.743	603	175	1.874	224	203	1.995	163	219
MP03Z#1R7-B--	1.7	350	4.4	525	289	1.792	595	172	1.931	219	200	2.060	159	216
Contact Factory	1.75	340	4.3	516	284	1.841	587	169	1.988	215	197	2.124	156	213
MP03Z#1R8-B--	1.8	330	4.2	507	279	1.890	578	166	2.045	211	194	2.189	153	209
Contact Factory	1.85	320	4.2	498	274	1.939	570	163	2.102	206	191	2.253	149	206
MP03Z#1R9-B--	1.9	310	4.1	490	269	1.988	562	160	2.158	202	188	2.318	146	203
Contact Factory	1.95	300	4.1	481	264	2.037	553	157	2.215	197	185	2.383	142	199
MP03Z#2R0-B--	2	290	4.0	472	260	2.086	545	154	2.272	193	182	2.447	139	196
MP03Z#2R1-B--	2.1	285	3.9	462	254	2.190	535	151	2.402	187	180	2.604	134	193
MP03Z#2R2-B--	2.2	280	3.8	452	249	2.295	524	148	2.532	181	177	2.761	129	191
MP03Z#2R3-B--	2.3	275	3.8	442	243	2.400	514	145	2.662	175	175	2.917	124	188
MP03Z#2R4-B--	2.4	270	3.7	433	238	2.504	503	143	2.793	168	172	3.074	118	186
MP03Z#2R5-B--	2.5	265	3.6	423	232	2.609	493	140	2.923	162	170	3.230	113	183
MP03Z#2R6-B--	2.6	265	3.6	413	227	2.714	482	137	3.053	156	167	3.387	108	181
MP03Z#2R7-B--	2.7	260	3.5	403	222	2.818	472	134	3.183	150	165	3.543	103	178
MP03Z#2R8-B--	2.8	255	3.4	395	217	3.933	463	133	3.336	147	164	3.742	100	177
MP03Z#2R9-B--	2.9	255	3.4	388	213	3.047	453	131	3.489	144	162	3.940	97	175
MP03Z#3R0-B--	3	250	3.3	380	209	3.162	444	130	3.642	140	161	4.139	95	174
MP03Z#3R1-B--	3.1	245	3.2	372	205	3.276	435	129	3.795	137	160	4.337	92	172
MP03Z#3R2-B--	3.2	245	3.2	365	201	3.391	425	127	3.947	134	159	4.536	89	171
MP03Z#3R3-B--	3.3	250	3.1	357	196	3.506	416	126	4.100	131	157	4.734	86	169
MP03Z#3R4-B--	3.4	235	3.1	349	192	3.620	407	125	4.253	128	156	4.933	84	168
MP03Z#3R5-B--	3.5	235	3.1	342	188	3.735	397	123	4.406	125	155	5.131	81	166
MP03Z#3R6-B--	3.6	230	3.0	334	184	3.849	388	122	4.559	121	154	5.330	78	165
MP03Z#3R7-B--	3.7	225	3.0	326	179	3.964	379	121	4.712	118	152	5.528	75	164
MP03Z#3R8-B--	3.8	225	3.0	318	175	4.078	369	119	4.865	115	151	5.727	73	162
MP03Z#3R9-B--	3.9	220	2.9	311	171	4.193	360	118	5.019	112	150	5.925	70	161
MP03Z#4R0-B--	4	215	2.9	307	169	4.301	355	117	5.188	110	149	6.188	68	160
MP03Z#4R1-B--	4.1	215	2.8	303	167	4.410	351	116	5.358	108	148	6.450	67	159
MP03Z#4R2-B--	4.2	210	2.8	299	164	4.518	347	116	5.528	106	148	6.713	65	158
MP03Z#4R3-B--	4.3	210	2.7	295	162	4.627	342	115	5.698	104	147	6.975	64	157
MP03Z#4R4-B--	4.4	205	2.7	291	160	4.735	338	114	5.867	102	146	7.238	62	157

"#"-can be either "J" or "K" temperature coefficient

Accu-P[®] MP Medical Grade



0603 Typical Electrical Tables

Part Number	Capacitance (pF)	ESR Max. mOhm	SRF GHz	Q Standard Value @ 1GHz		Frequency 900MHz			Frequency 1900MHz			Frequency 2400MHz		
				Typ.	Min.	Ceff (pF)	Q Typ.	ESR Typ. (mOhm)	Ceff (pF)	Q Typ.	ESR Typ. (mOhm)	Ceff (pF)	Q Typ.	ESR Typ. (mOhm)
MP03Z#4R5-B--	4.5	205	2.7	287	158	4.843	333	113	6.037	100	146	7.500	61	156
MP03Z#4R6-B--	4.6	200	2.6	283	156	4.952	329	112	6.207	98	145	7.763	59	155
MP03Z#4R7-B--	4.7	200	2.6	279	154	5.060	324	112	6.377	96	144	8.025	58	154
MP03Z#5R1-B--	5.1	195	2.5	263	145	5.494	307	109	7.057	88	142	9.075	52	151
MP03Z#5R6-B--	5.6	190	2.4	244	134	6.035	285	105	7.906	78	138	10.39	44	147
MP03Z#6R2-B--	6.2	185	2.3	228	126	6.865	267	102	9.517	72	133	13.66	40	141
MP03Z#6R8-B--	6.8	180	2.2	213	117	7.694	250	100	11.13	66	128	16.93	35	135
MP03Z#7R5-B--	7.5	175	2.1	195	107	8.367	227	98	12.63	57	125	20.91	28	132
MP03Z#8R2-B--	8.2	170	2.0	176	97	9.041	205	96	14.14	49	123	24.88	21	129
MP03Z#9R1-B--	9.1	165	1.9	161	89	10.20	188	96	18.09	42	122	40.00	16	128
MP03Z#100-B--	10	160	1.8	146	80	11.37	171	95	22.05	36	121	70.00	12	127
MP03Z#110-B--	11	155	1.7	129	71	12.66	153	95	26.44	29	120	140.0	6	126
MP03Z#120-B--	12	155	1.6	112	62	13.95	134	94	30.83	22	119	231.3	1	125
MP03Z#130-B--	13	150	1.6	102	56	15.31	122	93	40.37	18	118	N/A	N/A	N/A
MP03Z#140-B--	14	150	1.5	92	51	16.67	111	92	49.91	15	118	N/A	N/A	N/A
MP03Z#150-B--	15	145	1.5	82	45	18.03	99	90	59.44	11	117	N/A	N/A	N/A
MP03Z#160-B--	16	145	1.4	79	43	19.61	96	90	80.00	8	117	N/A	N/A	N/A
MP03Z#170-B--	17	140	1.4	76	42	21.18	92	90	120.0	6	116	N/A	N/A	N/A
MP03Z#180-B--	18	140	1.3	73	40	22.76	89	90	190.0	4	116	N/A	N/A	N/A
MP03Z#190-B--	19	140	1.3	69	38	24.37	84	89	N/A	N/A	N/A	N/A	N/A	N/A
MP03Z#200-B--	20	135	1.2	65	36	25.98	80	89	N/A	N/A	N/A	N/A	N/A	N/A
MP03Z#220-B--	22	135	1.2	57	31	29.21	72	87	N/A	N/A	N/A	N/A	N/A	N/A
MP03Z#240-B--	24	135	1.2	48	26	34.44	62	87	N/A	N/A	N/A	N/A	N/A	N/A
MP03ZK270-B--	27	130	1.1	43	24	41.87	56	86	N/A	N/A	N/A	N/A	N/A	N/A
MP03ZK300-B--	30	130	1.0	37	21	49.29	49	85	N/A	N/A	N/A	N/A	N/A	N/A
MP03ZK330-B--	33	130	1.0	32	18	56.72	43	84	N/A	N/A	N/A	N/A	N/A	N/A
MP03ZK390-B--	39	120	1.0	21	12	71.57	30	82	N/A	N/A	N/A	N/A	N/A	N/A
MP03ZK470-B--	47	120	1.0	15	10	92.31	10	79	N/A	N/A	N/A	N/A	N/A	N/A
Ur = 16V (Voltage code Y)														
MP03Y#R05-B--	0.05	N/A	25.6	1200	660	0.06	1333	945	0.06	556	832	0.06	397	880
MP03Y#R1-B--	0.1	6000	18.1	1156	636	0.11	1284	675	0.11	535	628	0.11	382	667
MP03Y#R15-B--	0.15	4800	14.8	1111	611	0.16	1235	555	0.16	514	533	0.16	367	567
MP03Y#R2-B--	0.2	3600	12.8	1067	587	0.21	1185	483	0.21	494	474	0.22	353	505
MP03Y#R25-B--	0.25	2700	11.4	1022	562	0.26	1136	433	0.27	473	433	0.27	338	462
MP03Y#R3-B--	0.3	1800	10.4	978	538	0.31	1086	397	0.32	453	402	0.32	323	430
MP03Y#R35-B--	0.35	1650	9.7	933	513	0.36	1037	368	0.37	432	378	0.37	309	404
MP03Y#R4-B--	0.4	1500	9.0	889	489	0.41	988	345	0.42	412	358	0.42	294	383
MP03Y#R45-B--	0.45	1400	8.5	844	464	0.46	938	326	0.47	391	341	0.48	279	365
MP03Y#R5-B--	0.5	1300	8.1	800	440	0.51	889	310	0.52	370	327	0.53	265	350
MP03Y#R55-B--	0.55	1200	7.7	788	434	0.57	875	296	0.57	363	315	0.58	261	337
MP03Y#R6-B--	0.6	1100	7.4	777	427	0.62	860	283	0.62	356	304	0.63	258	326
MP03Y#R65-B--	0.65	1025	7.1	765	421	0.67	846	273	0.67	348	294	0.68	255	315
MP03Y#R7-B--	0.7	950	6.8	754	414	0.72	832	263	0.72	341	285	0.73	252	306
MP03Y#R75-B--	0.75	900	6.6	742	408	0.77	817	254	0.78	334	277	0.79	248	298
MP03Y#R8-B--	0.8	800	6.4	730	402	0.82	803	247	0.83	326	270	0.84	245	290
MP03Y#R85-B--	0.85	750	6.2	719	395	0.87	789	239	0.88	319	264	0.89	242	283
MP03Y#R9-B--	0.9	700	6.0	707	389	0.92	775	233	0.93	312	258	0.95	239	277
MP03Y#R95-B--	0.95	650	5.9	696	383	0.97	760	227	0.98	304	252	1.00	235	271
MP03Y#R10-B--	1	600	5.7	684	376	1.019	746	216	1.061	297	242	1.101	232	260
Contact Factory	1.05	575	5.6	667	367	1.076	731	213	1.126	290	239	1.171	226	256
MP03Y#R11-B--	1.1	550	5.4	649	357	1.134	717	210	1.190	282	236	1.241	220	253
Contact Factory	1.15	525	5.3	632	347	1.192	702	206	1.254	275	233	1.311	214	250
MP03Y#R12-B--	1.2	500	5.2	614	338	1.250	687	203	1.318	267	230	1.381	209	247
Contact Factory	1.25	475	5.1	605	333	1.307	677	200	1.382	262	227	1.451	203	244
Ur = 16V (Voltage code Y)														
MP03Y#R13-B--	1.3	450	5.0	596	328	1.365	667	197	1.446	257	224	1.521	197	241
Contact Factory	1.35	435	4.9	587	323	1.423	658	194	1.511	252	221	1.591	191	238
MP03Y#R14-B--	1.4	420	4.8	578	318	1.481	648	190	1.575	247	218	1.661	185	235
Contact Factory	1.45	405	4.8	569	313	1.538	638	187	1.639	242	215	1.731	179	232
MP03Y#R15-B--	1.5	390	4.7	560	308	1.596	628	184	1.703	237	212	1.801	173	229
Contact Factory	1.55	380	4.6	551	303	1.645	620	181	1.760	233	209	1.866	170	226
MP03Y#R16-B--	1.6	370	4.5	542	298	1.694	611	178	1.817	228	206	1.930	166	222
Contact Factory	1.65	360	4.5	534	293	1.743	603	175	1.874	224	203	1.995	163	219
MP03Y#R17-B--	1.7	350	4.4	525	289	1.792	595	172	1.931	219	200	2.060	159	216
Contact Factory	1.75	340	4.3	516	284	1.841	587	169	1.988	215	197	2.124	156	213

"#"-can be either "J" or "K" temperature coefficient



0603 Typical Electrical Tables

Part Number	Capacitance (pF)	ESR Max. mOhm	SRF GHz	Q Standard Value @ 1GHz		Frequency 900MHz			Frequency 1900MHz			Frequency 2400MHz		
				Typ.	Min.	Ceff (pF)	Q Typ.	ESR Typ. (mOhm)	Ceff (pF)	Q Typ.	ESR Typ. (mOhm)	Ceff (pF)	Q Typ.	ESR Typ. (mOhm)
MP03Y#1R8-B--	1.8	330	4.2	507	279	1.890	578	166	2.045	211	194	2.189	153	209
Contact Factory	1.85	320	4.2	498	274	1.939	570	163	2.102	206	191	2.253	149	206
MP03Y#1R9-B--	1.9	310	4.1	490	269	1.988	562	160	2.158	202	188	2.318	146	203
Contact Factory	1.95	300	4.1	481	264	2.037	553	157	2.215	197	185	2.383	142	199
MP03Y#2R0-B--	2	290	4.0	472	260	2.086	545	154	2.272	193	182	2.447	139	196
MP03Y#2R1-B--	2.1	285	3.9	462	254	2.190	535	151	2.402	187	180	2.604	134	193
MP03Y#2R2-B--	2.2	280	3.8	452	249	2.295	524	148	2.532	181	177	2.761	129	191
MP03Y#2R3-B--	2.3	275	3.8	442	243	2.400	514	145	2.662	175	175	2.917	124	188
MP03Y#2R4-B--	2.4	270	3.7	433	238	2.504	503	143	2.793	168	172	3.074	118	186
MP03Y#2R5-B--	2.5	265	3.6	423	232	2.609	493	140	2.923	162	170	3.230	113	183
MP03Y#2R6-B--	2.6	265	3.6	413	227	2.714	482	137	3.053	156	167	3.387	108	181
MP03Y#2R7-B--	2.7	260	3.5	403	222	2.818	472	134	3.183	150	165	3.543	103	178
MP03Y#2R8-B--	2.8	255	3.4	395	217	3.933	463	133	3.336	147	164	3.742	100	177
MP03Y#2R9-B--	2.9	255	3.4	388	213	3.047	453	131	3.489	144	162	3.940	97	175
MP03Y#3R0-B--	3	250	3.3	380	209	3.162	444	130	3.642	140	161	4.139	95	174
MP03Y#3R1-B--	3.1	245	3.2	372	205	3.276	435	129	3.795	137	160	4.337	92	172
MP03Y#3R2-B--	3.2	245	3.2	365	201	3.391	425	127	3.947	134	159	4.536	89	171
MP03Y#3R3-B--	3.3	250	3.1	357	196	3.506	416	126	4.100	131	157	4.734	86	169
MP03Y#3R4-B--	3.4	235	3.1	349	192	3.620	407	125	4.253	128	156	4.933	84	168
MP03Y#3R5-B--	3.5	235	3.1	342	188	3.735	397	123	4.406	125	155	5.131	81	166
MP03Y#3R6-B--	3.6	230	3.0	334	184	3.849	388	122	4.559	121	154	5.330	78	165
MP03Y#3R7-B--	3.7	225	3.0	326	179	3.964	379	121	4.712	118	152	5.528	75	164
MP03Y#3R8-B--	3.8	225	3.0	318	175	4.078	369	119	4.865	115	151	5.727	73	162
MP03Y#3R9-B--	3.9	220	2.9	311	171	4.193	360	118	5.019	112	150	5.925	70	161
MP03Y#4R0-B--	4	215	2.9	307	169	4.301	355	117	5.188	110	149	6.188	68	160
MP03Y#4R1-B--	4.1	215	2.8	303	167	4.410	351	116	5.358	108	148	6.450	67	159
MP03Y#4R2-B--	4.2	210	2.8	299	164	4.518	347	116	5.528	106	148	6.713	65	158
MP03Y#4R3-B--	4.3	210	2.7	295	162	4.627	342	115	5.698	104	147	6.975	64	157
MP03Y#4R4-B--	4.4	205	2.7	291	160	4.735	338	114	5.867	102	146	7.238	62	157
MP03Y#4R5-B--	4.5	205	2.7	287	158	4.843	333	113	6.037	100	146	7.500	61	156
MP03Y#4R6-B--	4.6	200	2.6	283	156	4.952	329	112	6.207	98	145	7.763	59	155
MP03Y#4R7-B--	4.7	200	2.6	279	154	5.060	324	112	6.377	96	144	8.025	58	154
MP03Y#5R1-B--	5.1	195	2.5	263	145	5.494	307	109	7.057	88	142	9.075	52	151
MP03Y#5R6-B--	5.6	190	2.4	244	134	6.035	285	105	7.906	78	138	10.390	44	147
MP03Y#6R2-B--	6.2	185	2.3	228	126	6.865	267	102	9.517	72	133	13.660	40	141
MP03Y#6R8-B--	6.8	180	2.2	213	117	7.694	250	100	11.130	66	128	16.930	35	135
MP03Y#7R5-B--	7.5	175	2.1	195	107	8.367	227	98	12.630	57	125	20.910	28	132
MP03Y#8R2-B--	8.2	170	2.0	176	97	9.041	205	96	14.140	49	123	24.880	21	129
MP03Y#9R1-B--	9.1	165	1.9	161	89	10.20	188	96	18.09	42	122	40.00	16	128
MP03Y#100-B--	10	160	1.8	146	80	11.37	171	95	22.05	36	121	70.00	12	127
MP03Y#110-B--	11	155	1.7	129	71	12.66	153	95	26.44	29	120	140.0	6	126
MP03Y#120-B--	12	155	1.6	112	62	13.95	134	94	30.83	22	119	231.3	1	125
MP03Y#130-B--	13	150	1.6	102	56	15.31	122	93	40.37	18	118	N/A	N/A	N/A
MP03Y#140-B--	14	150	1.5	92	51	16.67	111	92	49.91	15	118	N/A	N/A	N/A
MP03Y#150-B--	15	145	1.5	82	45	18.03	99	90	59.44	11	117	N/A	N/A	N/A
MP03Y#160-B--	16	145	1.4	79	43	19.61	96	90	80.00	8	117	N/A	N/A	N/A
MP03Y#170-B--	17	140	1.4	76	42	21.18	92	90	120.0	6	116	N/A	N/A	N/A
MP03Y#180-B--	18	140	1.3	73	40	22.76	89	90	190.0	4	116	N/A	N/A	N/A
MP03Y#190-B--	19	140	1.3	69	38	24.37	84	89	N/A	N/A	N/A	N/A	N/A	N/A
U_R = 16V (Voltage code Y)														
MP03Y#200-B--	20	135	1.2	65	36	25.98	80	89	N/A	N/A	N/A	N/A	N/A	N/A
MP03Y#220-B--	22	135	1.2	57	31	29.21	72	87	N/A	N/A	N/A	N/A	N/A	N/A
MP03Y#240-B--	24	135	1.2	48	26	34.44	62	87	N/A	N/A	N/A	N/A	N/A	N/A
MP03YK270-B--	27	130	1.1	43	24	41.87	56	86	N/A	N/A	N/A	N/A	N/A	N/A
MP03YK300-B--	30	130	1.0	37	21	49.29	49	85	N/A	N/A	N/A	N/A	N/A	N/A
MP03YK330-B--	33	130	1.0	32	18	56.72	43	84	N/A	N/A	N/A	N/A	N/A	N/A
MP03YK390-B--	39	120	1.0	21	12	71.57	30	82	N/A	N/A	N/A	N/A	N/A	N/A
U_R = 25V (Voltage code 3)														
MP033#R05-B--	0.05	N/A	25.6	1200	660	0.06	1333	945	0.06	556	832	0.06	397	880
MP033#R1-B--	0.1	6000	18.1	1156	636	0.11	1284	675	0.11	535	628	0.11	382	667
MP033#R15-B--	0.15	4800	14.8	1111	611	0.16	1235	555	0.16	514	533	0.16	367	567
MP033#R2-B--	0.2	3600	12.8	1067	587	0.21	1185	483	0.21	494	474	0.22	353	505
MP033#R25-B--	0.25	2700	11.4	1022	562	0.26	1136	433	0.27	473	433	0.27	338	462
MP033#R3-B--	0.3	1800	10.4	978	538	0.31	1086	397	0.32	453	402	0.32	323	430
MP033#R35-B--	0.35	1650	9.7	933	513	0.36	1037	368	0.37	432	378	0.37	309	404

"#"-can be either "J" or "K" temperature coefficient

Accu-P® MP Medical Grade

0603 Typical Electrical Tables



Part Number	Capacitance (pF)	ESR Max. mOhm	SRF GHz	Q Standard Value @ 1GHz		Frequency 900MHz			Frequency 1900MHz			Frequency 2400MHz		
				Typ.	Min.	Ceff (pF)	Q Typ.	ESR Typ. (mOhm)	Ceff (pF)	Q Typ.	ESR Typ. (mOhm)	Ceff (pF)	Q Typ.	ESR Typ. (mOhm)
MP033#0R4-B--	0.4	1500	9.0	889	489	0.41	988	345	0.42	412	358	0.42	294	383
MP033#R45-B--	0.45	1400	8.5	844	464	0.46	938	326	0.47	391	341	0.48	279	365
MP033#0R5-B--	0.5	1300	8.1	800	440	0.51	889	310	0.52	370	327	0.53	265	350
MP033#R55-B--	0.55	1200	7.7	788	434	0.57	875	296	0.57	363	315	0.58	261	337
MP033#0R6-B--	0.6	1100	7.4	777	427	0.62	860	283	0.62	356	304	0.63	258	326
MP033#R65-B--	0.65	1025	7.1	765	421	0.67	846	273	0.67	348	294	0.68	255	315
MP033#0R7-B--	0.7	950	6.8	754	414	0.72	832	263	0.72	341	285	0.73	252	306
MP033#R75-B--	0.75	900	6.6	742	408	0.77	817	254	0.78	334	277	0.79	248	298
MP033#0R8-B--	0.8	800	6.4	730	402	0.82	803	247	0.83	326	270	0.84	245	290
MP033#R85-B--	0.85	750	6.2	719	395	0.87	789	239	0.88	319	264	0.89	242	283
MP033#0R9-B--	0.9	700	6.0	707	389	0.92	775	233	0.93	312	258	0.95	239	277
MP033#R95-B--	0.95	650	5.9	696	383	0.97	760	227	0.98	304	252	1.00	235	271
MP033#1R0-B--	1	600	5.7	684	376	1.019	746	216	1.061	297	242	1.101	232	260
Contact Factory	1.05	575	5.6	667	367	1.076	731	213	1.126	290	239	1.171	226	256
MP033#1R1-B--	1.1	550	5.4	649	357	1.134	717	210	1.190	282	236	1.241	220	253
Contact Factory	1.15	525	5.3	632	347	1.192	702	206	1.254	275	233	1.311	214	250
MP033#1R2-B--	1.2	500	5.2	614	338	1.250	687	203	1.318	267	230	1.381	209	247
Contact Factory	1.25	475	5.1	605	333	1.307	677	200	1.382	262	227	1.451	203	244
MP033#1R3-B--	1.3	450	5.0	596	328	1.365	667	197	1.446	257	224	1.521	197	241
Contact Factory	1.35	435	4.9	587	323	1.423	658	194	1.511	252	221	1.591	191	238
MP033#1R4-B--	1.4	420	4.8	578	318	1.481	648	190	1.575	247	218	1.661	185	235
Contact Factory	1.45	405	4.8	569	313	1.538	638	187	1.639	242	215	1.731	179	232
MP033#1R5-B--	1.5	390	4.7	560	308	1.596	628	184	1.703	237	212	1.801	173	229
Contact Factory	1.55	380	4.6	551	303	1.645	620	181	1.760	233	209	1.866	170	226
MP033#1R6-B--	1.6	370	4.5	542	298	1.694	611	178	1.817	228	206	1.930	166	222
Contact Factory	1.65	360	4.5	534	293	1.743	603	175	1.874	224	203	1.995	163	219
MP033#1R7-B--	1.7	350	4.4	525	289	1.792	595	172	1.931	219	200	2.060	159	216
Contact Factory	1.75	340	4.3	516	284	1.841	587	169	1.988	215	197	2.124	156	213
MP033#1R8-B--	1.8	330	4.2	507	279	1.890	578	166	2.045	211	194	2.189	153	209
Contact Factory	1.85	320	4.2	498	274	1.939	570	163	2.102	206	191	2.253	149	206
MP033#1R9-B--	1.9	310	4.1	490	269	1.988	562	160	2.158	202	188	2.318	146	203
Contact Factory	1.95	300	4.1	481	264	2.037	553	157	2.215	197	185	2.383	142	199
MP033#2R0-B--	2	290	4.0	472	260	2.086	545	154	2.272	193	182	2.447	139	196
MP033#2R1-B--	2.1	285	3.9	462	254	2.190	535	151	2.402	187	180	2.604	134	193
MP033#2R2-B--	2.2	280	3.8	452	249	2.295	524	148	2.532	181	177	2.761	129	191
MP033#2R3-B--	2.3	275	3.8	442	243	2.400	514	145	2.662	175	175	2.917	124	188
MP033#2R4-B--	2.4	270	3.7	433	238	2.504	503	143	2.793	168	172	3.074	118	186
MP033#2R5-B--	2.5	265	3.6	423	232	2.609	493	140	2.923	162	170	3.230	113	183
MP033#2R6-B--	2.6	265	3.6	413	227	2.714	482	137	3.053	156	167	3.387	108	181
MP033#2R7-B--	2.7	260	3.5	403	222	2.818	472	134	3.183	150	165	3.543	103	178
MP033#2R8-B--	2.8	255	3.4	395	217	3.933	463	133	3.336	147	164	3.742	100	177
MP033#2R9-B--	2.9	255	3.4	388	213	3.047	453	131	3.489	144	162	3.940	97	175
MP033#3R0-B--	3	250	3.3	380	209	3.162	444	130	3.642	140	161	4.139	95	174
MP033#3R1-B--	3.1	245	3.2	372	205	3.276	435	129	3.795	137	160	4.337	92	172
UR = 25V (Voltage code 3)														
MP033#3R2-B--	3.2	245	3.2	365	201	3.391	425	127	3.947	134	159	4.536	89	171
MP033#3R3-B--	3.3	250	3.1	357	196	3.506	416	126	4.100	131	157	4.734	86	169
MP033#3R4-B--	3.4	235	3.1	349	192	3.620	407	125	4.253	128	156	4.933	84	168
MP033#3R5-B--	3.5	235	3.1	342	188	3.735	397	123	4.406	125	155	5.131	81	166
MP033#3R6-B--	3.6	230	3.0	334	184	3.849	388	122	4.559	121	154	5.330	78	165
MP033#3R7-B--	3.7	225	3.0	326	179	3.964	379	121	4.712	118	152	5.528	75	164
MP033#3R8-B--	3.8	225	3.0	318	175	4.078	369	119	4.865	115	151	5.727	73	162
MP033#3R9-B--	3.9	220	2.9	311	171	4.193	360	118	5.019	112	150	5.925	70	161
MP033#4R0-B--	4	215	2.9	307	169	4.301	355	117	5.188	110	149	6.188	68	160
MP033#4R1-B--	4.1	215	2.8	303	167	4.410	351	116	5.358	108	148	6.450	67	159
MP033#4R2-B--	4.2	210	2.8	299	164	4.518	347	116	5.528	106	148	6.713	65	158
MP033#4R3-B--	4.3	210	2.7	295	162	4.627	342	115	5.698	104	147	6.975	64	157
MP033#4R4-B--	4.4	205	2.7	291	160	4.735	338	114	5.867	102	146	7.238	62	157
MP033#4R5-B--	4.5	205	2.7	287	158	4.843	333	113	6.037	100	146	7.500	61	156
MP033#4R6-B--	4.6	200	2.6	283	156	4.952	329	112	6.207	98	145	7.763	59	155
MP033#4R7-B--	4.7	200	2.6	279	154	5.060	324	112	6.377	96	144	8.025	58	154
MP033#5R1-B--	5.1	195	2.5	263	145	5.494	307	109	7.057	88	142	9.075	52	151
MP033#5R6-B--	5.6	190	2.4	244	134	6.035	285	105	7.906	78	138	10.390	44	147
MP033#6R2-B--	6.2	185	2.3	228	126	6.865	267	102	9.517	72	133	13.660	40	141
MP033#6R8-B--	6.8	180	2.2	213	117	7.694	250	100	11.130	66	128	16.930	35	135

"#"-can be either "J" or "K" temperature coefficient



0603 Typical Electrical Tables

Part Number	Capacitance (pF)	ESR Max. mOhm	SRF GHz	Q Standard Value @ 1GHz		Frequency 900MHz			Frequency 1900MHz			Frequency 2400MHz		
				Typ.	Min.	Ceff (pF)	Q Typ.	ESR Typ. (mOhm)	Ceff (pF)	Q Typ.	ESR Typ. (mOhm)	Ceff (pF)	Q Typ.	ESR Typ. (mOhm)
MP033#7R5-B--	7.5	175	2.1	195	107	8.367	227	98	12.630	57	125	20.910	28	132
MP033#8R2-B--	8.2	170	2.0	176	97	9.041	205	96	14.140	49	123	24.880	21	129
MP033#9R1-B--	9.1	165	1.9	161	89	10.20	188	96	18.09	42	122	40.00	16	128
MP033#100-B--	10	160	1.8	146	80	11.37	171	95	22.05	36	121	70.00	12	127
MP033#110-B--	11	155	1.7	129	71	12.66	153	95	26.44	29	120	140.0	6	126
MP033#120-B--	12	155	1.6	112	62	13.95	134	94	30.83	22	119	231.3	1	125
MP033#130-B--	13	150	1.6	102	56	15.31	122	93	40.37	18	118	N/A	N/A	N/A
MP033#140-B--	14	150	1.5	92	51	16.67	111	92	49.91	15	118	N/A	N/A	N/A
MP033#150-B--	15	145	1.5	82	45	18.03	99	90	59.44	11	117	N/A	N/A	N/A
MP033#160-B--	16	145	1.4	79	43	19.61	96	90	80.00	8	117	N/A	N/A	N/A
MP033#170-B--	17	140	1.4	76	42	21.18	92	90	120.0	6	116	N/A	N/A	N/A
MP033#180-B--	18	140	1.3	73	40	22.76	89	90	190.0	4	116	N/A	N/A	N/A
MP033#190-B--	19	140	1.3	69	38	24.37	84	89	N/A	N/A	N/A	N/A	N/A	N/A
MP033#200-B--	20	135	1.2	65	36	25.98	80	89	N/A	N/A	N/A	N/A	N/A	N/A
MP033#220-B--	22	135	1.2	57	31	29.21	72	87	N/A	N/A	N/A	N/A	N/A	N/A
MP033#240-B--	24	135	1.2	48	26	34.44	62	87	N/A	N/A	N/A	N/A	N/A	N/A
U_R = 50V (Voltage code 5)														
MP035#R05-B--	0.05	N/A	25.6	1200	660	0.06	1333	945	0.06	556	832	0.06	397	880
MP035#R1-B--	0.1	6000	18.1	1156	636	0.11	1284	675	0.11	535	628	0.11	382	667
MP035#R15-B--	0.15	4800	14.8	1111	611	0.16	1235	555	0.16	514	533	0.16	367	567
MP035#R2-B--	0.2	3600	12.8	1067	587	0.21	1185	483	0.21	494	474	0.22	353	505
MP035#R25-B--	0.25	2700	11.4	1022	562	0.26	1136	433	0.27	473	433	0.27	338	462
MP035#R3-B--	0.3	1800	10.4	978	538	0.31	1086	397	0.32	453	402	0.32	323	430
MP035#R35-B--	0.35	1650	9.7	933	513	0.36	1037	368	0.37	432	378	0.37	309	404
MP035#R4-B--	0.4	1500	9.0	889	489	0.41	988	345	0.42	412	358	0.42	294	383
MP035#R45-B--	0.45	1400	8.5	844	464	0.46	938	326	0.47	391	341	0.48	279	365
MP035#R5-B--	0.5	1300	8.1	800	440	0.51	889	310	0.52	370	327	0.53	265	350
MP035#R55-B--	0.55	1200	7.7	788	434	0.57	875	296	0.57	363	315	0.58	261	337
MP035#R6-B--	0.6	1100	7.4	777	427	0.62	860	283	0.62	356	304	0.63	258	326
MP035#R65-B--	0.65	1025	7.1	765	421	0.67	846	273	0.67	348	294	0.68	255	315
MP035#R7-B--	0.7	950	6.8	754	414	0.72	832	263	0.72	341	285	0.73	252	306
MP035#R75-B--	0.75	900	6.6	742	408	0.77	817	254	0.78	334	277	0.79	248	298
MP035#R8-B--	0.8	800	6.4	730	402	0.82	803	247	0.83	326	270	0.84	245	290
MP035#R85-B--	0.85	750	6.2	719	395	0.87	789	239	0.88	319	264	0.89	242	283
MP035#R9-B--	0.9	700	6.0	707	389	0.92	775	233	0.93	312	258	0.95	239	277
MP035#R95-B--	0.95	650	5.9	696	383	0.97	760	227	0.98	304	252	1.00	235	271
MP035#R10-B--	1	600	5.7	684	376	1.019	746	216	1.061	297	242	1.101	232	260
Contact Factory	1.05	575	5.6	667	367	1.076	731	213	1.126	290	239	1.171	226	256
MP035#R1-B--	1.1	550	5.4	649	357	1.134	717	210	1.190	282	236	1.241	220	253
U_R = 50V (Voltage code 5)														
MP031#R05-B--	0.05	N/A	25.6	1200	660	0.06	1333	945	0.06	556	832	0.06	397	880
MP031#R1-B--	0.1	6000	18.1	1156	636	0.11	1284	675	0.11	535	628	0.11	382	667
MP031#R15-B--	0.15	4800	14.8	1111	611	0.16	1235	555	0.16	514	533	0.16	367	567
MP031#R2-B--	0.2	3600	12.8	1067	587	0.21	1185	483	0.21	494	474	0.22	353	505
MP031#R25-B--	0.25	2700	11.4	1022	562	0.26	1136	433	0.27	473	433	0.27	338	462
MP031#R3-B--	0.3	1800	10.4	978	538	0.31	1086	397	0.32	453	402	0.32	323	430
MP031#R35-B--	0.35	1650	9.7	933	513	0.36	1037	368	0.37	432	378	0.37	309	404
MP031#R4-B--	0.4	1500	9.0	889	489	0.41	988	345	0.42	412	358	0.42	294	383
MP031#R45-B--	0.45	1400	8.5	844	464	0.46	938	326	0.47	391	341	0.48	279	365
MP031#R5-B--	0.5	1300	8.1	800	440	0.51	889	310	0.52	370	327	0.53	265	350
MP031#R55-B--	0.55	1200	7.7	788	434	0.57	875	296	0.57	363	315	0.58	261	337
MP031#R6-B--	0.6	1100	7.4	777	427	0.62	860	283	0.62	356	304	0.63	258	326
MP031#R65-B--	0.65	1025	7.1	765	421	0.67	846	273	0.67	348	294	0.68	255	315
MP031#R7-B--	0.7	950	6.8	754	414	0.72	832	263	0.72	341	285	0.73	252	306
MP031#R75-B--	0.75	900	6.6	742	408	0.77	817	254	0.78	334	277	0.79	248	298
MP031#R8-B--	0.8	800	6.4	730	402	0.82	803	247	0.83	326	270	0.84	245	290
MP031#R85-B--	0.85	750	6.2	719	395	0.87	789	239	0.88	319	264	0.89	242	283
MP031#R9-B--	0.9	700	6.0	707	389	0.92	775	233	0.93	312	258	0.95	239	277

"#"=can be either "J" or "K" temperature coefficient

Accu-P[®] MP Medical Grade

High Frequency Characteristics



Accu-P[®] MP 0201 Typical SRF vs. Capacitance

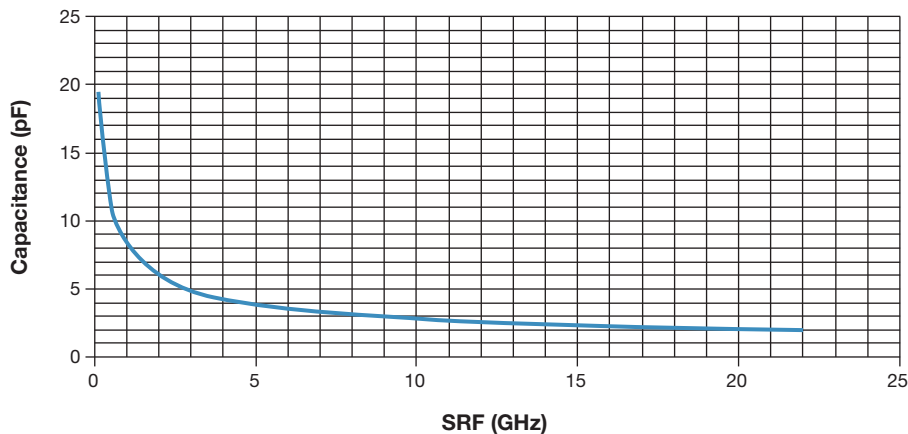

Accu-P[®] MP 0201 Typical ESR vs. Frequency

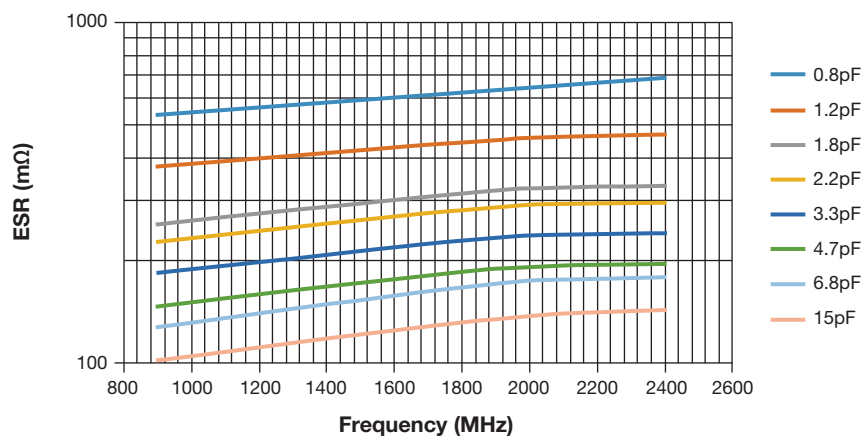

Accu-P[®] MP 0201 Typical Q vs. Frequency

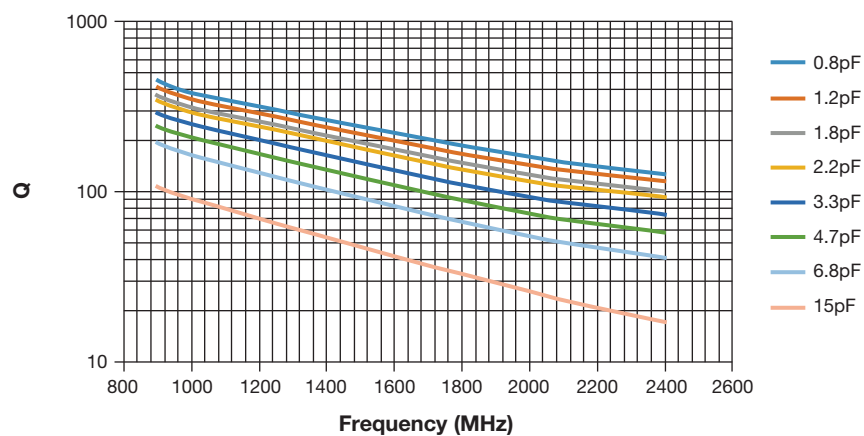

Accu-P[®] MP Medical Grade

High Frequency Characteristics



Accu-P[®] MP 0402 Typical SRF vs. Capacitance

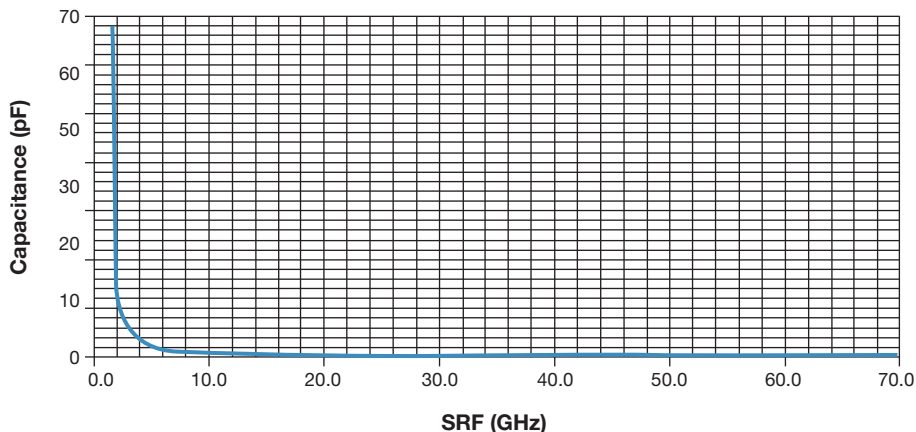

Accu-P[®] MP 0402 Typical ESR vs. Frequency

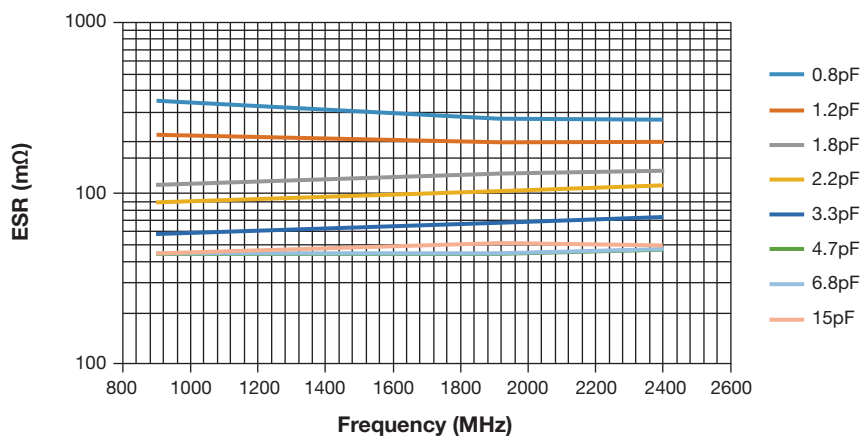

Accu-P[®] MP 0402 Typical Q vs. Frequency

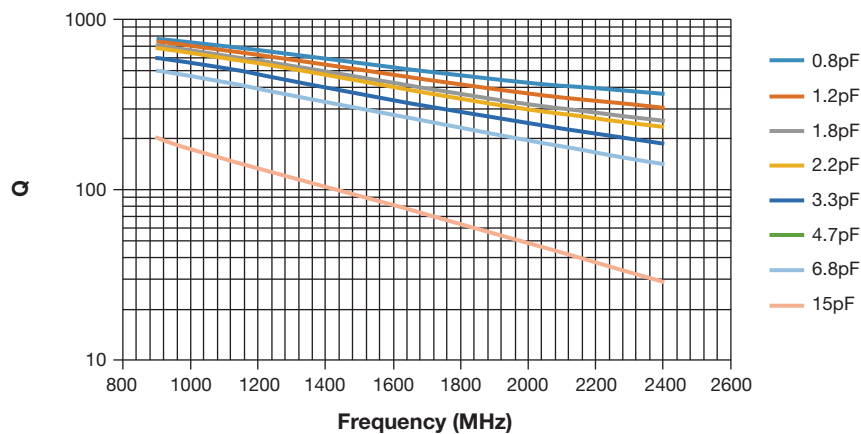

Accu-P[®] MP Medical Grade

High Frequency Characteristics



Accu-P[®] MP 0603 Typical SRF vs. Capacitance

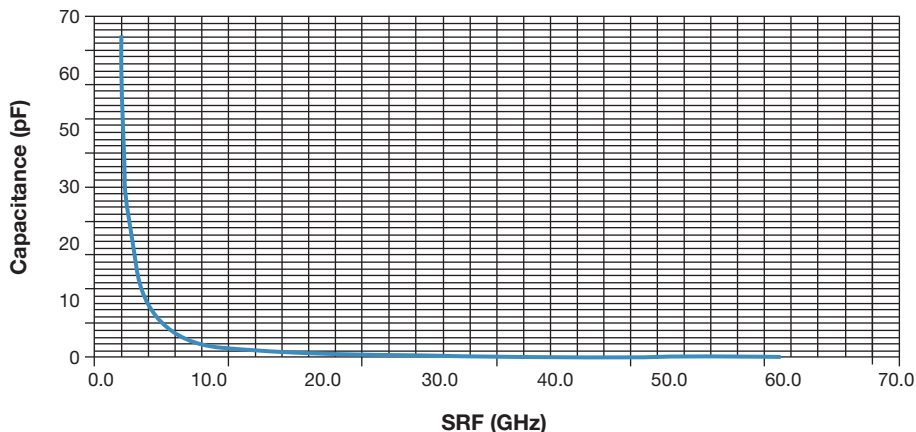

Accu-P[®] MP 0603 Typical ESR vs. Frequency

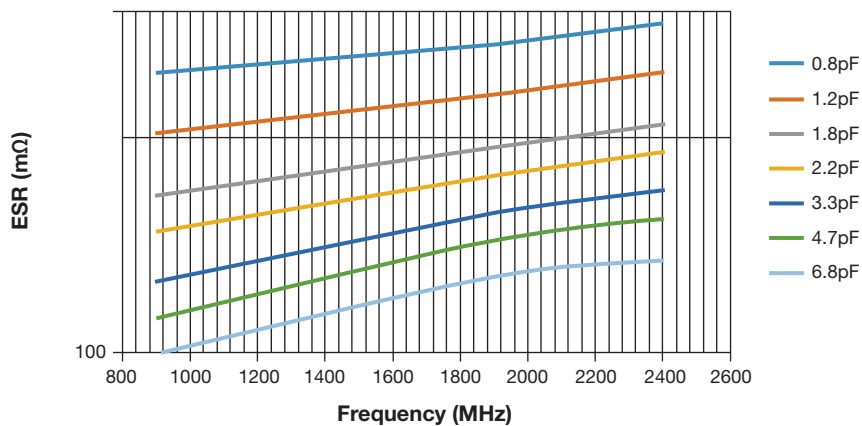

Accu-P[®] MP 0603 Typical Q vs. Frequency

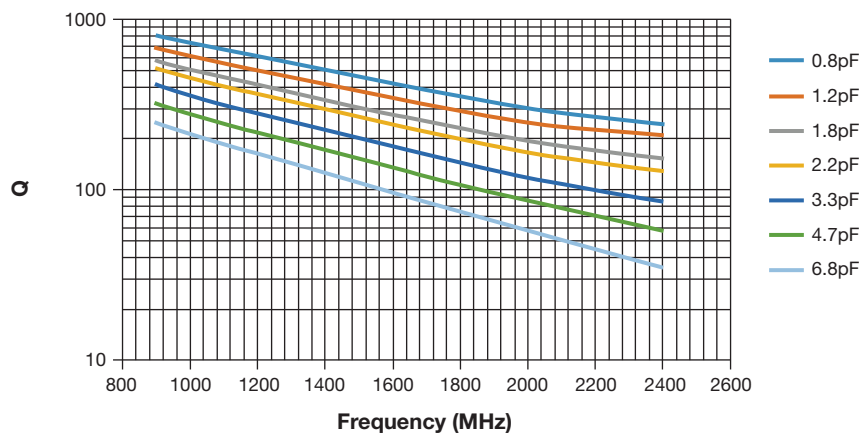

Accu-P® MP Medical Grade

Environmental / Mechanical Characteristics



ENVIRONMENTAL CHARACTERISTICS

TEST	CONDITIONS	REQUIREMENT
Life (Endurance) MIL-STD-202F Method 108A	125°C, 2U _R , 1000 hours	No visible damage $\Delta C/C \leq 2\%$ for $C \geq 5\text{pF}$ $\Delta C \leq 0.25\text{pF}$ for $C < 5\text{pF}$
Accelerated Damp Heat Steady State MIL-STD-202F Method 103B	85°C, 85% RH, U _R , 1000 hours	No visible damage $\Delta C/C \leq 2\%$ for $C \geq 5\text{pF}$ $\Delta C \leq 0.25\text{pF}$ for $C < 5\text{pF}$
Temperature Cycling MIL-STD-202F Method 107E MIL-STD-883D Method 1010.7	-55°C to +125°C, 15 cycles – Accu-P®	No visible damage $\Delta C/C \leq 2\%$ for $C \geq 5\text{pF}$ $\Delta C \leq 0.25\text{pF}$ for $C < 5\text{pF}$
Resistance to Solder Heat IEC-68-2-58	260°C \pm 5°C for 10 secs	C remains within initial limits

MECHANICAL CHARACTERISTICS

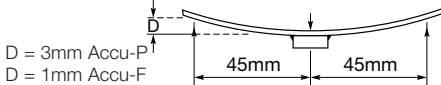
TEST	CONDITIONS	REQUIREMENT
Solderability IEC-68-2-58	Components completely immersed in a solder bath at 235°C for 2 secs.	Terminations to be well tinned, minimum 95% coverage
Leach Resistance IEC-68-2-58	Components completely immersed in a solder bath at 260 \pm 5°C for 60 secs.	Dissolution of termination faces $\leq 15\%$ of area Dissolution of termination edges $\leq 25\%$ of length
Adhesion MIL-STD-202F Method 211A	A force of 5N applied for 10 secs.	No visible damage
Termination Bond Strength IEC-68-2-21 Amend. 2	Tested as shown in diagram  D = 3mm Accu-P D = 1mm Accu-F	No visible damage $\Delta C/C \leq 2\%$ for $C \geq 5\text{pF}$ $\Delta C \leq 0.25\text{pF}$ for $C < 5\text{pF}$
Robustness of Termination IEC-68-2-21 Amend. 2	A force of 5N applied for 10 secs.	No visible damage
High Frequency Vibration MIL-STD-202F Method 201A, 204D (Accu-P® only)	55Hz to 2000Hz, 20G	No visible damage
Storage	12 months minimum with components stored in “as received” packaging	Good solderability

QUALITY & RELIABILITY

Accu-P® is based on well established thin-film technology and materials.

• ON-LINE PROCESS CONTROL

This program forms an integral part of the production cycle and acts as a feedback system to regulate and control production processes. The test procedures, which are integrated into the production process, were developed after long research work and are based on the highly developed semiconductor industry test procedures and equipment. These measures help AVX to produce a consistent and high yield line of products.

• FINAL QUALITY INSPECTION

Finished parts are tested for standard electrical parameters and visual/mechanical characteristics. Each production lot is 100% evaluated for: capacitance and proof voltage at 2.5 U_R. In addition, production is periodically evaluated for:

Average capacitance with histogram printout for capacitance distribution;
IR and Breakdown Voltage distribution;
Temperature Coefficient;
Solderability;
Dimensional, mechanical and temperature stability.

QUALITY ASSURANCE

The reliability of these thin-film chip capacitors has been studied intensively for several years. Various measures have been taken to obtain the high reliability required today by the industry. Quality assurance policy is based on well established international industry standards. The reliability of the capacitors is determined by accelerated testing under the following conditions:

Life (Endurance)	125°C, 2U _R , 1000 hours
Accelerated Damp Heat Steady State	85°C, 85% RH, U _R , 1000 hours.

Performance Characteristics RF Power Applications

RF POWER APPLICATIONS

In RF power applications capacitor losses generate heat. Two factors of particular importance to designers are:

- Minimizing the generation of heat.
- Dissipating heat as efficiently as possible.

CAPACITOR HEATING

- The major source of heat generation in a capacitor in RF power applications is a function of RF current (I) and ESR, from the relationship:

$$\text{Power dissipation} = I_{\text{RMS}}^2 \times \text{ESR}$$

- Accu-P® capacitors are specially designed to minimize

ESR and therefore RF heating. Values of ESR for Accu-P® capacitors are significantly less than those of ceramic MLC components currently available.

HEAT DISSIPATION

- Heat is dissipated from a capacitor through a variety of paths, but the key factor in the removal of heat is the thermal conductivity of the capacitor material.
- The higher the thermal conductivity of the capacitor, the more rapidly heat will be dissipated.
- The table below illustrates the importance of thermal conductivity to the performance of Accu-P® in power applications.

PRODUCT	MATERIAL	THERMAL CONDUCTIVITY W/mK
Accu-P®	Alumina	18.9
Microwave MLC	Magnesium Titanate	6.0

**Power Handling
Accu-P® 10pF**

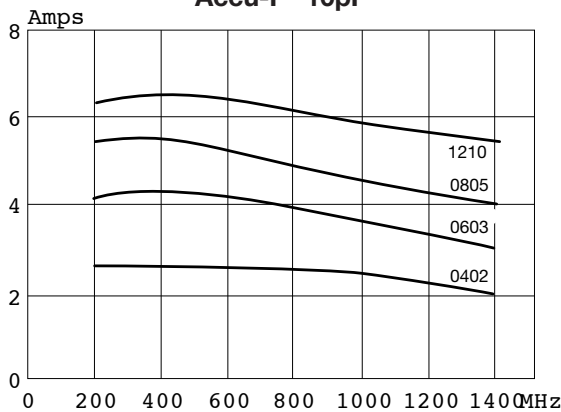

Data used in calculating the graph:

Thermal impedance of capacitors:

0402	17°C/W
0603	12°C/W
0805	6.5°C/W
1210	5°C/W

Thermal impedance measured using RF generator, amplifier and strip-line transformer.

ESR of capacitors measured on Boonton 34A

THERMAL IMPEDANCE

Thermal impedance of Accu-P® chips is shown below compared with the thermal impedance of Microwave MLC's.

CAPACITOR TYPE	CHIP SIZE	THERMAL IMPEDANCE (°C/W)
Accu-P®	0805	6.5
	1210	5
Microwave MLC	0505	12
	1210	7.5

The thermal impedance expresses the temperature difference in °C between chip center and termination caused by a power dissipation of 1 watt in the chip. It is expressed in °C/W.

ADVANTAGES OF ACCU-P® IN RF POWER CIRCUITS

The optimized design of Accu-P® offers the designer of RF power circuits the following advantages:

- Reduced power losses due to the inherently low ESR of Accu-P®.
- Increased power dissipation due to the high thermal conductivity of Accu-P®.

• THE ONLY TRUE TEST OF A CAPACITOR IN ANY PARTICULAR APPLICATION IS ITS PERFORMANCE UNDER OPERATING CONDITIONS IN THE ACTUAL CIRCUIT.

PRACTICAL APPLICATION IN RF POWER CIRCUITS

- There is a wide variety of different experimental methods for measuring the power handling performance of a capacitor in RF power circuits. Each method has its own problems and few of them exactly reproduce the conditions present in "real" circuit applications.
- Similarly, there is a very wide range of different circuit applications, all with their unique characteristics and operating conditions which cannot possibly be covered by such "theoretical" testing.

Application Notes

GENERAL

Accu-P[®] SMD capacitors are designed for soldering to printed circuit boards or other substrates. The construction of the components is such that they will withstand the time/temperature profiles used in both wave and reflow soldering methods.

CIRCUIT BOARD TYPE

The circuit board types which may be used with Accu-P[®] are as follows:

All flexible types of circuit boards (eg. FR-4, G-10) and also alumina.

For other circuit board materials, please consult factory.

HANDLING

SMD capacitors should be handled with care to avoid damage or contamination from perspiration and skin oils. The use of plastic tipped tweezers or vacuum pick-ups is strongly recommended for individual components. Bulk handling should ensure that abrasion and mechanical shock are minimized. For automatic equipment, taped and reeled product gives the ideal medium for direct presentation to the placement machine.

COMPONENT PAD DESIGN

Component pads must be designed to achieve good joints and minimize component movement during reflow soldering. Pad designs are given below for both wave and reflow soldering.

The basis of these designs is:

- Pad width equal to component width. It is permissible to decrease this to as low as 85% of component width but it is not advisable to go below this.
- Pad overlap 0.5mm beneath large components. Pad overlap about 0.3mm beneath small components.
- Pad extension of 0.5mm for reflow of large components and pad extension about 0.3mm for reflow of small components. Pad extension about 1.0mm for wave soldering.

REFLOW SOLDERING

PAD DIMENSIONS: millimeters (inches)

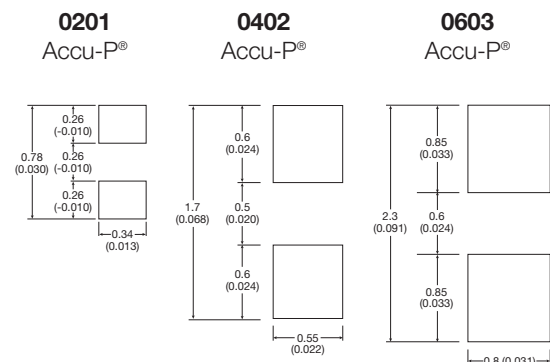

Application Notes

PREHEAT & SOLDERING

The rate of preheat in production should not exceed 4°C/second and a recommended maximum is about 2°C/second. Temperature differential from preheat to soldering should not exceed 100°C.

For further specific application or process advice, please consult AVX.

COOLING

After soldering, the assembly should preferably be allowed to cool naturally. In the event of assisted cooling, similar conditions to those recommended for preheating should be used.

HAND SOLDERING & REWORK

Hand soldering is permissible. Preheat of the PCB to 150°C is required. The most preferable technique is to use hot air soldering tools. Where a soldering iron is used, a temperature controlled model not exceeding 30 watts should be used and set to not more than 260°C.

CLEANING RECOMMENDATIONS

Care should be taken to ensure that the devices are thoroughly cleaned of flux residues, especially the space beneath the device. Such residues may otherwise become conductive and effectively offer a lossy bypass to the device. Various recommended cleaning conditions (which must be optimized for the flux system being used) are as follows:

Cleaning liquids. i-propanol, ethanol, acetylacetone, water and other standard PCB cleaning liquids.

Ultrasonic conditions . . power-20w/liter max.
frequency-20kHz to 45kHz.

Temperature 80°C maximum (if not otherwise limited by chosen solvent system).

Time 5 minutes max.

STORAGE CONDITIONS

Recommended storage conditions for Accu-P[®] prior to use are as follows:

Temperature 15°C to 35°C

Humidity ≤65%

Air Pressure 860mbar to 1060mbar

RECOMMENDED REFLOW SOLDERING PROFILE COMPONENTS WITH SnPb TERMINATIONS

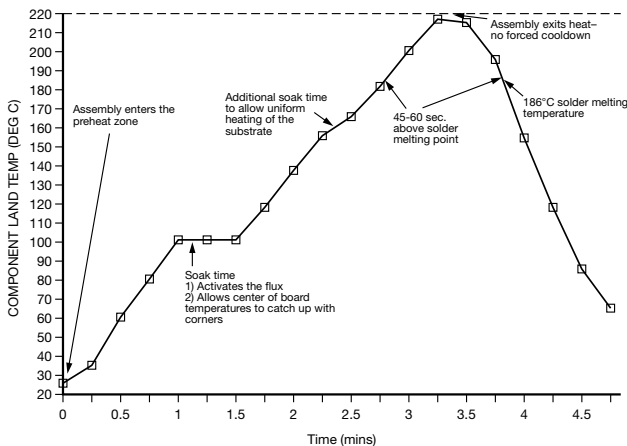

RECOMMENDED REFLOW SOLDERING PROFILE LEAD FREE COMPONENTS WITH Sn100 TERMINATIONS

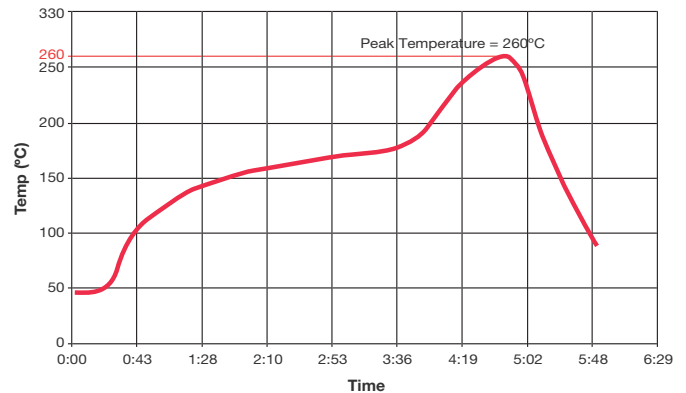

Automatic Insertion Packaging

TAPE & REEL

All tape and reel specifications are in compliance with EIA 481-1-A.
(equivalent to IEC 286 part 3).

- 8mm carrier
- Reeled quantities: Reels of 3,000 per 7" reel or 10,000 pieces per 13" reel
01005, 0201 and 0402 = 5,000 pieces per 7" reel and 20,000 pieces per 13" reel

REEL

DIMENSIONS: millimeters (inches)

A ⁽¹⁾	B	C	D	E	F	G
180±1.0 (7.087±0.039)	1.5 min. (0.059 min.)	13±0.2 (0.512 ± 0.008)	20.2 min. (0.795 min.)	50 min. (1.969 min.)	9.6±1.5 (0.370 ± 0.050)	14.4 max. (0.567 max.)

Metric dimensions will govern.
Inch measurements rounded and for reference only.

(1) 330mm (13 inch) reels are available.

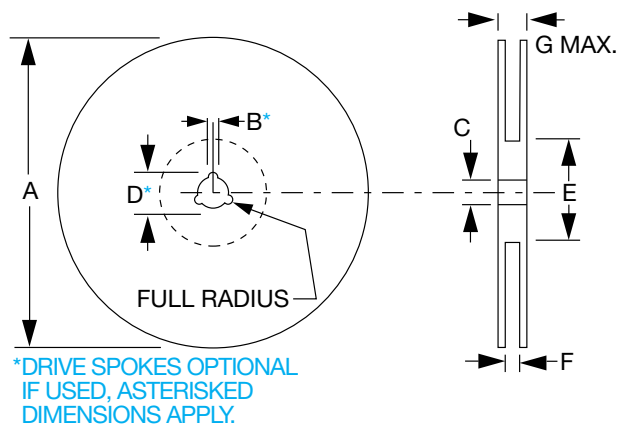

CARRIER

DIMENSIONS: millimeters (inches)

A	B	C	D	E	F
8.0 ± 0.3 (0.315 ± 0.012)	3.5 ± 0.05 (0.138 ± 0.002)	1.75±0.1 (0.069 ± 0.004)	2.0 ± 0.05 (0.079 ± 0.002)	4.0 ± 0.1 (0.157 ± 0.004)	1.5 ^{+0.1} _{-0.0} (0.059 ^{+0.004} _{-0.000})

The nominal dimensions of the component compartment (W,L) are derived from the component size.

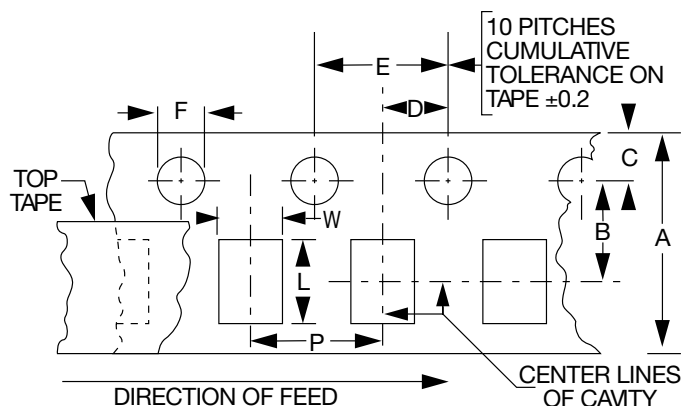

P = 4mm for 0603, 0805, 1210
P = 2mm for C005, 0201 and 0402

AVX reserves the right to change the information published herein without notice.