



Typical Applications

The HMC683LP6C(E) is ideal for:

- Cellular/3G & LTE/WiMAX/4G
- Basestations & Repeaters
- GSM, CDMA & OFDM
- Dual Density Receivers

Features

- High Input IP3: +23 dBm
- Conversion Gain: 7.5 dB
- Low LO Drive: 0 dBm
- High Channel Isolation
- 40 Lead 6x6mm SMT Package: 36mm²

Functional Diagram

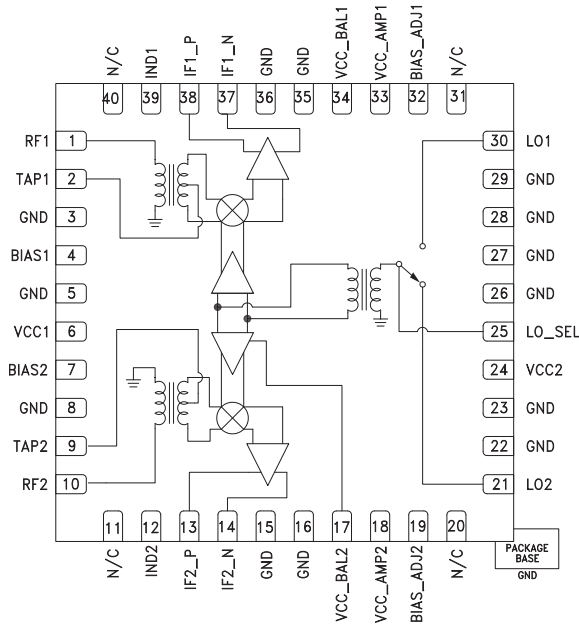

General Description

The HMC683LP6C(E) is a high linearity, dual channel downconverter with integrated LO amplifier in a 6x6 SMT QFN package covering 0.7 - 1.0 GHz. Excellent input IP3 performance of +23 dBm for down conversion is provided for 3G & 4G GSM/CDMA applications at an LO drive of 0 dBm. With an input 1 dB compression of +11 dBm, the RF port will accept a wide range of input signal levels. Conversion gain is 7.5 dB typical. The 60 - 500 MHz IF frequency response will satisfy various GSM/CDMA receive frequency plans.

Electrical Specifications, $T_A = +25^\circ\text{C}$, IF - 100 MHz, LO = 0 dBm

$V_{CC1, 2} = V_{CC_BAL1, 2} = V_{CC_AMP1, 2} [1] = V_{CC_IF1P, N} = V_{CC_IF2P, N} = +5V$, $BIAS1, 2 = +2.5V$

| Parameter | Min. | Typ. | Max. | Units |
|-----------------------------------|------|------------|------|-------|
| Frequency Range, RF | | 700 - 1000 | | MHz |
| Frequency Range, LO | | 570 - 900 | | MHz |
| Frequency Range, IF | | 60 - 500 | | MHz |
| Conversion Gain | 5 | 7.5 | | dB |
| Noise Figure (SSB) | | 11 | | dB |
| LO to RF Isolation | 10 | 16 | | dB |
| LO to IF Isolation | 15 | 20 | | dB |
| RF to IF Isolation | 19 | 28 | | dB |
| IP3 (Input) | | 23 | | dBm |
| 1 dB Compression (Input) | | 11 | | dBm |
| Channel to Channel Isolation | | 50 | | dB |
| LO Drive Input Level (Typical) | | -3 to +3 | | dBm |
| Supply Current (I _{cc}) | | 420 | 520 | mA |

[1] See Application Circuit [2] Unless otherwise noted all measurements with low side LO & IF = 100 MHz.

Information furnished by Analog Devices is believed to be accurate and reliable. However, no responsibility is assumed by Analog Devices for its use, nor for any infringements of patents or other rights of third parties that may result from its use. Specifications subject to change without notice. No license is granted by implication or otherwise under any patent or patent rights of Analog Devices. Trademarks and registered trademarks are the property of their respective owners.

For price, delivery, and to place orders: Analog Devices, Inc., One Technology Way, P.O. Box 9106, Norwood, MA 02062-9106 Phone: 781-329-4700 • Order online at www.analog.com Application Support: Phone: 1-800-ANALOG-D

HMC683* PRODUCT PAGE QUICK LINKS

Last Content Update: 11/29/2017

COMPARABLE PARTS

View a parametric search of comparable parts.

EVALUATION KITS

- HMC683LP6C Evaluation Board

DOCUMENTATION

Data Sheet

- HMC683 Data Sheet

REFERENCE MATERIALS

Product Selection Guide

- RF, Microwave, and Millimeter Wave IC Selection Guide 2017

Quality Documentation

- HMC Legacy PCN: LP6CE and LP6GE QFN - Alternate assembly source
- Package/Assembly Qualification Test Report: LP4, LP4B, LP4C, LP4K (QTR: 2013-00487 REV: 04)
- Package/Assembly Qualification Test Report: Plastic Encapsulated QFN (QTR: 05006 REV: 02)
- Semiconductor Qualification Test Report: BiCMOS-A (QTR: 2013-00235)

DESIGN RESOURCES

- HMC683 Material Declaration
- PCN-PDN Information
- Quality And Reliability
- Symbols and Footprints

DISCUSSIONS

View all HMC683 EngineerZone Discussions.

SAMPLE AND BUY

Visit the product page to see pricing options.

TECHNICAL SUPPORT

Submit a technical question or find your regional support number.

DOCUMENT FEEDBACK

Submit feedback for this data sheet.

This page is dynamically generated by Analog Devices, Inc., and inserted into this data sheet. A dynamic change to the content on this page will not trigger a change to either the revision number or the content of the product data sheet. This dynamic page may be frequently modified.



**HIGH IP3 DUAL CHANNEL
DOWNCONVERTER w/ LO SWITCH, 0.7 - 1.0 GHz**

**Single Channel:
Conversion Gain vs. Temperature**

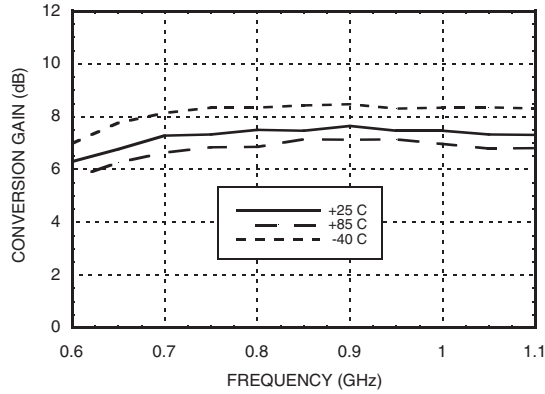

Single Channel: Isolation

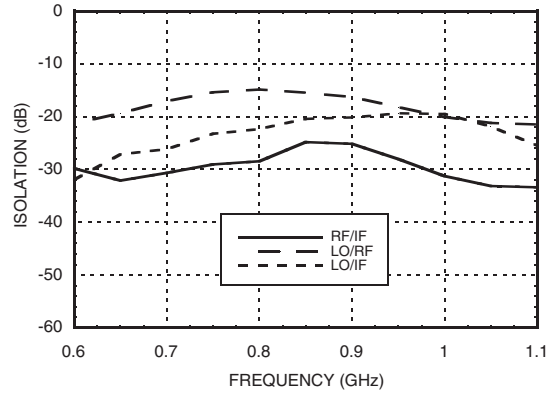

**Single Channel:
Conversion Gain vs. LO Drive**

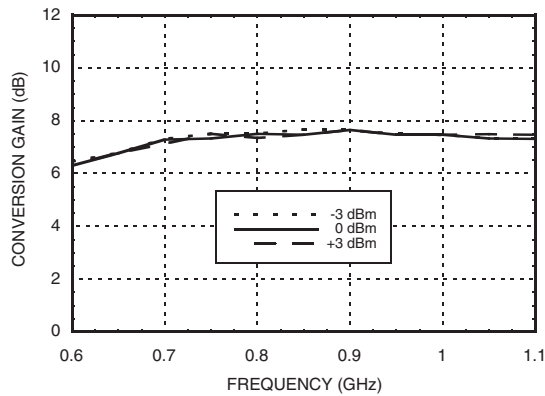

Single Channel: Return Loss

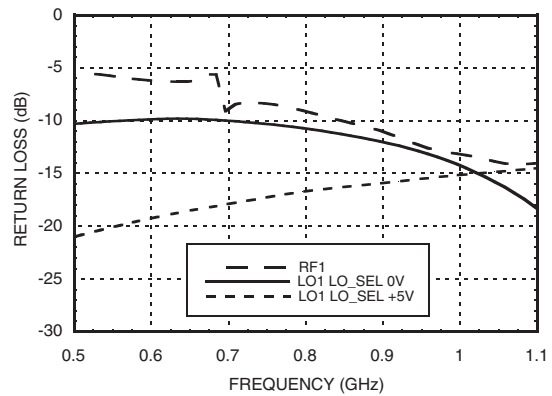

Single Channel: IF Bandwidth

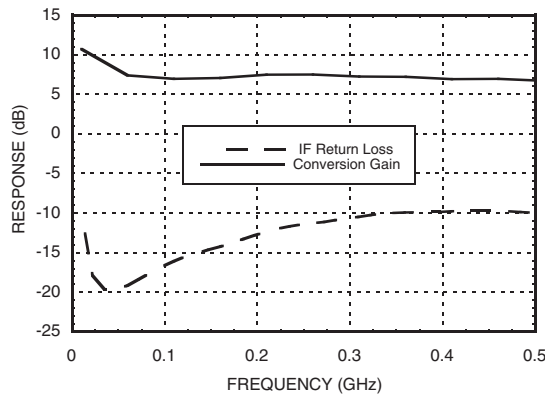

**Single Channel:
Input P1dB vs. Temperature**

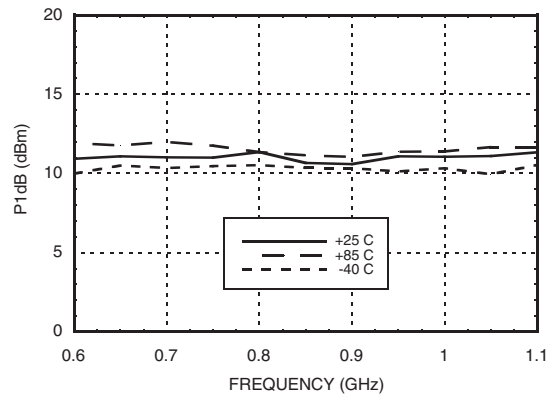

Information furnished by Analog Devices is believed to be accurate and reliable. However, no responsibility is assumed by Analog Devices for its use, nor for any infringements of patents or other rights of third parties that may result from its use. Specifications subject to change without notice. No license is granted by implication or otherwise under any patent or patent rights of Analog Devices. Trademarks and registered trademarks are the property of their respective owners.

For price, delivery, and to place orders: Analog Devices, Inc., One Technology Way, P.O. Box 9106, Norwood, MA 02062-9106 Phone: 781-329-4700 • Order online at www.analog.com Application Support: Phone: 1-800-ANALOG-D



**HIGH IP3 DUAL CHANNEL
DOWNCONVERTER w/ LO SWITCH, 0.7 - 1.0 GHz**

9

MIXERS - DOWNCONVERTERS - SMT

Single Channel: Input IP3 vs. LO Drive

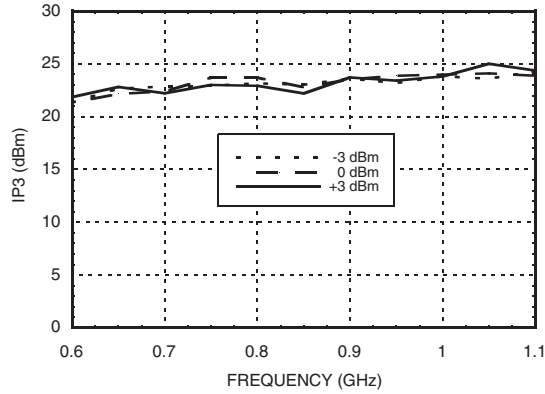

**Single Channel:
Input IP3 vs. Temperature**

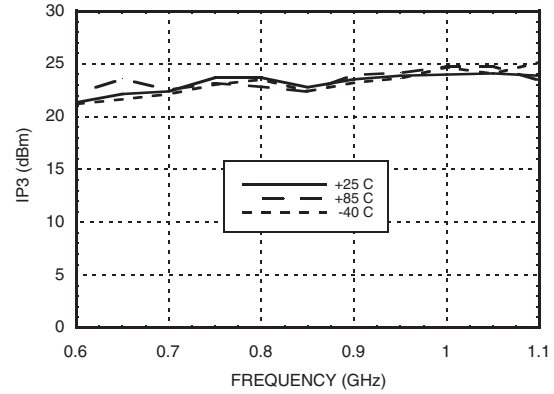

**Dual Channel:
Channel to Channel Isolation [1]**

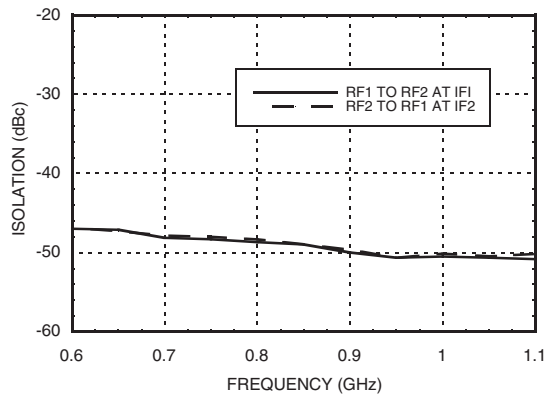

Dual Channel: LO1 to LO2 Isolation [2]

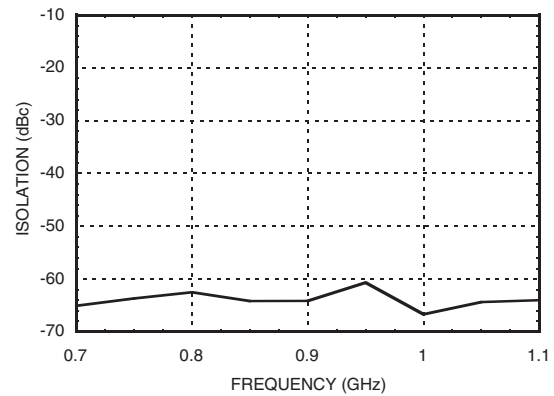

Noise Figure vs. Temperature

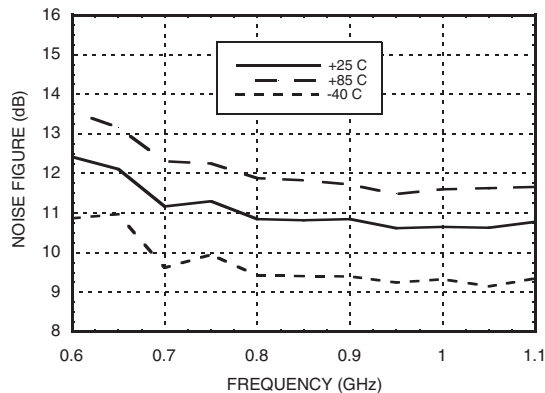

[1] For 900 MHz, RF1 = 900 MHz @ 0 dBm, RF2 = 901 MHz @ 0 dBm, LO = 800 MHz @ 0 dBm, IF2 terminated with 50 Ohms. Channel isolation is the dBc difference at IF1 port between the fundamental tone @ 100 MHz and the leakage tone @ 101 MHz.

[2] For 900 MHz, LO1 = 800 MHz @ 0 dBm, LO2 = 799 MHz @ 0 dBm, LO1 is selected, RF1 = RF2 = 900 MHz @ 0 dBm, IF2 terminated with 50 Ohms. LO1-LO2 isolation is the dBc difference measured at the IF1 port between the fundamental tone at 100 MHz and the leakage tone @ 101 MHz.



**HIGH IP3 DUAL CHANNEL
DOWNCONVERTER w/ LO SWITCH, 0.7 - 1.0 GHz**

+2RF -2LO Response vs. Temperature [3]

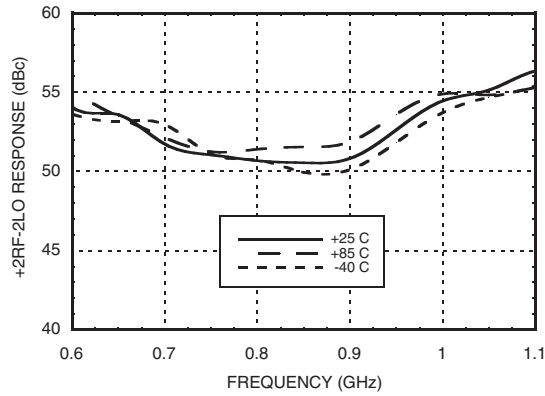

+2RF -2LO Response vs. LO Drive [3]

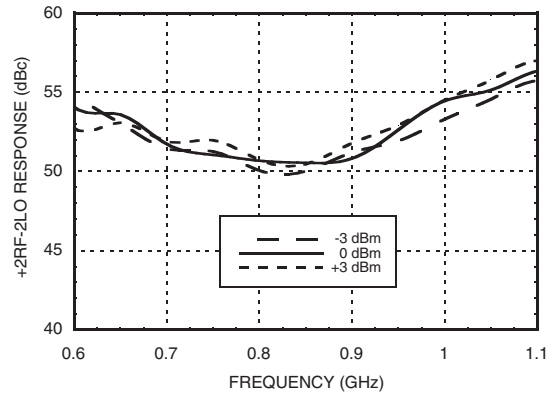

+3RF -3LO Response vs. Temperature [3]

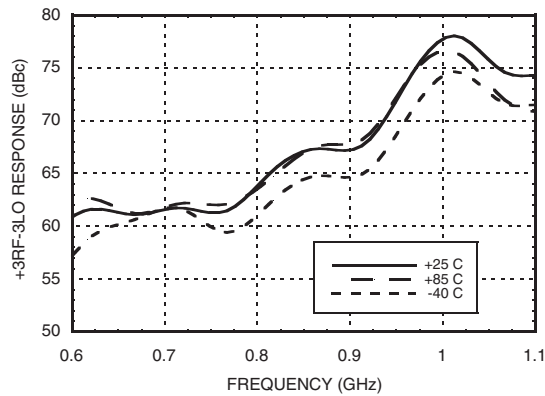

+3RF -3LO Response vs. LO Drive [3]

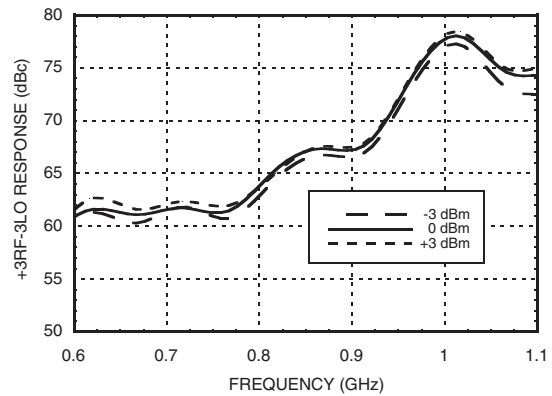

[1] Referenced to RF Input Power @ 0 dBm

Information furnished by Analog Devices is believed to be accurate and reliable. However, no responsibility is assumed by Analog Devices for its use, nor for any infringements of patents or other rights of third parties that may result from its use. Specifications subject to change without notice. No license is granted by implication or otherwise under any patent or patent rights of Analog Devices. Trademarks and registered trademarks are the property of their respective owners.

For price, delivery, and to place orders: Analog Devices, Inc., One Technology Way, P.O. Box 9106, Norwood, MA 02062-9106
Phone: 781-329-4700 • Order online at www.analog.com
Application Support: Phone: 1-800-ANALOG-D

**HIGH IP3 DUAL CHANNEL
DOWNCONVERTER w/ LO SWITCH, 0.7 - 1.0 GHz**
MxN Spurious @ IF Port

| mRF | nLO | | | | |
|-----|-----|----|----|----|----|
| | 0 | 1 | 2 | 3 | 4 |
| 0 | xx | 23 | 16 | 22 | 28 |
| 1 | 34 | 0 | 38 | 16 | 45 |
| 2 | 55 | 50 | 56 | 59 | 82 |
| 3 | 88 | 57 | 82 | 63 | 88 |
| 4 | 93 | 94 | 92 | 94 | 94 |

RF Freq. = 0.9 GHz @ -5 dBm
LO Freq. = 0.8 GHz @ 0 dBm
All values in dBc below IF power level (1RF - 1LO).

Harmonics of LO

| LO Freq. (GHz) | nLO Spur @ RF Port | | | |
|----------------|--------------------|----|----|----|
| | 1 | 2 | 3 | 4 |
| 0.6 | 17 | 33 | 36 | 37 |
| 0.7 | 15 | 25 | 34 | 39 |
| 0.8 | 17 | 24 | 33 | 30 |
| 0.9 | 20 | 26 | 35 | 25 |
| 1.0 | 21 | 28 | 41 | 54 |
| 1.1 | 23 | 29 | 53 | 57 |

LO = 0 dBm
All values in dBc below input LO level measured at RF port.

Typical Supply Current vs. Vcc

| Vcc | Icc (A) |
|------|---------|
| 4.75 | 390 |
| 5.00 | 420 |
| 5.25 | 450 |

Downconverter will operate over full voltage range shown above.

Truth Table

| LO_SEL (V) | LO Signal Path |
|------------|----------------|
| 0 | LO1 |
| 5 | LO2 |

Absolute Maximum Ratings

| | |
|---|---------------|
| RF / IF Input (Vcc= +5V) | +15 dBm |
| LO Drive (Vcc= +5V) | +6 dBm |
| Vcc (LO or IF) | 5.5V |
| Channel Temperature | 12.5°C |
| Continuous Pdiss (T = 85°C) (derate 110.53 mW/°C above 85°C) | 4.42 W |
| Thermal Resistance (channel to ground paddle) | 9.05 °C/W |
| Storage Temperature | -65 to 150°C |
| Operating Temperature | -40 to +85 °C |

**ELECTROSTATIC SENSITIVE DEVICE
OBSERVE HANDLING PRECAUTIONS**

HIGH IP3 DUAL CHANNEL DOWNCONVERTER w/ LO SWITCH, 0.7 - 1.0 GHz



Outline Drawing

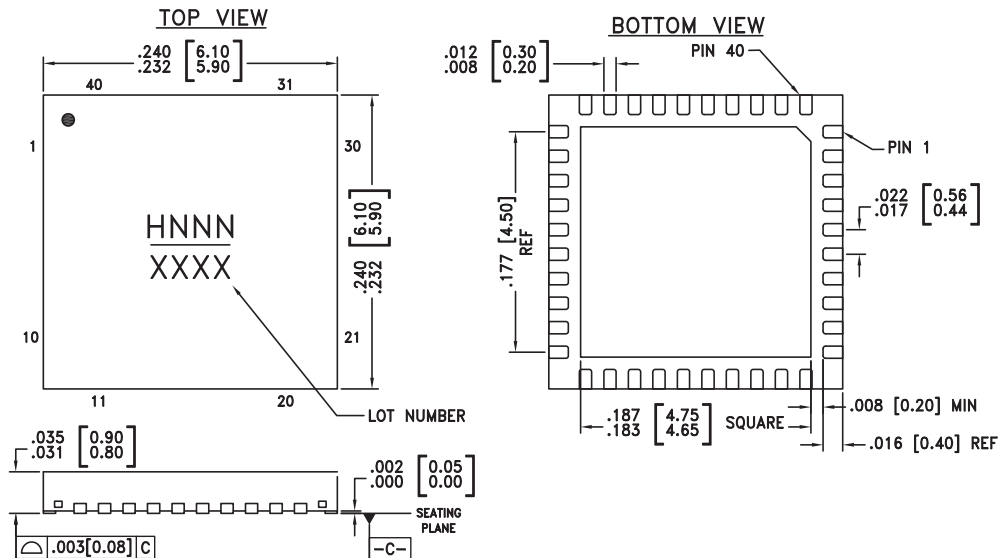

NOTES:

1. PACKAGE BODY MATERIAL: LOW STRESS INJECTION MOLDED PLASTIC SILICA AND SILICON IMPREGNATED.
2. LEAD AND GROUND PADDLE MATERIAL: COPPER ALLOY.
3. LEAD AND GROUND PADDLE PLATING: 100% MATTE TIN.
4. DIMENSIONS ARE IN INCHES [MILLIMETERS].
5. LEAD SPACING TOLERANCE IS NON-CUMULATIVE.
6. PAD BURR LENGTH SHALL BE 0.15mm MAX.
PAD BURR HEIGHT SHALL BE 0.25mm MAX.
7. PACKAGE WARP SHALL NOT EXCEED 0.05mm
8. ALL GROUND LEADS AND GROUND PADDLE MUST BE SOLDERED TO PCB RF GROUND.
9. REFER TO HITTITE APPLICATION NOTE FOR SUGGESTED PCB LAND PATTERN.

Package Information

| Part Number | Package Body Material | Lead Finish | MSL Rating | Package Marking ^[3] |
|-------------|--|---------------|---------------------|--------------------------------|
| HMC683LP6C | Low Stress Injection Molded Plastic | Sn/Pb Solder | MSL1 ^[1] | H683 XXXX |
| HMC683LP6CE | RoHS-compliant Low Stress Injection Molded Plastic | 100% matte Sn | MSL1 ^[2] | H683 XXXX |

[1] Max peak reflow temperature of 235 °C



[2] Max peak reflow temperature of 260 °C

[3] 4-Digit lot number XXXX

HIGH IP3 DUAL CHANNEL DOWNCONVERTER w/ LO SWITCH, 0.7 - 1.0 GHz

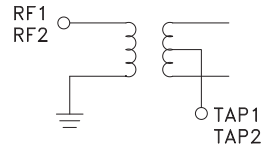

Pin Descriptions

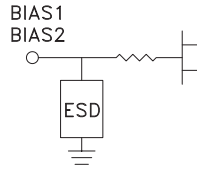
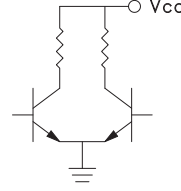
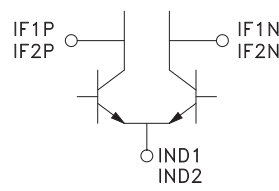
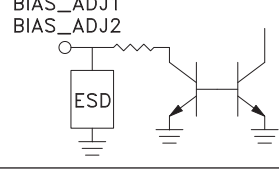
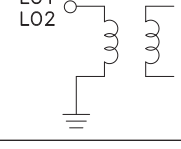
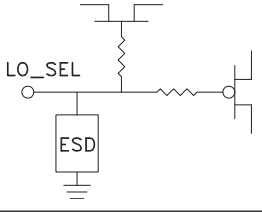
| Pin Number | Function | Description | Interface Schematic |
|--|---|---|---|
| 1, 10 | RF1, RF2 | These are the RF inputs of the mixers. See application circuit for the off-chip matching components |  |
| 2, 9 | TAP1, TAP2 | These are the center taps of the internal RF baluns. Connect these pins to the AC ground via external capacitors. See application circuit. | |
| 3, 5, 8, 15, 16, 22, 23, 26 - 29, 35, 36 | GND | These pins must be connected to RF ground. |  |
| 4, 7 | BIAS1, BIAS2 | Bias pins for mixer cores. See application circuit for the nominal value. |  |
| 6, 17, 18, 24, 33, 34 | Vcc1, Vcc_BAL2, Vcc_AMP2, Vcc2, Vcc_AMP1, Vcc_BAL1 | Power supply voltage pins. See application circuit for bypass capacitors required. |  |
| 11, 20, 31, 40 | N/C | No Connection required. These pins may be connected to RF GND without affecting performance. | |
| 12, 39 | IND1, IND2 | Current source inductors for IF amplifiers. |  |
| 13, 14, 38, 37 | IF2P, IF2N, IF1P, IF1N | Differential IF outputs and DC bias for IF amplifiers. | |
| 19, 32 | BIAS_ADJ1, BIAS_ADJ2 | Adjusts LO buffer amplifies current via external resistor. See application circuit. |  |
| 21, 30 | LO2, LO1 | These are LO inputs of the mixers. See application circuit for off-chip matching components. |  |
| 25 | LO_SEL | Control voltage for LO1 or LO2 selection. LO1 is selected when LO_SEL is set low. LO2 is selected when LO_SEL is set high. See application circuit and truth table for low and high voltage levels. |  |

Information furnished by Analog Devices is believed to be accurate and reliable. However, no responsibility is assumed by Analog Devices for its use, nor for any infringements of patents or other rights of third parties that may result from its use. Specifications subject to change without notice. No license is granted by implication or otherwise under any patent or patent rights of Analog Devices. Trademarks and registered trademarks are the property of their respective owners.

For price, delivery, and to place orders: Analog Devices, Inc., One Technology Way, P.O. Box 9106, Norwood, MA 02062-9106
Phone: 781-329-4700 • Order online at www.analog.com
Application Support: Phone: 1-800-ANALOG-D



**HIGH IP3 DUAL CHANNEL
DOWNCONVERTER w/ LO SWITCH, 0.7 - 1.0 GHz**

Evaluation PCB

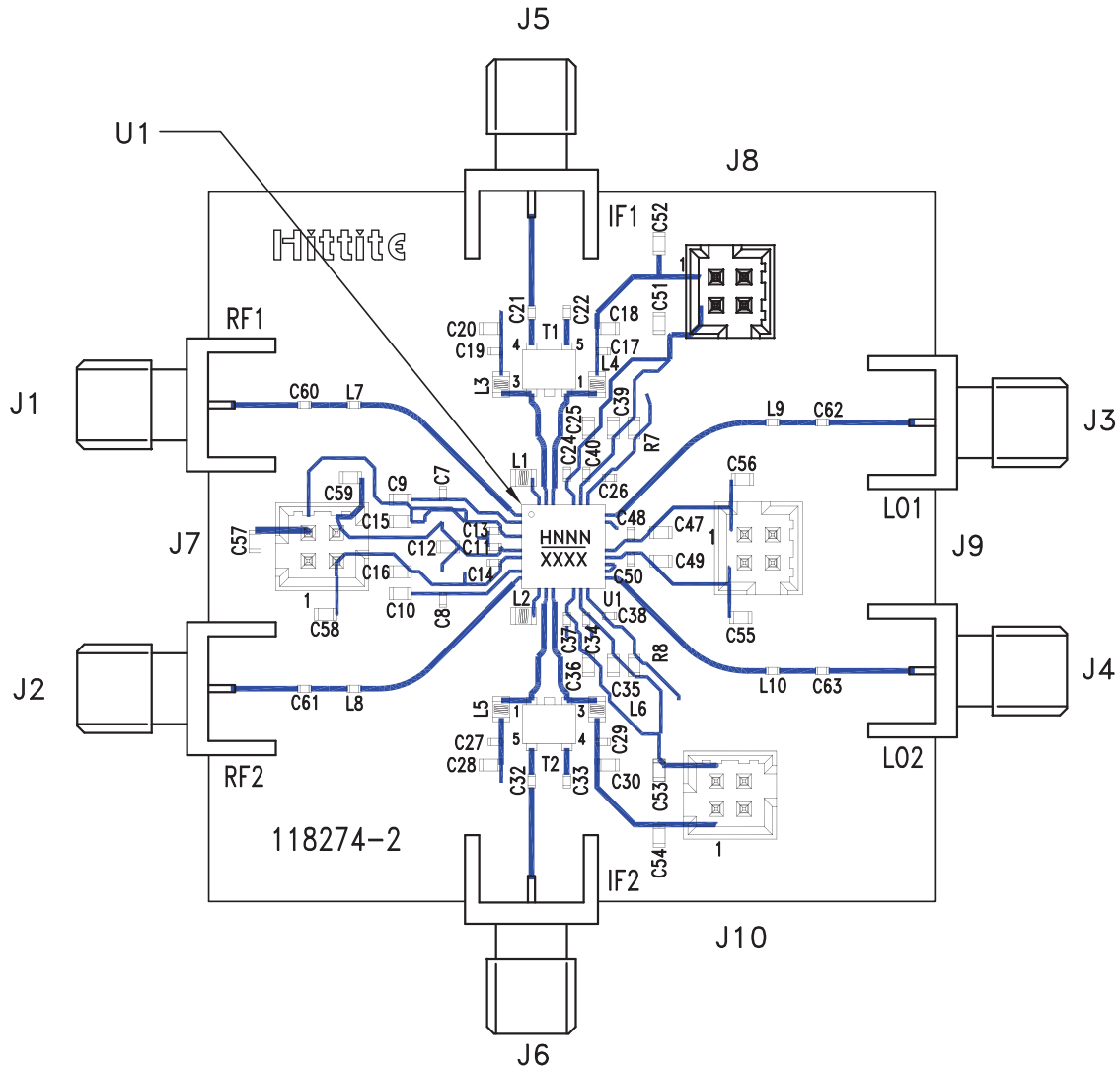

The circuit board used in the final application should use RF circuit design techniques. Signal lines should have 50 Ohm impedance while the package ground leads and exposed paddle should be connected directly to the ground plane similar to that shown. A sufficient number of via holes should be used to connect the top and bottom ground planes. The evaluation circuit board shown is available from Hittite upon request.

Information furnished by Analog Devices is believed to be accurate and reliable. However, no responsibility is assumed by Analog Devices for its use, nor for any infringements of patents or other rights of third parties that may result from its use. Specifications subject to change without notice. No license is granted by implication or otherwise under any patent or patent rights of Analog Devices. Trademarks and registered trademarks are the property of their respective owners.

For price, delivery, and to place orders: Analog Devices, Inc., One Technology Way, P.O. Box 9106, Norwood, MA 02062-9106 Phone: 781-329-4700 • Order online at www.analog.com Application Support: Phone: 1-800-ANALOG-D

**HIGH IP3 DUAL CHANNEL
DOWNCONVERTER w/ LO SWITCH, 0.7 - 1.0 GHz**
List of Materials for Evaluation PCB 119926 [1]

| Item | Description |
|---|-----------------------------------|
| J1 - J6 | PCB Mount SMA Connector |
| J7 - J10 | 2mm Vertical Molex 8pc Connector |
| L1, L2 | 51 nH Inductor, 0603 Pkg. |
| L3 - L6 | 390 nH Inductor, 0603 Pkg. |
| L7, L8 | 5.1 nH Inductor, 0402 Pkg. |
| L9, L10 | 3.6 nH Inductor, 0402 Pkg. |
| C7, C8, C26, C38 | 22 pF Capacitor, 0402 Pkg. |
| C9, C10 | 10 nF Capacitor, 0603 Pkg. |
| C11, C17, C19, C24, C27, C29, C34, C37, C40, C48, C50 | 1 nF Capacitor, 0402 Pkg. |
| C12, C15, C16, C18, C20, C25, C28, C30, C35, C36, C39, C47, C49 | 0.1 μ F Capacitor, 0603 Pkg. |
| C13, C14, C60 - C63 | 100 pF Capacitor, 0402 Pkg. |
| C21, C22, C32, C33 | 0.01 μ F Capacitor, 0402 Pkg. |
| C51 - C59 | 0.47 μ F Capacitor, 0603 Pkg. |
| R7, R8 | 330 Ohm Resistor, 0603 Pkg. |
| T1, T2 | 1:1 Transformer - Tyco ETC1-IT |
| U1 | HMC683LP6C(E) |
| PCB [2] | 118274 Evaluation PCB |

[1] Reference this number when ordering complete evaluation PCB

[2] Circuit Board Material: Arlon-25FR and FR4

**HIGH IP3 DUAL CHANNEL
DOWNCONVERTER w/ LO SWITCH, 0.7 - 1.0 GHz**



Application Circuit

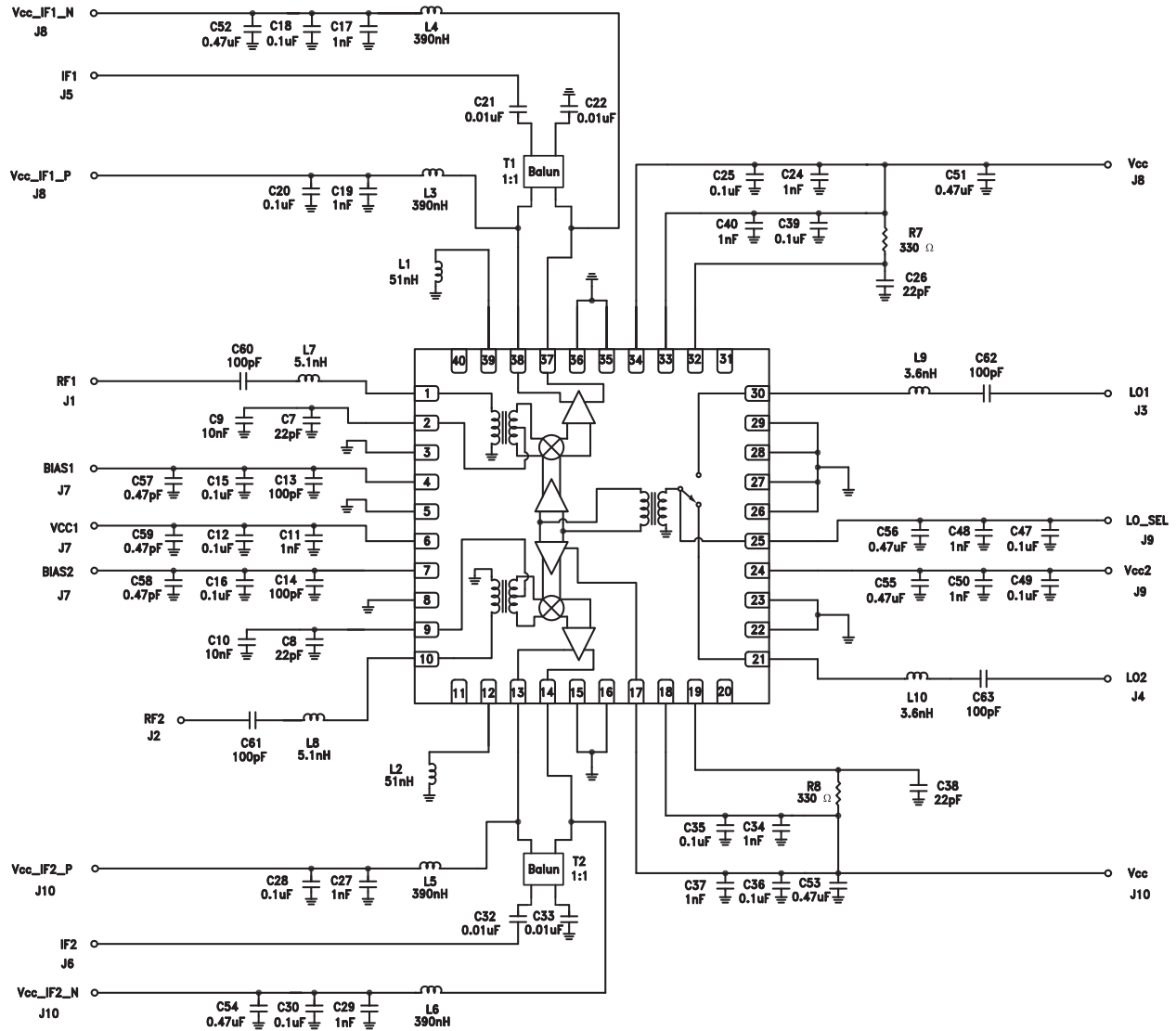

Information furnished by Analog Devices is believed to be accurate and reliable. However, no responsibility is assumed by Analog Devices for its use, nor for any infringements of patents or other rights of third parties that may result from its use. Specifications subject to change without notice. No license is granted by implication or otherwise under any patent or patent rights of Analog Devices. Trademarks and registered trademarks are the property of their respective owners.

For price, delivery, and to place orders: Analog Devices, Inc., One Technology Way, P.O. Box 9106, Norwood, MA 02062-9106 Phone: 781-329-4700 • Order online at www.analog.com Application Support: Phone: 1-800-ANALOG-D