

For FPC/FFC*	<h1>Y5B/Y5BW</h1>
FPC connectors (0.5mm pitch) Back lock	



Y5B/Y5BW

RoHS compliant

FEATURES

1. Low profile (height: 1.0 mm), space saving back lock type with improved lever operability.
2. Mechanical design freedom achieved by top and bottom double contacts.

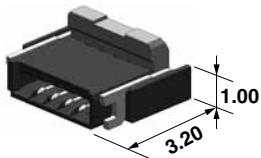

Unit: mm

4 pin contacts (Y5B: minimum)

3. FPC insertion displacement prevention

Constructed to make positional displacement difficult by surrounding the four sides on the FPC inlet side with wall molding

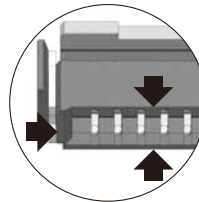

4. Wiring patterns can be placed underneath the connector.

5. Man-hours for assembly can be reduced by delivering the connectors with their levers opened.

6. Y5BW features lock holding type, including a structure to temporarily hold the FPC and a higher holding force.

The FPC holding contacts located on both ends of the connector facilitate positioning of FPC and further enhance the FPC holding force.

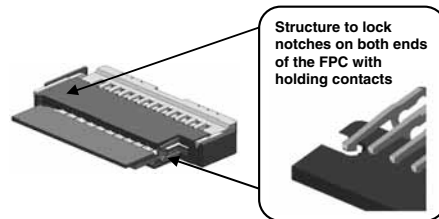

Applicable FPC shape



With notches

- (1) The inserted FPC can be temporarily held until the lever is closed.
- (2) When the lever is closed, the holding contacts lock the FPC by its notches, enhancing the FPC holding force.

* (Y5BW is compatible with FPC only.)

7. Supports V-by-One® HS.

APPLICATIONS

A wide range of digital equipment, including mobile phones, smartphones, PCs, digital still camera, and digital video camera. Ideal for touch panels and LCD backlights, which require connectors with a small number of pins.

*V-by-One®HS: An interface for the next-generation high-speed signals developed by THine Electronics, Inc.

V-by-One® is a registered trademark of THine Electronics, Inc.

ORDERING INFORMATION

Y5B

AYF 5 3 [] [] 3 5

53: FPC Connector Y5B (0.5 mm pitch)
Back lock

Number of pins (2 digits)

Function
3: Top and bottom double contacts

Surface treatment (Contact portion / Terminal portion)
5: Au plating/Au plating (Ni barrier)

Y5BW

AYF 5 3 [] [] 6 5 T

53: FPC Connector Y5BW (0.5 mm pitch)
Back lock

Number of pins (2 digits)

Function
6: Top and bottom double contacts, lock holding type

Surface treatment (Contact portion / Terminal portion)
5: Au plating/Au plating (Ni barrier)

T: Suction area expansion type

PRODUCT TYPES

Height	Y5B		Y5BW		Packing	
	Number of pins	Part number	Number of pins	Part number	Inner carton (1-reel)	Outer carton
1.0 mm	4	AYF530435	2	AYF530265T	5,000 pieces	10,000 pieces
	5	AYF530535	3	AYF530365T		
	6	AYF530635	4	AYF530465T		
	8	AYF530835	6	AYF530665T		
	10	AYF531035	8	AYF530865T		
	12	AYF531235	10	AYF531065T		
	14	AYF531435	12	AYF531265T		
	16	AYF531635	14	AYF531465T		
	24	AYF532435	22	AYF532265T		
	28	AYF532835	26	AYF532665T		
	30	AYF533035	28	AYF532865T		
	32	AYF533235	30	AYF533065T		
	34	AYF533435	32	AYF533265T		
	40	AYF534035	38	AYF533865T		
	42	AYF534235	40	AYF534065T		
50	AYF535035	48	AYF534865T			

- Notes: 1. Order unit;
 For volume production: 1-inner carton (1-reel) units
 For samples, please contact our sales office.
 2. Please contact our sales office for connectors having a number of pins other than those listed above.

SPECIFICATIONS

1. Characteristics

The followings show specifications, when using an applicable FPC (thickness 0.30 mm)

Item	Specifications	Conditions																			
Electrical characteristics	Rated current	0.5A/pin contact (Except for holding contact)																			
	Rated voltage	50V AC/DC																			
	Insulation resistance	Min. 1,000MΩ (initial)	Using 250V DC megger (applied for 1 min.)																		
	Dielectric strength	250V AC for 1 min.	No short-circuiting or damage at a detection current of 1 mA when the specified voltage is applied for one minute.																		
	Contact resistance	Max. 100mΩ	Based on the contact resistance measurement method specified by JIS C 5402.																		
Mechanical characteristics	FPC holding force	Y5B: Min. 0.2N/pin contact × pin contacts (initial) Y5BW: Min. 0.2N/pin contact × pin contacts + 2.0N (initial)	Measurement of the maximum force applied until the inserted compatible FPC is pulled out in the insertion axis direction while the connector lever is closed																		
Environmental characteristics	Ambient temperature	-55°C to +85°C	No icing or condensation.																		
	Storage temperature	-55°C to +85°C (product only) -40°C to +50°C (emboss packing)																			
	Thermal shock resistance (with FPC mated)	5 cycles, insulation resistance min. 100MΩ, contact resistance max. 100mΩ	Conformed to MIL-STD-202F, method 107G <table border="1"> <thead> <tr> <th>Order</th> <th>Temperature (°C)</th> <th>Time (minutes)</th> </tr> </thead> <tbody> <tr> <td>1</td> <td>-55$\frac{3}{3}$</td> <td>30</td> </tr> <tr> <td>2</td> <td>}</td> <td>Max. 5</td> </tr> <tr> <td>3</td> <td>85$\frac{3}{3}$</td> <td>30</td> </tr> <tr> <td>4</td> <td>}</td> <td>Max. 5</td> </tr> <tr> <td></td> <td>-55$\frac{3}{3}$</td> <td></td> </tr> </tbody> </table>	Order	Temperature (°C)	Time (minutes)	1	-55 $\frac{3}{3}$	30	2	}	Max. 5	3	85 $\frac{3}{3}$	30	4	}	Max. 5		-55 $\frac{3}{3}$	
	Order	Temperature (°C)	Time (minutes)																		
	1	-55 $\frac{3}{3}$	30																		
	2	}	Max. 5																		
	3	85 $\frac{3}{3}$	30																		
4	}	Max. 5																			
	-55 $\frac{3}{3}$																				
Humidity resistance (with FPC mated)	120 hours, insulation resistance min. 100MΩ, contact resistance max. 100mΩ	Conformed to IEC60068-2-78 Bath temperature 40°C±2°C, humidity 90% to 95% R.H.																			
Saltwater spray resistance (with FPC mated)	24 hours, insulation resistance min. 100MΩ, contact resistance max. 100mΩ	Conformed to IEC60068-2-11 Bath temperature 35°C±2°C, saltwater concentration 5%±1%																			
H ₂ S resistance (with FPC mated)	48 hours, contact resistance max. 100mΩ	Bath temperature 40°C±2°C, gas concentration 3 ppm ±1 ppm, humidity 75% to 80% R.H.																			
Soldering heat resistance	Peak temperature: 260°C or less 300°C within 5 sec. 350°C within 3 sec.	Reflow soldering Soldering iron																			
Lifetime characteristics	Insertion and removal life	20 times	Repeated insertion and removal: min. 10 sec./time																		
Unit weight	Y5B 50 pin contacts: 0.16 g																				

2. Material and surface treatment

Part name	Material	Surface treatment
Molded portion	Housing: LCP resin (UL94V-0) Lever: LCP resin (UL94V-0)	—
Contact	Copper alloy	Contact portion; Base: Ni plating, Surface: Au plating Terminal portion; Base: Ni plating, Surface: Au plating
Holding contact (Only Y5BW)	Copper alloy	Terminal portion; Base: Ni plating, Surface: Au plating
Soldering terminals	Copper alloy	Base: Ni plating, Surface: Au plating

DIMENSIONS (Unit: mm)

The CAD data of the products with a **CAD Data** mark can be downloaded from: <http://industrial.panasonic.com/ac/e/>

Y5B

CAD Data

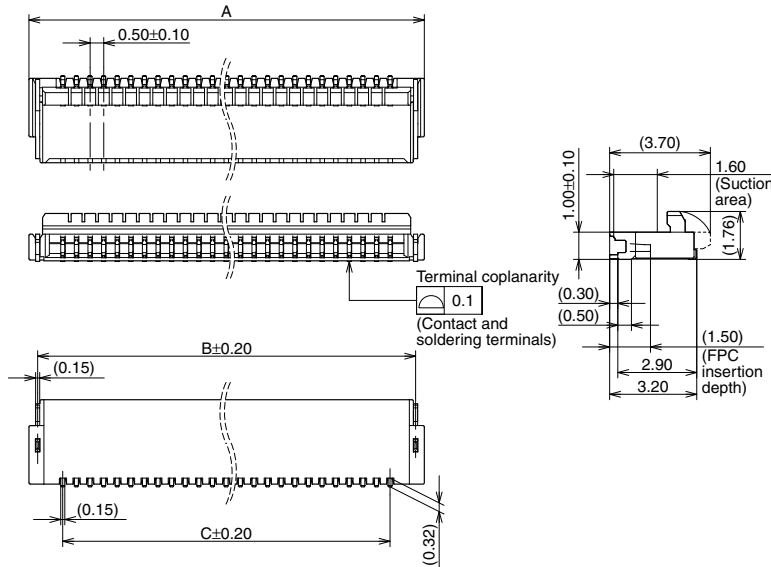

General tolerance: ± 0.3

Each mentioned dimension is at the stage of initial delivery.

Number of pins/ dimension	A	B	C
4	4.00	3.36	1.50
5	4.50	3.86	2.00
6	5.00	4.36	2.50
8	6.00	5.36	3.50
10	7.00	6.36	4.50
12	8.00	7.36	5.50
14	9.00	8.36	6.50
16	10.00	9.36	7.50
24	14.00	13.36	11.50
28	16.00	15.36	13.50
30	17.00	16.36	14.50
32	18.00	17.36	15.50
34	19.00	18.36	16.50
40	22.00	21.36	19.50
42	23.00	22.36	20.50
50	27.00	26.36	24.50

Y5B RECOMMENDED FPC/FFC DIMENSIONS

(Finished thickness: $t = 0.3 \pm 0.03$)

The conductive parts should be based by Ni plating and then Au plating.

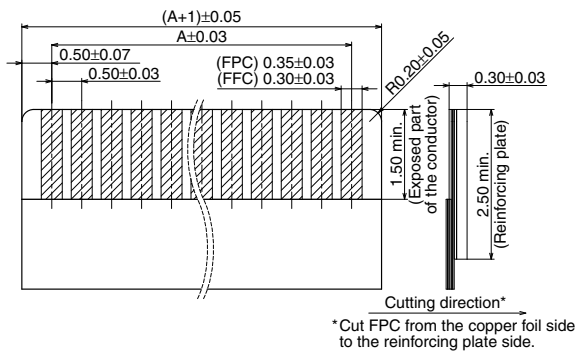

*Cut FPC from the copper foil side to the reinforcing plate side.

Number of pins/ dimension	A
4	1.50
5	2.00
6	2.50
8	3.50
10	4.50
12	5.50
14	6.50
16	7.50
24	11.50
28	13.50
30	14.50
32	15.50
34	16.50
40	19.50
42	20.50
50	24.50

Y5BW

CAD Data

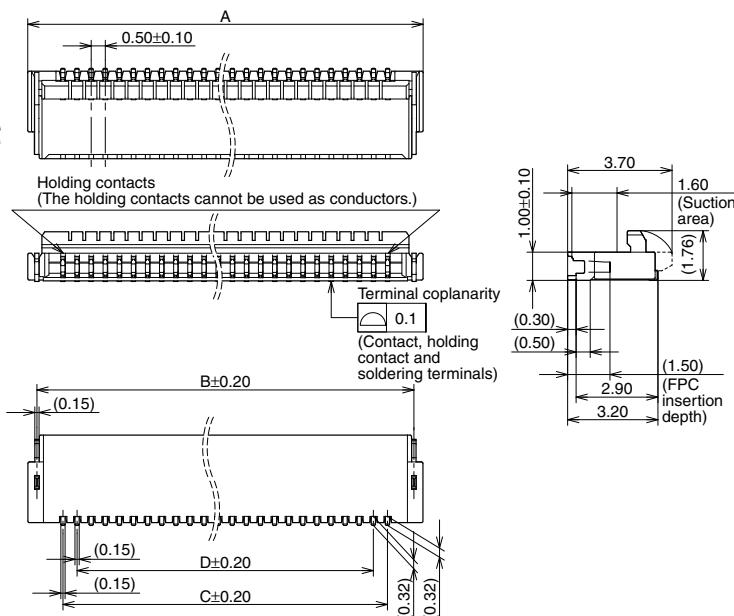

General tolerance: ± 0.3

Each mentioned dimension is at the stage of initial delivery.

Number of pins/ dimension	A	B	C	D
2	4.00	3.36	1.50	0.50
3	4.50	3.86	2.00	1.00
4	5.00	4.36	2.50	1.50
6	6.00	5.36	3.50	2.50
8	7.00	6.36	4.50	3.50
10	8.00	7.36	5.50	4.50
12	9.00	8.36	6.50	5.50
14	10.00	9.36	7.50	6.50
22	14.00	13.36	11.50	10.50
26	16.00	15.36	13.50	12.50
28	17.00	16.36	14.50	13.50
30	18.00	17.36	15.50	14.50
32	19.00	18.36	16.50	15.50
38	22.00	21.36	19.50	18.50
40	23.00	22.36	20.50	19.50
48	27.00	26.36	24.50	23.50

Y5BW RECOMMENDED FPC DIMENSIONS

(Finished thickness: $t = 0.3 \pm 0.03$)

The conductive parts should be based by Ni plating and then Au plating.

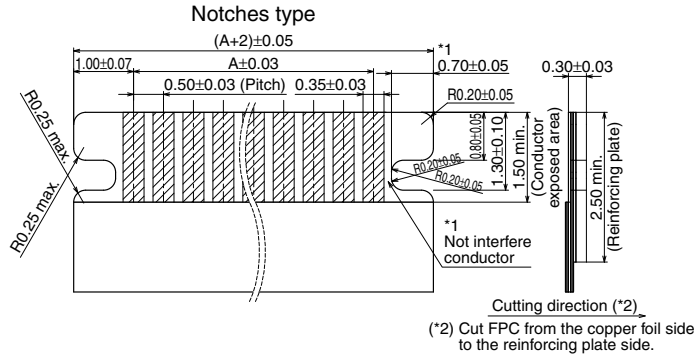

Number of pins/dimension	A
2	0.50
3	1.00
4	1.50
6	2.50
8	3.50
10	4.50
12	5.50
14	6.50
22	10.50
26	12.50
28	13.50
30	14.50
32	15.50
38	18.50
40	19.50
48	23.50

EMBOSSED TAPE DIMENSIONS (Unit: mm)

• Specifications for taping

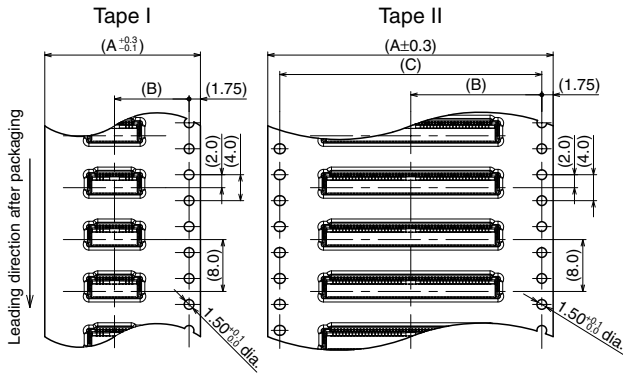

• Specifications for the plastic reel
 (In accordance with EIAJ ET-7200B.)

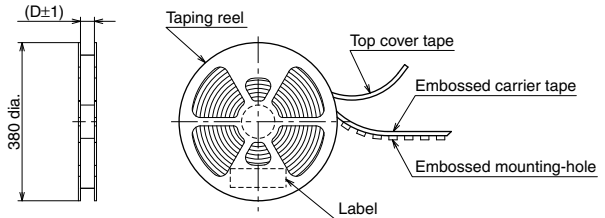

• Y5B Dimension table (Unit: mm)

Number of pins	Type of taping	A	B	C	D	Quantity per reel
4 to 10	Tape I	16.0	7.5	—	17.4	5,000
12 to 30	Tape I	24.0	11.5	—	25.4	5,000
32 to 34	Tape II	32.0	14.2	28.4	33.4	5,000
40 to 50	Tape II	44.0	20.2	40.4	45.4	5,000

• Y5BW Dimension table (Unit: mm)

Number of pins	Type of taping	A	B	C	D	Quantity per reel
2 to 8	Tape I	16.0	7.5	—	17.4	5,000
10 to 28	Tape I	24.0	11.5	—	25.4	5,000
30 to 32	Tape II	32.0	14.2	28.4	33.4	5,000
38 to 48	Tape II	44.0	20.2	40.4	45.4	5,000

• Connector orientation with respect to embossed tape feeding direction

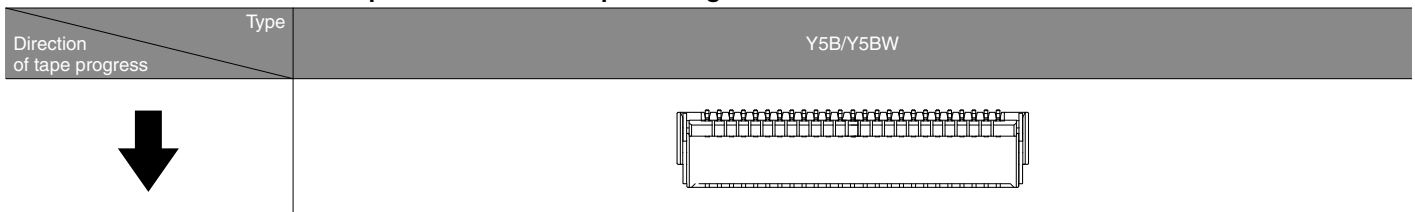

NOTES

1. Recommended PC board and metal mask patterns

Connectors are mounted with high pitch density, intervals of contact pitch 0.4 mm, 0.5 mm or 0.6 mm.

In order to reduce solder and flux rise, solder bridges and other issues make sure the proper levels of solder is used.

The figures to the right are recommended metal mask patterns. Please use our recommended patterns basically.

Please refer to the latest product specifications when designing your product.

• Y5B/Y5BW

Recommended PC board pattern
(mounting layout)
(TOP VIEW)

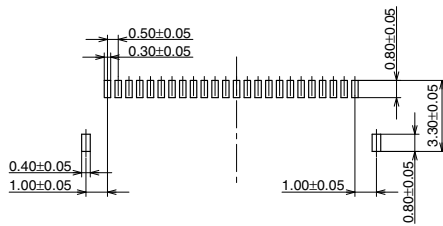

Recommended metal mask pattern

Metal mask thickness: When 120 μ m
(Terminal portion opening area ratio: 57%)
(Soldering terminal portion opening area ratio: 100%)

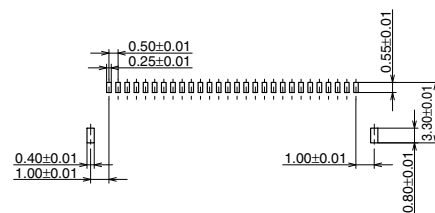

Notes on Using FPC Connectors

■ About safety Remarks

• Do not use these connectors beyond the specification sheets. The usage outside of specified rated current, dielectric strength, and environmental conditions and so on may cause circuitry damage via abnormal heating, smoke, and fire.

• In order to avoid accidents, your thorough specification review is appreciated.

Please contact us if your usage is out of the specifications.

Otherwise, Panasonic Corporation cannot guarantee the quality and reliability.

• Panasonic Corporation is consistently striving to improve quality and reliability.

However, the fact remains that electrical components and devices generally cause failures at a given statistical probability. Furthermore, their durability varies with use environments or use conditions. In this respect, please check for actual electrical components and devices under actual conditions before use. Continued usage in a state of degraded condition may cause the deteriorated insulation, thus result in abnormal heat, smoke or firing. Please carry out safety design and periodic maintenance including redundancy design, design for fire spread prevention, and design for malfunction prevention so that no accidents resulting in injury or death, fire accidents, or social damage will be caused as a result of failure of the products or ending life of the products.

■ PC board design

• Design the recommended foot pattern in order to secure the mechanical strength in the soldered areas of the terminal.

• In order to facilitate the connector mount, make sure to design the board with reduced warpage.

• Please design and pay attention to the distance from the board edge to the pattern. When cutting the board, do not give an excessive stress to the connector, which risks damaging the connector.

(Y3BW/Y5BW)

• Depending on FPC dimension and FPC insertion location, there is a possibility that the holding contact and an FPC pattern of both end of signal contacts are in short-circuited.

Please design the equipment not to be affected even if a board pattern of holding contacts and an FPC pattern of both end of signal contacts are in short-circuited.

(For example: Do not connect a board pattern of holding contacts and GND. If connect a board pattern of holding contacts and GND, also connect board pattern of both end of signal contacts.)

■ FPC and equipment design

• Design the FPC based with recommended dimensions to ensure the required connector performance.

• When back lock type is used, secure enough space for closing the lever and for open-close operation of the lever.

• Make sure that connector positioning and FPC length are appropriate to prevent diagonal insertion of the FPC.

• Due to the FPC size, weight, or the reaction force of the routed FPC, FPC removed and connector deformation may occur by a fall, vibration, or other impact.

When using FPC connector for smart phones, cellular phones and other applications which require falling resistance, please pay attention to precautions.

• Carefully check the equipment design and take required measures to prevent the FPC removed.

• If the shock of falling, vibration is applied to the FPC, please design the equipment not to be applied a load to connector, such as fixing the FPC.

• Make sure to design the FPC insertion part with reduced warpage. Otherwise, the warpage may adversely affect the FPC insertion.

(Y4BH)

When using in high-speed transmission applications, please take care when designing the FPC/FFC, because the differential impedance values may be uneven depending on FPC/FFC dimensions settings, uneven dimensions, and layering composition.

(Y3BW/Y5BW)

■ The holding contacts cannot be used as conductors.

The holding contacts are located on both ends of the connector, and the shape of the soldered portions is the same as that of the signal contacts.

Use caution to ensure connect identification.

(Y3BL)

■ Soldering terminal structure

• Since soldering terminals touch FPC, note that the short circuit may occur when the metal parts exposed on side of FPC.

• Depending on FPC dimension, there is a possibility that soldering terminals and an FPC pattern of both end of signal contacts are in short-circuited.

Please design the equipment not to be affected even if a board pattern of soldering terminals and an FPC pattern of both end of signal contacts are in short-circuited.

(For example: Do not connect a board pattern of soldering terminals and GND. If connect a board pattern of soldering terminals and GND, also connect board pattern of both end of signal contacts.)

■ Connector mounting

• Excessive moulder chucking force may deform the molded or metal part of the connector. Consult us in advance if chucking is to be applied.

• In case of dry condition, please note the occurrence of static electricity.

The product may be adhered to the embossed carrier tape or the cover tape in dry condition.

Recommended humidity is from 40%RH to 60%RH and please remove static electricity by ionizer in manufacturing process.

Notes on Using FPC Connectors

■ Soldering

1) Manual soldering

- As this product is compact size, please avoid the excessive solder. Because the excessive solder makes creepage and flux wicking at contact portion, or impact contact by soldering interference.
- Please use the soldering iron under specified temperature and times.
- Soldering flux may contaminate the contact portion, please check the contact portion after soldering with a magnifying glass. If the contamination is found, please clean the contamination before use.
- As excessive force to terminal by manual soldering has some possibilities of contact portion deformation, please be careful to the force by hand.
- Please clean soldering iron tip.
- Make sure that the soldering iron tip is heated within the temperature and time limits indicated in the specifications.
- Flux from the solder wire may adhere to the contact surfaces during soldering operations. After soldering, carefully check the contact surfaces and cleans off any flux solder use.
- Be aware that a load applied to the connector terminals while soldering may displace the contact.
- Thoroughly clean the iron tip.

2) Reflow soldering

- When cream solder printing is used, screen method is recommended.
- To achieve the appropriate soldering state, make sure that the reflow temperature, PC board foot pattern, window size and thickness of metal mask are recommended condition.
- Note that excess solder on the terminals prevents complete insertion of the FPC, and causes flux climbing up.
- A screen thickness of 120 μ m is recommended during cream solder printing.
- When applying the different thickness of a screen, please contact us.
- There may be a case of difficult self-alignment depending on the connector size. In that case, please be careful to align terminals and solder pads.
- The following diagram shows the recommended reflow soldering temperature profile.

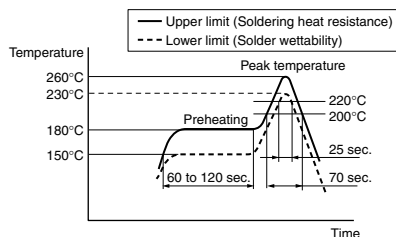

- Infrared reflow soldering is able to pass two times.
- The temperature is measured on the PC board surface near connector terminals.
- The condition of solder or flux creepage and wettability depend on the type of solder and flux. Please set the reflow temperature and oxygen level by considering the solder and flux characteristics.
- Do not use resin-containing solder. Otherwise, the contacts might be firmly fixed.
- When performing reflow soldering on the back of the PC board after reflow soldering the connector, secure the connector using, for example, an adhesive.
(Double reflow soldering on the same side is possible.)
Do not apply reflow heating while a lever is closing (or on the way of closing). The terminals may be deformed by reflow heating with a lever is closing (or on the way of closing).

3) Rework of soldering portion.

- Rework shall be only one time.
- Please avoid the supplementary flux in case of rework for soldering bridge, as this may cause flux creepage to contact portion.
When adding the solder for reworking, do not add an excessive solder.
- Please use the soldering iron under specified temperature.

■ **As the excessive force on the terminals may cause the deformation and the integrity of solderability will be lost during reflow soldering, please avoid dropping or rough handling of the product.**

■ **When the soldering is not completed, do not open/ close the lever or insert/ remove an FPC.**

And the external compulsory force to the terminal may cause the fixing force lowering between the terminal and the molding or the coplanarity failures. In addition, do not insert an FPC into the connector before soldering the connector.

■ **When cutting or bending the PC board after mounting the connector, please avoid the stress at the soldering portion.**

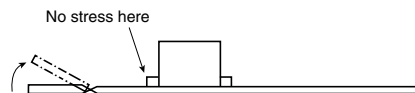

■ PC board

As thick coverlay / solder resist and adhesive may cause poor soldering, please set thickness of coverlay and adhesive as thin as possible.

■ Precautions for insertion/removal of FPC

(Except for Y3BC)

- Avoid touching the lever (applying any external force) until an FPC is inserted.

Do not open/close the lever without an FPC inserted. Failure to follow this instruction will cause the contacts to warp, leading to the contact tips to interfere with the insertion of an FPC, deforming the terminals. Failure to follow this instruction may cause the lever to be removed, terminals to be deformed, and/or the FPC insertion force to increase.

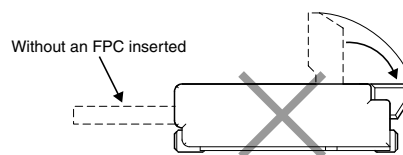

- These connectors are of the back lock type, which has the FPC insertion section on the opposite side of the lever. Be careful not to make a mistake in the FPC insertion position or the lever opening/closing position. Otherwise, a contact failure or connector breakage may occur.
- Do not insert an FPC upside down. Inserting an FPC in a direction opposite to that you intended may cause an operation failure or malfunction.
- Insert an FPC with the lever opened at right angle, that is, in the factory default position.

- After checking the position of FPC insertion slot and FPC, completely insert the FPC horizontally to the full depth of the connector without altering the angle. An FPC inserted at an excessive angle to the board may cause the deformation of metal parts, crack of molding parts, FPC insertion failures, and FPC circuit breakages.

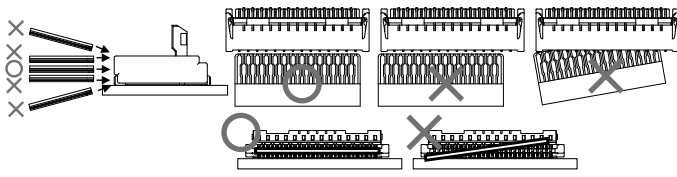

- Insert the FPC into the connector after checking the position of FPC insertion slot and FPC. Do not insert the FPC without positioning the FPC and connector. Otherwise, it may cause connector breakages. When it is hard to insert the FPC, do not insert the FPC on that condition. Confirm the FPC and connector positioning.
- Do not apply an excessive load to the lever in the opening direction beyond its open position; otherwise, the lever may be deformed or removed.
- Do not apply an excessive load to the lever in a direction perpendicular to the lever rotation axis or in the lever opening direction; otherwise, the terminals may be deformed, and the lever may be removed.

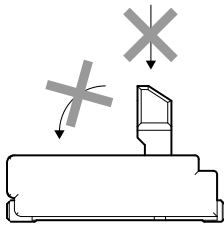

- To close the lever, turn down the lever by pressing the entire lever or both sides of the lever with fingers tips. And close the lever completely. Be careful not to apply partial load to the lever that may cause its deformation or destruction or lever going back to initial position. Close the lever completely to prevent contact failure.
- Avoid applying an excessive load to the top of the lever during or after closing the lever. Otherwise, the terminals may be deformed.
- When opening the lever to remove the FPC, rotate the lever to the initial position. Do not push the lever into the FPC inlet side and ensure that the lever will not go over the initial position; otherwise, it may be deformed or broken.
- To open the lever, if pressure to the lever is applied unevenly, such as to an edge only, it may deform or break.
- Do not open the lever forcefully with something sharp tool, otherwise, the lever may be deformed.
- Remove the FPC at parallel with the lever fully opened. If the lever is closed, or if the FPC is forcedly pulled, the product or FPC may break.
- If a lever is accidentally detached during the handling of a connector, do not use the connector any longer.

- After an FPC is inserted, carefully handle it so as not to apply excessive stress to the base of the FPC. When using FPC with a bent condition, please pay attention to precautions below; otherwise, in some conditions it may cause conduction failure, connector breakage, unlocking lever or FPC disconnection.

- Design so that a load is not applied to connector directly by FPC bending.
- Avoid sharp FPC bending at the root of FPC insertion part.
- Design so that a load is not applied to the part of FPC bending.
- If there might be a load on FPC, please fix the FPC.

(Y3BW and Y5BW)

- Fix the FPC if there might be a load to the cut out, do not apply bending load to the cutout part of FPC. Otherwise, it may cause FPC disconnection and deformation since the cutout part of FPC is subjected to bending stress.

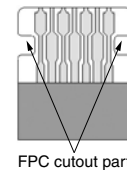

FPC cutout part

■ Cleaning treatment

Cleaning this product is not needed basically.

Please note the following points to prevent the negative effect to the product when cleaning is necessary.

- Please keep the cleanliness of the cleaning fluid to make sure that the contact surfaces are not contaminated by the cleaning fluid itself.
- Semi-aqueous cleaning solvent is recommended as some powerful solvent may dissolve the molding portion or the marked letters.

Please contact us when other solvent is used.

■ Precautions for operating environment and storage environment

Panasonic Corporation does not guarantee the failures caused by condensation.

■ Other precautions

- When the coating material is used for preventing PC board isolation deterioration after soldering, please assure the coating material is not adhered on any part of connector.
- Please avoid the usage of connector as electric switching basically.
- There is no problem on the product quality though the swelling, the black spot, the small scars and the foreign matter, etc. might be generated in the molding parts.
- There is no problem on the product quality though the weld line might be generated in the weld part of molding parts when the use of product is within the specifications.
- The detailed shape of metal parts and molding parts may differ depending on the mold.
- Height in FPC mating depends on the way to being used, such as mounting condition, thickness of FPC, and angle of lever lock etc. Please check it by actual equipment.

Please refer to the latest product specifications when designing your product.

Please contact

Panasonic Corporation

Electromechanical Control Business Division

■ 1006, Oaza Kadoma, Kadoma-shi, Osaka 571-8506, Japan
industrial.panasonic.com/ac/e/

Panasonic[®]

©Panasonic Corporation 2016

ACCTB1E 201602-T

Specifications are subject to change without notice.