

LTM4686B

Ultrathin Dual 14A or Single 28A μ Module Regulator With Digital Power System Management

DESCRIPTION

Demonstration circuit 3089A is a dual-output, high efficiency, high density, μ Module regulator with 2.7V to 5.75V input range. Each output can supply 14A maximum load current. The demo board has a [LTM4686B](#) μ Module regulator, which is a dual 14A or single 28A step-down regulator with digital power system management. Please see LTM4686B data sheet for more detailed information.

DC3089A powers up to default settings and produce power based on configuration resistors without the need for any serial bus communication. This allows easy evaluation of the DC/DC converter. To fully explore the extensive power system management features of the part, download the GUI software LTpowerPlay™ onto your PC and use LTC's I²C/SMBus/PMBus dongle DC1613A to connect to

the board. LTpowerPlay allows the user to reconfigure the part on the fly and store the configuration in EEPROM, view telemetry of voltage, current, temperature and fault status.

GUI Download

The software can be downloaded from: [ltpowerplay](#)

For more details and instructions of LTpowerPlay, please refer to LTpowerPlay GUI for LTM4686B Quick Start Guide.

[Design files for this circuit board are available.](#)

All registered trademarks and trademarks are the property of their respective owners.

BOARD PHOTO

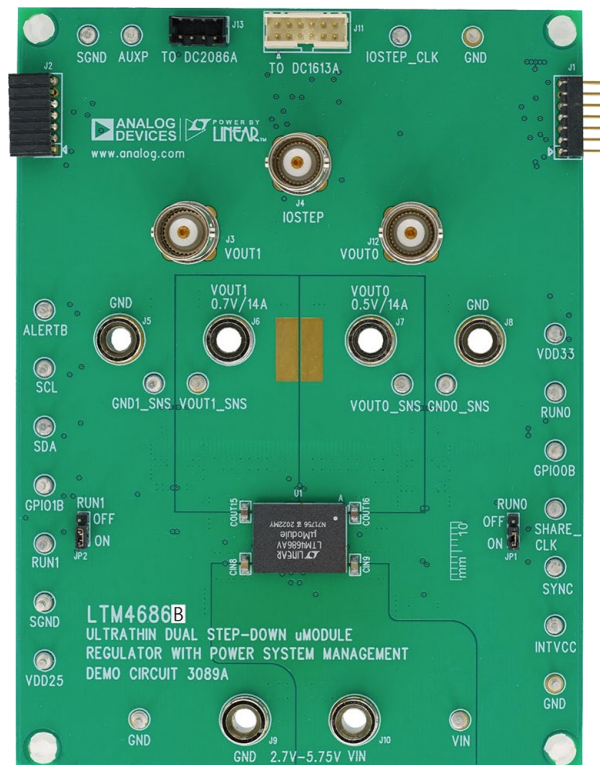

Figure 1. Dual-Output LTM4686B/DC3089A Demo Circuit

DEMO MANUAL DC3089A

PERFORMANCE SUMMARY Specifications are at $T_A = 25^\circ\text{C}$

PARAMETER	CONDITIONS	VALUE
Input Voltage Range		2.7V to 5.75V
Output Voltage, V_{OUT0}	$V_{IN} = 2.7\text{-}5.75\text{V}$, $I_{OUT0} = 0\text{A to }14\text{A}$	0.5V to 3.6V, Default: 0.5V
Maximum Output Current, I_{OUT0}	$V_{IN} = 2.7\text{-}5.75\text{V}$, $V_{OUT0} = 0.5\text{V to }3.6\text{V}$	14A
Output Voltage, V_{OUT1}	$V_{IN} = 2.7\text{-}5.75\text{V}$, $I_{OUT1} = 0\text{A to }14\text{A}$	0.5V to 3.6V, Default: 0.7V
Maximum Output Current, I_{OUT1}	$V_{IN} = 2.7\text{-}5.75\text{V}$, $V_{OUT1} = 0.5\text{V to }3.6\text{V}$	14A
Typical Efficiency	$V_{IN} = 5\text{V}$, $V_{OUT0} = 0.5\text{V}$, $I_{OUT0} = 14\text{A}$	73.5% (See Figure 5)
	$V_{IN} = 5\text{V}$, $V_{OUT1} = 0.7\text{V}$, $I_{OUT1} = 14\text{A}$	78.2% (See Figure 6)
Default Switching Frequency		650kHz

QUICK START PROCEDURE

Demonstration circuit 3089A is easy to set up to evaluate the performance of the LTM4686B. Refer to Figure 2 for the proper measurement equipment setup and follow the procedure below.

1. With power off, connect the input power supply to V_{IN} (2.7V-5.75V*) and GND (input return).
2. Connect the 0.5V output load between V_{OUT0} and GND (Initial load: no load).
3. Connect the 0.7V output load between V_{OUT1} and GND (Initial load: no load).
4. Connect the DVMs to the input and outputs. Set default jumper position: JP1: ON; JP2: ON.
5. Turn on the input power supply and check for the proper output voltages. V_{OUT0} should be $0.5V \pm 0.5\%$, and V_{OUT1} should be $0.7V \pm 0.5\%$.
6. Once the proper output voltages are established, adjust the loads within the operating range and observe the output voltage regulation, ripple voltage and other parameters.
7. Connect the dongle and control the output voltages from the GUI. See "LTpowerPlay GUI for the LTM4686B Quick Start Guide" for details.

Note: When measuring the output or input voltage ripple, do not use the long ground lead on the oscilloscope probe. See Figure 3 for the proper scope probe technique. Short, stiff leads need to be soldered to the (+) and (-) terminals of an output capacitor. The probe's ground ring needs to touch the (-) lead and the probe tip needs to touch the (+) lead.

-
- *
– If $2.70V < V_{IN} < 5.50V$,
R9=OPEN, R91=R92=0ohm
– If $4.50V < V_{IN} < 5.75V$,
R9=0ohm, R91=R92=OPEN
-

QUICK START PROCEDURE

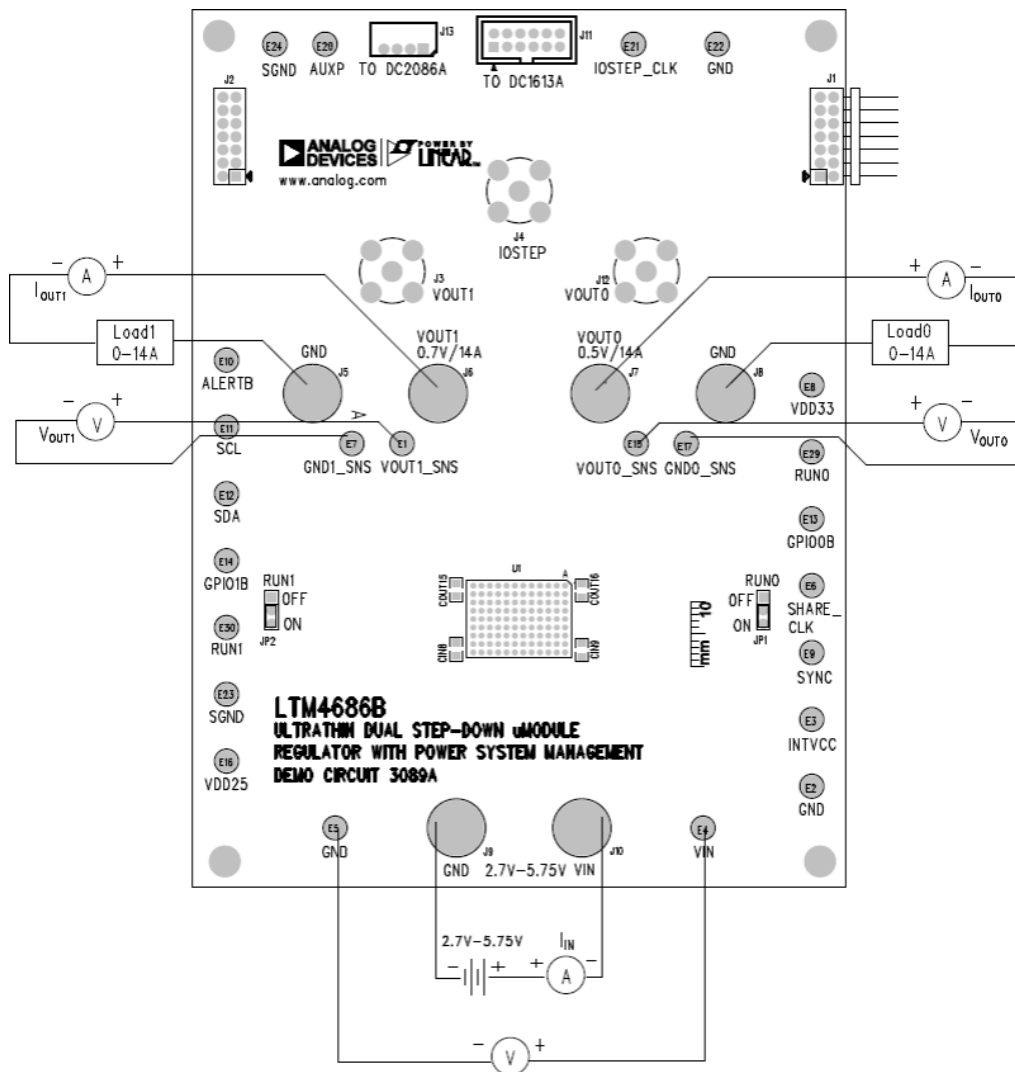

Figure 2. Proper Measurement Equipment Setup

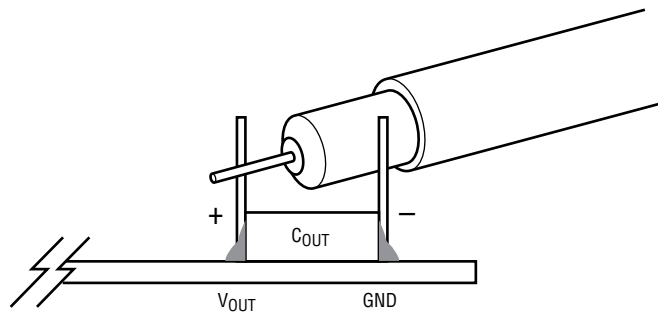

Figure 3. Measuring Output Voltage Ripple

QUICK START PROCEDURE

Connecting a PC to DC3089A

You can use a PC to reconfigure the power management features of the LTM4686B such as: nominal V_{OUT} , margin set points, OV/UV limits, temperature fault limits,

sequencing parameters, the fault log, fault responses, GPIOs and other functionalities. The DC1613A dongle may be plugged when V_{IN} is present.

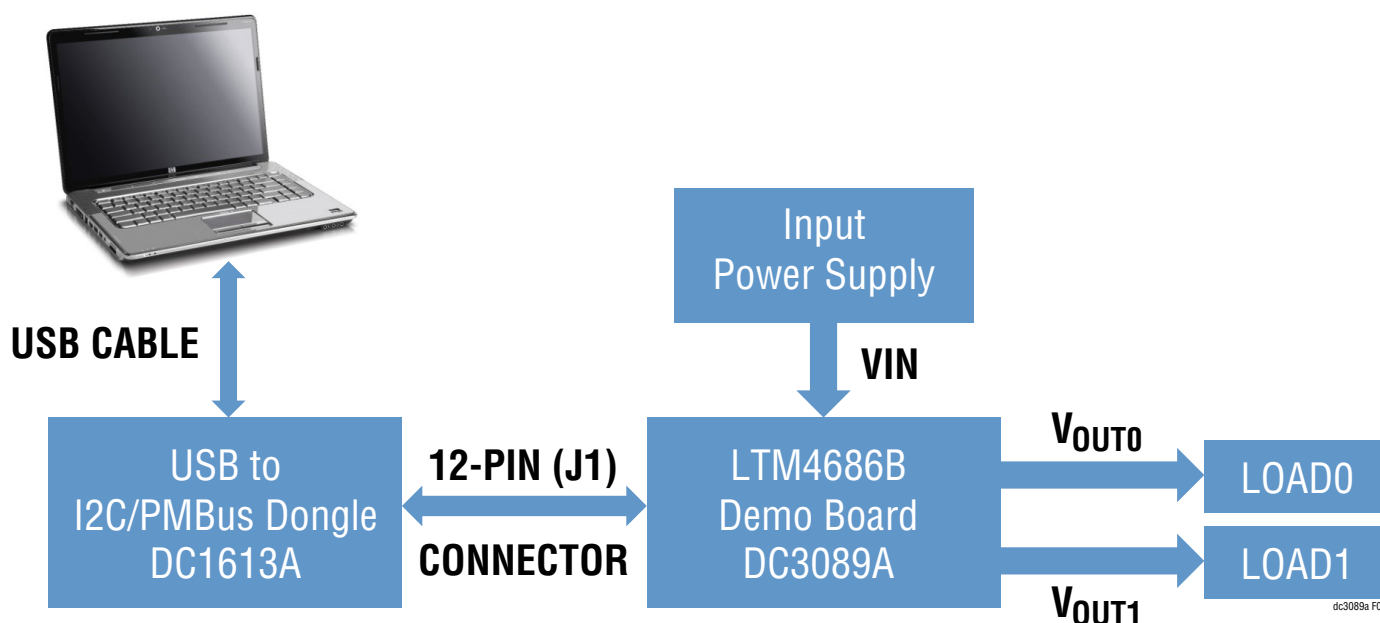

Figure 4. Demo Setup with PC

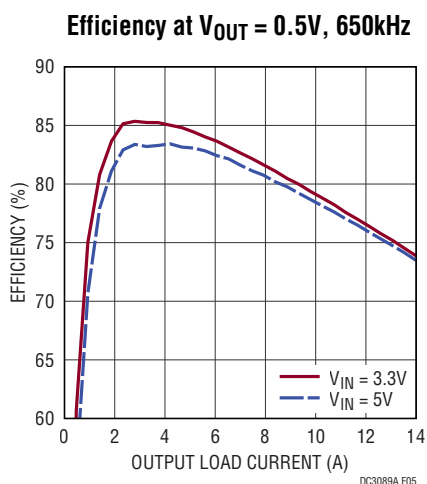

Figure 5. Efficiency vs Load Current on CH0

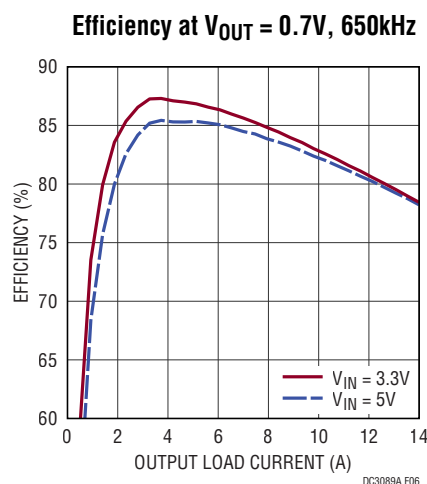

Figure 6. Efficiency vs Load Current on CH1

QUICK START PROCEDURE

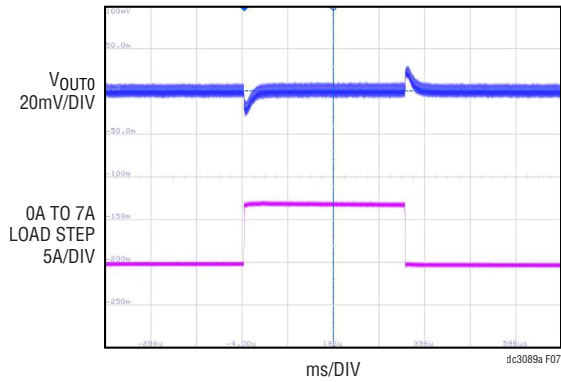

Figure 7. Output Voltage V_{OUT0} vs Load Current ($V_{OUT0} = 0.5V$)

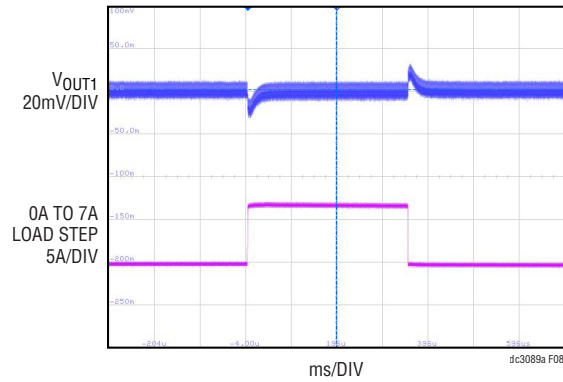

Figure 8. Output Voltage V_{OUT1} vs Load Current ($V_{OUT1} = 0.7V$)

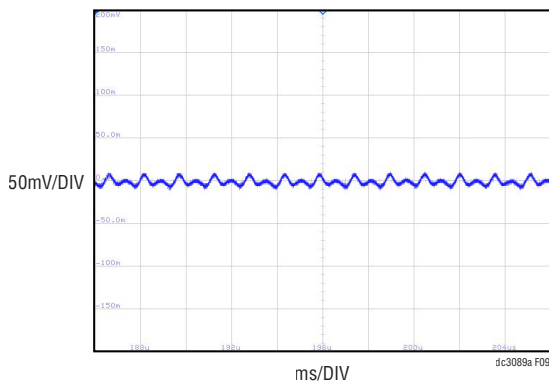

Figure 9. Output Voltage Ripple at $V_{IN} = 3.3V$, $V_{OUT0} = 0.5V$, $I_{OUT0} = 14A$

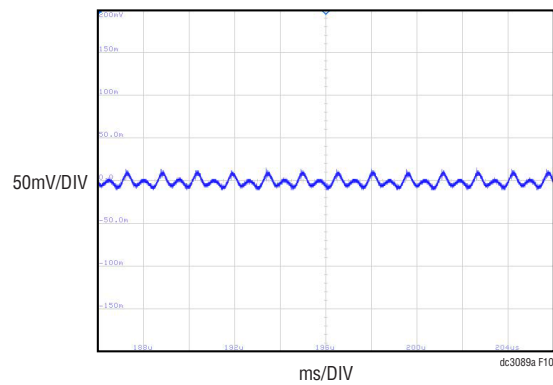

Figure 10. Output Voltage Ripple at $V_{IN} = 3.3V$, $V_{OUT1} = 0.7V$, $I_{OUT1} = 14A$

QUICK START PROCEDURE

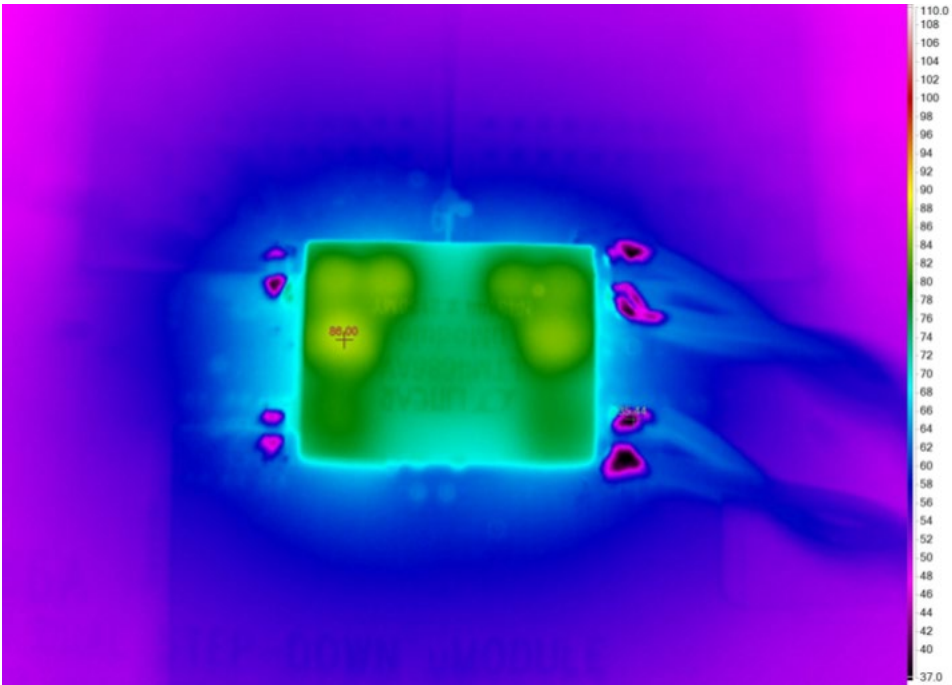

Figure 11. Thermal at $V_{IN} = 3.3V$, $V_{OUT0} = 0.5V$, $I_{OUT0} = 14A$, $V_{OUT1} = 0.7V$, $I_{OUT1} = 14A$, $T_A = 25^{\circ}C$, No Airflow

LTPowerPLAY SOFTWARE GUI

LTPowerPlay is a powerful Windows based development environment that supports Linear Technology power system management ICs and μ Modules, including the LTM4675, LTM4676A, LTM4677, LTM4678, LTM4686, LTC3880, LTC3882 and LTC3883. The software supports a variety of different tasks. You can use LTPowerPlay to evaluate Linear Technology ICs by connecting to a demo board system. LTPowerPlay can also be used in an offline mode (with no hardware present) in order to build a multichip configuration file that can be saved and reloaded at a later time. LTPowerPlay provides unprecedented diagnostic and debug features. It becomes a valuable diagnostic tool during board bring-up to program or tweak the power management scheme in a system, or to diag-

nose power issues when bringing up rails. LTPowerPlay utilizes the DC1613A USB-to-SMBus controller to communicate with one of many potential targets, including the LTM4675, LTM4676A, LTM4677, LTM4686, LTC3880, LTC3882, LTC3883's demo system, or a customer board. The software also provides an automatic update feature to keep the software current with the latest set of device drivers and documentation. The LTPowerPlay software can be downloaded from: ltpowerplay

To access technical support documents for LTC Digital Power Products visit the LTPowerPlay Help menu. Online help also available through the LTPowerPlay.

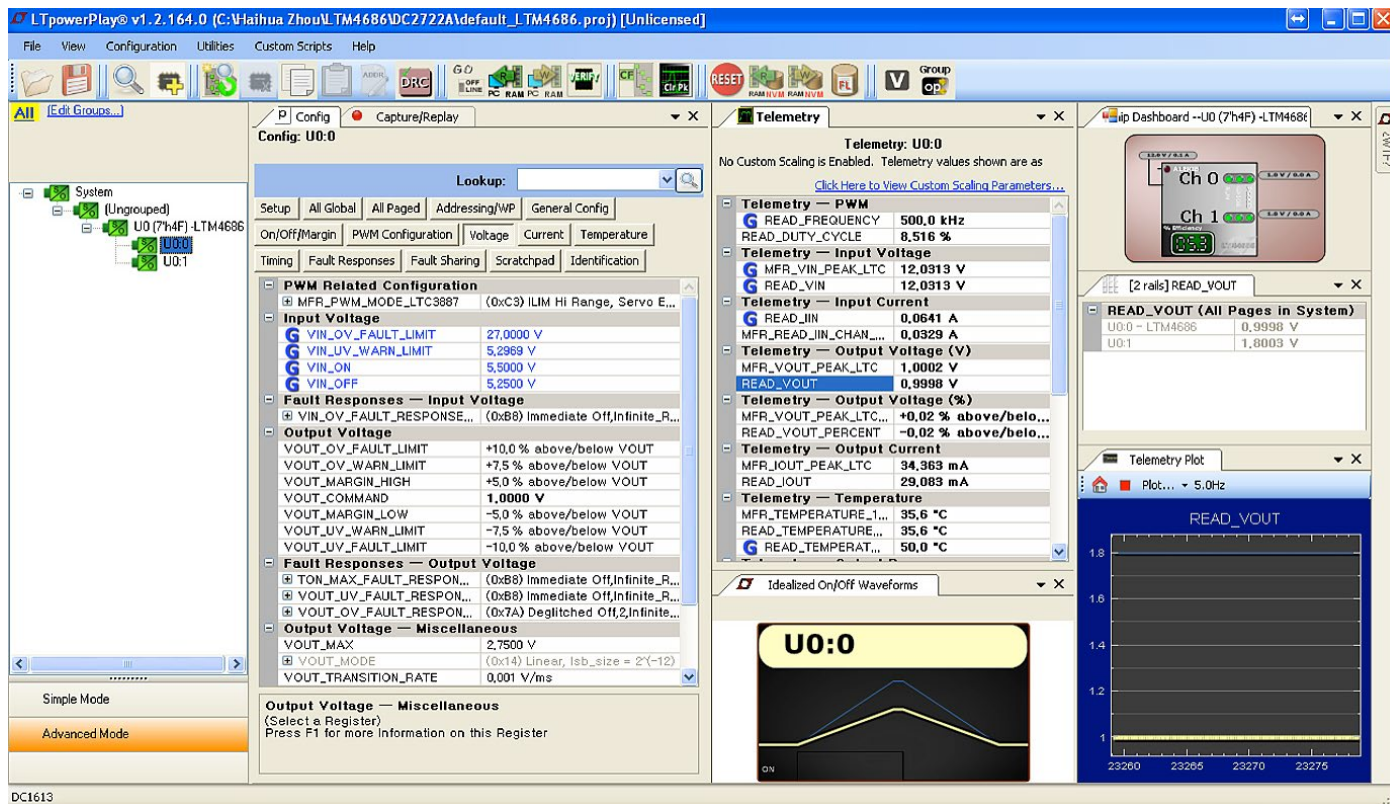

Figure 12. LTPowerPlay Main Interface

LTPowerPLAY QUICK START PROCEDURE

The following procedure describes how to use LTpower-Play to monitor and change the settings of LTM4686B.

1. Download and install the LTPowerPlay GUI:

[ltpowerplay](http://ltpowerplay.com)

2. Launch the LTpowerPlay GUI.

- a. The GUI should automatically identify the DC3089A. The system tree on the left-hand side should look like this:



- b. A green message box shows for a few seconds in the lower left hand corner, confirming that LTM4686B is communicating:

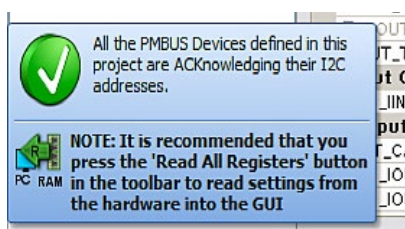

- c. In the Toolbar, click the “R” (RAM to PC) icon to read the RAM from the LTM4686B. This reads the configuration from the RAM of LTM4686B and loads it into the GUI.



- d. If you want to change the output voltage to a different value, like 0.6V. In the Config tab, type in 0.6 in the VOUT_COMMAND box, like this:

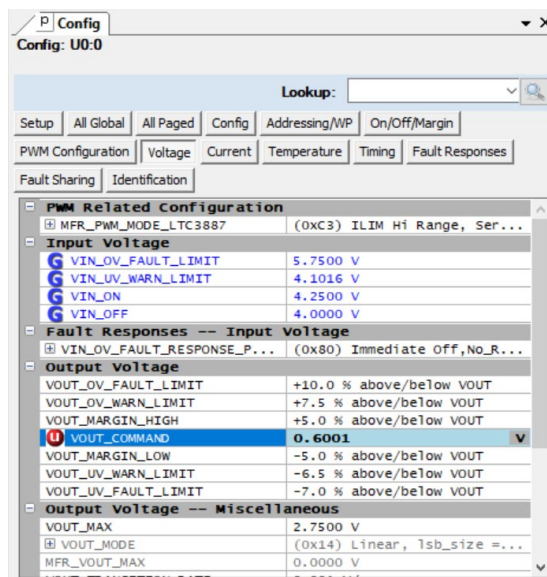

Then, click the “W” (PC to RAM) icon to write these register values to the LTM4686B. After finishing this step, you will see the output voltage will change to 0.6V.



If the write is successful, you will see the following message:



- e. You can save the changes into the NVM. In the tool bar, click “RAM to NVM” button, as following:



- f. Save the demo board configuration to a (*.proj) file. Click the Save icon and save the file. Name it whatever you want.

DEMO MANUAL DC3089A

PARTS LIST

ITEM	QTY	REFERENCE	PART DESCRIPTION	MANUFACTURER, PART NUMBER
Required Circuit Components				
1	1	C1N1	CAP, 150µF, ALUM. ELECT., 35V, 20%, 8x10.2mm SMD, RADIAL, AEC-Q200	PANASONIC, EEHZA1V151P
2	0	C16, C17	CAP, OPTION, 0603	
3	2	C2, C15	CAP, 100pF, COG, 25V, 5%, 0603	KEMET, C0603X101J3GCAUTO VISHAY, VJ0603A101JXXPW1BC AVX, 06033U101JAT2A
4	6	COUT1, COUT2, COUT3, COUT6, COUT7, COUT8	CAP, 100µF, X5R, 6.3V, 20%, 1206	AVX, 12066D107MAT2A KEMET, C1206C107M9PAC7800 KEMET, C1206C107M9PACTU MURATA, GRM31CR60J107ME39L NIC, NMC1206X5R107M6.3TRPLPF TDK, C3216X5R0J107M160AB
5	2	C1, C14	CAP, 1500pF, X7R, 100V, 10%, 0603	AVX, 06031C152KAT2A WURTH, 885012206109
6	4	CIN2, CIN3, CIN4, CIN5	CAP, 22µF, X5R, 25V, 10%, 1206	AVX, 12063D226KAT2A MURATA, GRM31CR61E226KE15L SAMSUNG, CL31A226KAHNNNE YAGEO, CC1206KKX5R8BB226
7	8	COUT4, COUT5, COUT9, COUT10, COUT11, COUT12, COUT13, COUT14	CAP, 180µF, ALUM POLY, 4V, 20%, SMD, 7.3x4.3mm	PANASONIC, EEF-CT0G181R PANASONIC, EEFC0G181R
8	2	CIN8, CIN9	CAP, 2.2µF, X7R, 25V, 10%, 0805	AVX, 08053C225KAT2A KEMET, C0805C225K3RACTU NIC, NMC0805X7R225K25TRPLPF TDK, C2012X7R1V225K125AE
9	2	COUT15, COUT16	CAP, 47µF, X5R, 6.3V, 20%, 0805	AVX, 08056D476KAT2A MURATA, GRM219R60J476ME44
10	3	C21, C22, C24	CAP, 1µF, X5R, 25V, 10%, 0603	AVX, 06033D105KAT2A NIC, NMC0603X5R105K25TRPF TAIYO YUDEN, TMK107BJ105KA-T
11	1	C23	CAP, 1µF, X7R, 25V, 10%, 0805	AVX, 08053C105KAT2A WURTH, 885012207078
12	1	C26	CAP, 0.1µF, X5R, 25V, 10%, 0603	AVX, 06033D104KAT2A SAMSUNG, CL10A104KA8NNNC TAIYO YUDEN, TMK107BJ104KA-T
13	2	C27, C28	CAP, 0.01µF, X5R, 25V, 10%, 0603	AVX, 06033D103KAT2A TDK, C1608X7R1E103K080AA
14	2	C29, C30	CAP, 4.7µF, X5R, 16V, 10%, 0603	AVX, 0603YD475KAT2A MURATA, GRM188R61C475KAAJD MURATA, GRM188R61C475KE11D TDK, C1608X5R1C475K080AC
15	1	C31	CAP, 2.2µF, X7R, 10V, 10%, 0603	AVX, 0603ZC225KAT2A MURATA, GRM188R71A225KE15D TDK, C1608X7R1A225K080AC YAGEO, CC0603KRX7R6BB225
16	0	D1, D2	DIODE, OPTION, SOD-323	
17	1	D8	DIODE, SCHOTTKY, 20V, 0.5A, SOD-882, LEADLESS	NEXPERIA, PMEG2005AEL, 315

PARTS LIST

ITEM	QTY	REFERENCE	PART DESCRIPTION	MANUFACTURER, PART NUMBER
18	24	E1, E2, E3, E4, E5, E6, E7, E8, E9, E10, E11, E12, E13, E14, E15, E16, E17, E20, E21, E22, E23, E24, E29, E30	TEST POINT, TURRET, 0.064 MTG. HOLE, PCB 0.062 THK	MILL-MAX, 2308-2-00-80-00-00-07-0
19	1	J1	CONN., HDR, MALE, 2x7, 2mm, R, A THT	MOLEX, 0877601416 MOLEX, 87760-1416
20	2	JP1, JP2	CONN., HDR., MALE, 1x3, 2mm, VERT, ST, THT	SULLINS CONNECTOR SOLUTIONS, NRPN031PAEN-RC
21	1	J2	CONN., HDR, FEMALE, 2x7, 2mm, R, A THT	SULLINS CONNECTOR SOLUTIONS, NPPN072FJFN-RC
22	3	J3, J4, J12	CONN., RF, BNC, RCPT, JACK, 5-PIN, ST, THT, 50Ω	AMPHENOL RF, 112404
23	6	J5, J6, J7, J8, J9, J10	CONN., BANANA JACK, FEMALE, THT, NON-INSULATED, SWAGE, 0.218	KEYSTONE, 575-4
24	1	J11	CONN., HDR, SHROUDED, MALE, 2x6, 2mm, VERT, ST, THT	AMPHENOL, 98414-G06-12ULF FCI, 98414-G06-12ULF
25	1	J13	CONN., HDR, SHROUDED, MALE, 1x4, 2mm, VERT, ST, THT	HIROSE ELECTRIC, DF3A-4P-2DSA
26	1	LB1	LABEL SPEC, DEMO BOARD SERIAL NUMBER	BRADY, THT-96-717-10
27	4	MH1, MH2, MH3, MH4	STANDOFF, NYLON, SNAP-ON, 0.50	KEYSTONE, 8833
28	1	PCB	PCB, DC3089A	ADI APPROVED SUPPLIER, 600-DC3089A
29	1	Q1	XSTR., MOSFET, N-CH, 40V, 14A, DPAK (TO-252)	VISHAY, SUD50N04-8M8P-4GE3
30	1	Q19	XSTR., MOSFET, P-CH, 30V, 3.5A, SOT23-3, AEC-Q101	DIODES INC., DMP3130LQ-7
31	2	R2, R22	RES., 7.5k, 1%, 1, 10W, 0603	VISHAY, CRCW06037K5FKEA
32	13	R3, R5, R7, R8, R25, R28, R32, R63, R65, R66, R91, R92, R93	RES., 0Ω, 1, 10W, 0603, AEC-Q200	NIC, NRC06ZOTRF VISHAY, CRCW06030000Z0EA VISHAY, CRCW06030000Z0EB
33	0	R6, R9, R23, R26, R28, R29, R31, R35, R38, R41, R42, R61, R62, R64, R67, R68, R74, R75, R83, R88, R89	RES., OPTION, 0603	
34	12	R10, R11, R12, R13, R14, R15, R16, R18, R19, R24, R52, R77	RES., 10k, 1%, 1, 10W, 0603, AEC-Q200	KOA SPEER, RK73H1JTTD1002F PANASONIC, ERJ3EKF1002V VISHAY, CRCW060310K0FKEA
35	1	R27	RES., 12.7k, 1%, 1, 10W, 0603	VISHAY, CRCW060312K7FKEA
38	1	R30	RES., 0.787k, 1%, 1, 10W, 0603, AEC-Q200	NIC., NRC06F7870TRF
39	1	R48	RES., 0Ω, 3, 4W, 2010, AEC-Q200	NIC, NRC50ZOTRF PANASONIC, ERJ12ZY0R00U VISHAY, CRCW20100000Z0EF
40	0	R49	RES., OPTION, 2010	
41	0	R50, R51	RES., OPTION, 300Ω, 1%, 2512	

DEMO MANUAL DC3089A

PARTS LIST

ITEM	QTY	REFERENCE	PART DESCRIPTION	MANUFACTURER, PART NUMBER
42	1	R53	RES., 0.01 Ω , 1%, 1W, 2010, SENSE	IRC, LRC-LRF2010LF-01-R010-F TT ELECTRONICS, LRC-LRF2010LF-01-R010-F
43	2	R72, R73	RES., 4.99k, 1%, 1, 10W, 0603, AEC-Q200	NIC, NRC06F4991TRF PANASONIC, ERJ3EKF4991V VISHAY, CRCW06034K99FKEA
44	1	R78	RES., 15.8k, 1%, 1, 10W, 0603, AEC-Q200	NIC, NRC06F1582TRF PANASONIC, ERJ3EKF1582V VISHAY, CRCW060315K8FKEA
45	2	R69, R70	RES., 10 Ω , 1%, 1, 1/10W, 0603	NIC, NRC06F10R0TRF PANASONIC, ERJ3EKF10R0V VISHAY, CRCW060310R0FKEA
46	0	R82	RES., OPTION, 1206	
47	2	STNCL1	TOOL, STENCIL, 700-DC3089A	ADI APPROVED SUPPLIER, 830-DC3089A
48	1	U1	IC, DUAL 10A OUTPUTS STEP-DOWN, μ Module REGULATOR, BGA	ANALOG DEVICES, LTM4685EV#PBF
49	1	U3	IC, MEMORY, EEPROM, 2Kb (256x8), TSSOP-8, 400kHz	MICROCHIP, 24LC025-I, ST MICROCHIP, 24LC025T-I, ST
50	1	U6	IC, LOW NOISE REGULATED CHARGE, PUMP IN, 2x2 DFN	ANALOG DEVICES, LTC3204BEDC-5#PBF
51	2	XJP1, XJP2	CONN., SHUNT, FEMALE, 2-POS, 2mm	SAMTEC, 2SN-BK-G

SCHEMATIC DIAGRAM

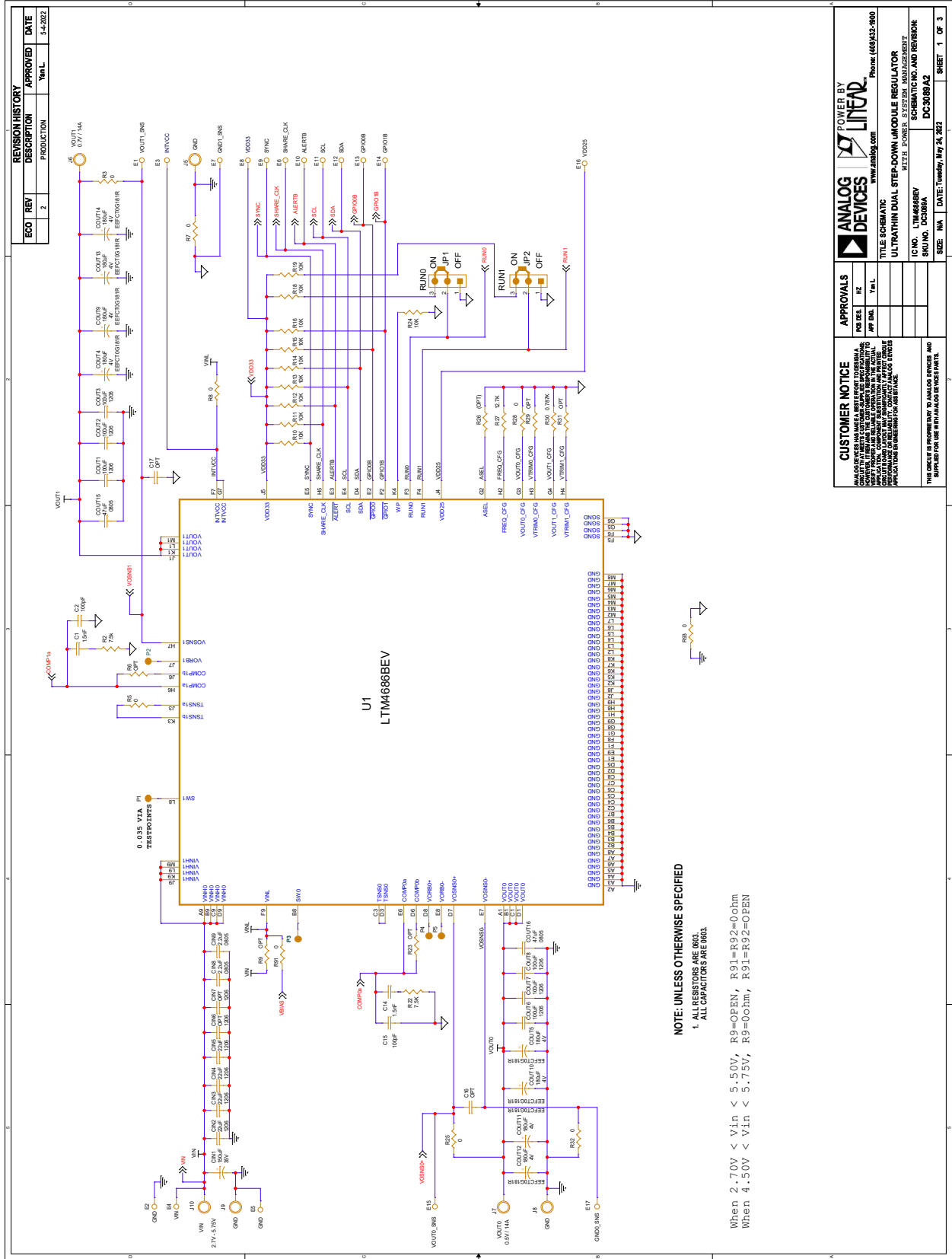

REVISION HISTORY			
ECO	REV	DESCRIPTION	DATE
	2	PRODUCTION	5-4-2012

APPROVALS		ANALOG DEVICES		POWER BY LINEAR	
NO. DATE	BY	NO. DATE	BY	NO. DATE	BY

CUSTOMER NOTICE
 THIS CIRCUIT IS PROVIDED AS A DESIGN EXAMPLE ONLY. THE USER ASSUMES ALL RESPONSIBILITY FOR THE DESIGN AND IMPLEMENTATION OF THE CIRCUIT. ANALOG DEVICES DOES NOT WARRANT THE PERFORMANCE OF THIS CIRCUIT IN ANY APPLICATION. APPLICATION ENGINEERING FOR ASSISTANCE.

TITLE SCHEMATIC
IC NO. LTM4688BEV
SKU NO. DC3089A
DATE Tuesday, May 24, 2012
SIZE 11A
SHEET 1 OF 3

NOTE: UNLESS OTHERWISE SPECIFIED
 1. ALL RESISTORS ARE 0603.
 ALL CAPACITORS ARE 0603.

When 2.70V < Vin < 5.50V, R9=OPEN, R91=R92=0ohm
 When 4.50V < Vin < 5.75V, R9=0ohm, R91=R92=OPEN

SCHEMATIC DIAGRAM

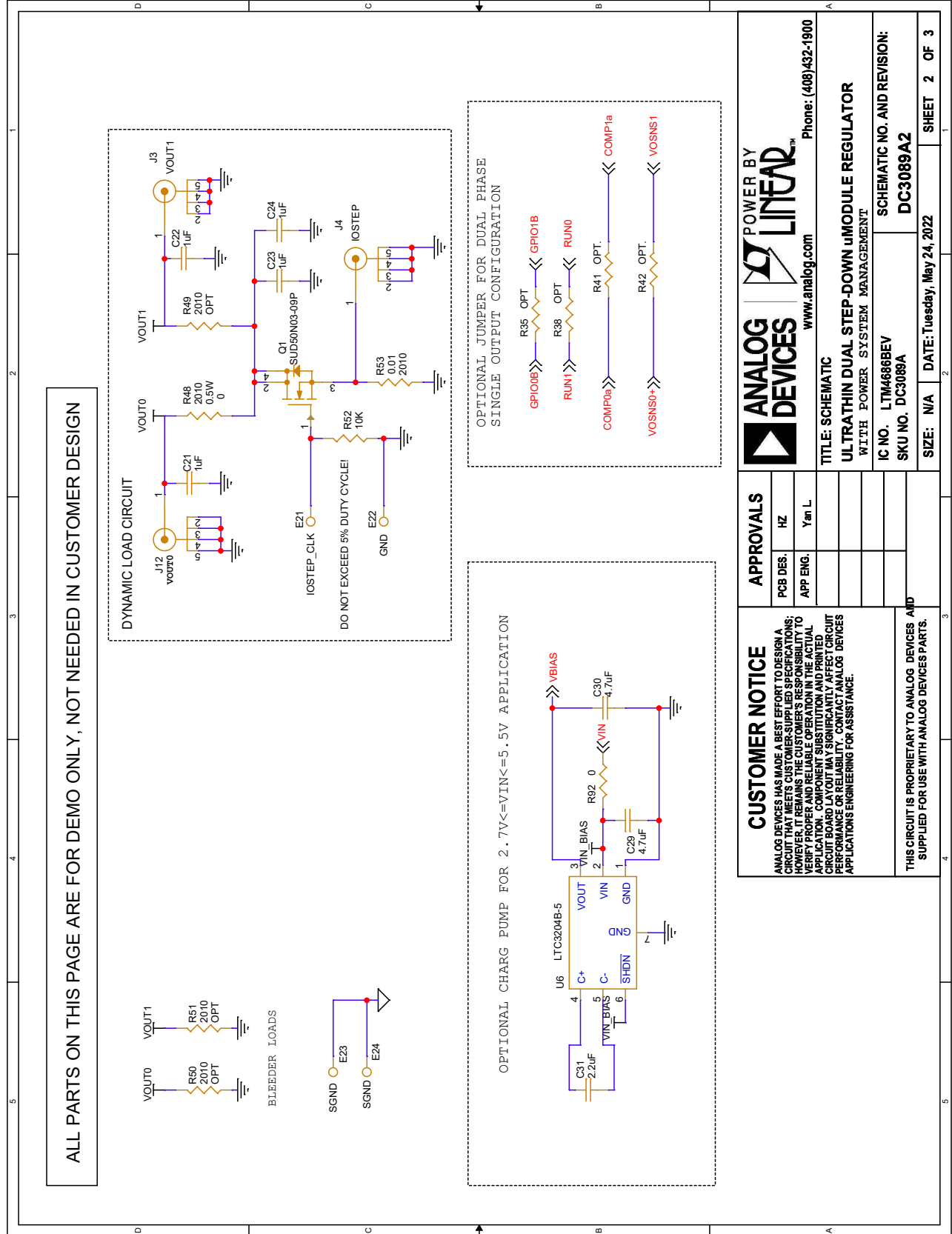

SCHEMATIC DIAGRAM

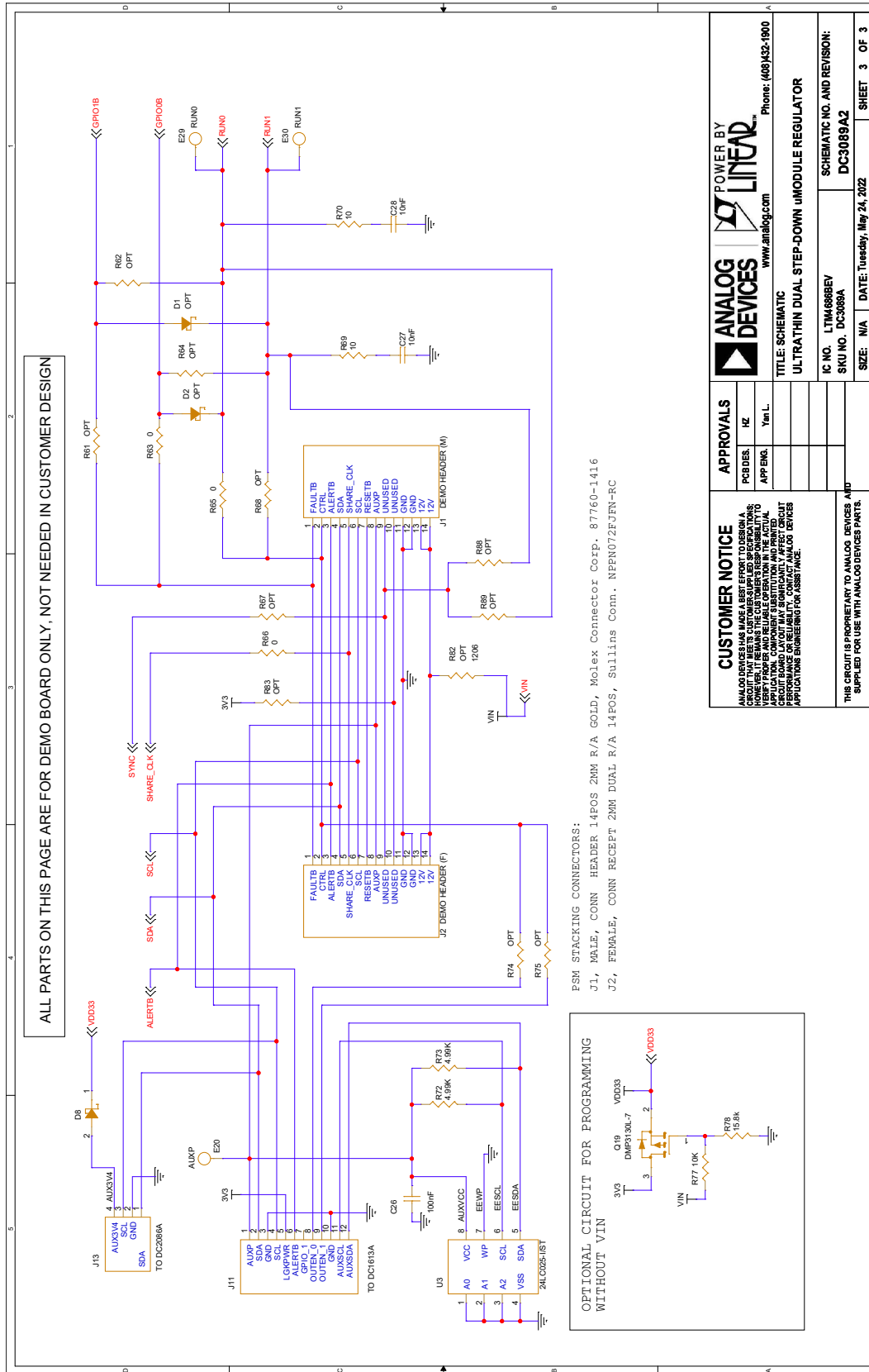

ANALOG DEVICES		POWER BY LINEAR	
www.analog.com		Phone: (408)432-1900	
TITLE: SCHEMATIC			
ULTRATHIN DUAL STEP-DOWN VIMODULE REGULATOR			
IC NO. LTM488BEV		SCHEMATIC NO. AND REVISION:	
SKU NO. DC3089A		DC3089A2	
SIZE: N/A	DATE: Tuesday, May 24, 2022	SHEET 3 OF 3	

CUSTOMER NOTICE
 ANALOG DEVICES HAS MADE A BEST EFFORT TO DESIGN A SCHEMATIC THAT REPRESENTS THE CUSTOMER'S REQUEST TO VERIFY PROPER AND RELIABLE OPERATION IN THE ACTUAL CIRCUIT BOARD LAYOUT MAY SIGNIFICANTLY AFFECT CIRCUIT APPLICATIONS ENGINEERING FOR ASSISTANCE.

APPROVALS

PCB DES.	HZ
APP ENGR.	Yan L.

CUSTOMER NOTICE
 THIS CIRCUIT IS PROPRIETARY TO ANALOG DEVICES AND SUPPLIED FOR USE WITH ANALOG DEVICES PARTS.



ESD Caution

ESD (electrostatic discharge) sensitive device. Charged devices and circuit boards can discharge without detection. Although this product features patented or proprietary protection circuitry, damage may occur on devices subjected to high energy ESD. Therefore, proper ESD precautions should be taken to avoid performance degradation or loss of functionality.

Legal Terms and Conditions

By using the evaluation board discussed herein (together with any tools, components documentation or support materials, the "Evaluation Board"), you are agreeing to be bound by the terms and conditions set forth below ("Agreement") unless you have purchased the Evaluation Board, in which case the Analog Devices Standard Terms and Conditions of Sale shall govern. Do not use the Evaluation Board until you have read and agreed to the Agreement. Your use of the Evaluation Board shall signify your acceptance of the Agreement. This Agreement is made by and between you ("Customer") and Analog Devices, Inc. ("ADI"), with its principal place of business at One Technology Way, Norwood, MA 02062, USA. Subject to the terms and conditions of the Agreement, ADI hereby grants to Customer a free, limited, personal, temporary, non-exclusive, non-sublicensable, non-transferable license to use the Evaluation Board FOR EVALUATION PURPOSES ONLY. Customer understands and agrees that the Evaluation Board is provided for the sole and exclusive purpose referenced above, and agrees not to use the Evaluation Board for any other purpose. Furthermore, the license granted is expressly made subject to the following additional limitations: Customer shall not (i) rent, lease, display, sell, transfer, assign, sublicense, or distribute the Evaluation Board; and (ii) permit any Third Party to access the Evaluation Board. As used herein, the term "Third Party" includes any entity other than ADI, Customer, their employees, affiliates and in-house consultants. The Evaluation Board is NOT sold to Customer; all rights not expressly granted herein, including ownership of the Evaluation Board, are reserved by ADI. CONFIDENTIALITY. This Agreement and the Evaluation Board shall all be considered the confidential and proprietary information of ADI. Customer may not disclose or transfer any portion of the Evaluation Board to any other party for any reason. Upon discontinuation of use of the Evaluation Board or termination of this Agreement, Customer agrees to promptly return the Evaluation Board to ADI. ADDITIONAL RESTRICTIONS. Customer may not disassemble, decompile or reverse engineer chips on the Evaluation Board. Customer shall inform ADI of any occurred damages or any modifications or alterations it makes to the Evaluation Board, including but not limited to soldering or any other activity that affects the material content of the Evaluation Board. Modifications to the Evaluation Board must comply with applicable law, including but not limited to the RoHS Directive. TERMINATION. ADI may terminate this Agreement at any time upon giving written notice to Customer. Customer agrees to return to ADI the Evaluation Board at that time. LIMITATION OF LIABILITY. THE EVALUATION BOARD PROVIDED HEREUNDER IS PROVIDED "AS IS" AND ADI MAKES NO WARRANTIES OR REPRESENTATIONS OF ANY KIND WITH RESPECT TO IT. ADI SPECIFICALLY DISCLAIMS ANY REPRESENTATIONS, ENDORSEMENTS, GUARANTEES, OR WARRANTIES, EXPRESS OR IMPLIED, RELATED TO THE EVALUATION BOARD INCLUDING, BUT NOT LIMITED TO, THE IMPLIED WARRANTY OF MERCHANTABILITY, TITLE, FITNESS FOR A PARTICULAR PURPOSE OR NON-INFRINGEMENT OF INTELLECTUAL PROPERTY RIGHTS. IN NO EVENT WILL ADI AND ITS LICENSORS BE LIABLE FOR ANY INCIDENTAL, SPECIAL, INDIRECT, OR CONSEQUENTIAL DAMAGES RESULTING FROM CUSTOMER'S POSSESSION OR USE OF THE EVALUATION BOARD, INCLUDING BUT NOT LIMITED TO LOST PROFITS, DELAY COSTS, LABOR COSTS OR LOSS OF GOODWILL. ADI'S TOTAL LIABILITY FROM ANY AND ALL CAUSES SHALL BE LIMITED TO THE AMOUNT OF ONE HUNDRED US DOLLARS (\$100.00). EXPORT. Customer agrees that it will not directly or indirectly export the Evaluation Board to another country, and that it will comply with all applicable United States federal laws and regulations relating to exports. GOVERNING LAW. This Agreement shall be governed by and construed in accordance with the substantive laws of the Commonwealth of Massachusetts (excluding conflict of law rules). Any legal action regarding this Agreement will be heard in the state or federal courts having jurisdiction in Suffolk County, Massachusetts, and Customer hereby submits to the personal jurisdiction and venue of such courts. The United Nations Convention on Contracts for the International Sale of Goods shall not apply to this Agreement and is expressly disclaimed.