

FEATURES

Excellent TCV_{OS} Match, $2 \mu V/^{\circ}C$ Max
Low Input Offset Voltage, $150 \mu V$ Max
Low Supply Current, $550 \mu A$ Max
Single Supply Operation, 5 V to 30 V
Low Input Offset Voltage Drift, $0.75 \mu V/^{\circ}C$
High Open-Loop Gain, $1500 V/mV$ Min
High PSRR, $3 \mu V/V$
Wide Common-Mode Voltage
Range, V_- to within 1.5 V of V_+
Pin Compatible with 1458, LM158, LM2904
Available in Die Form

PIN CONNECTIONS

8-Lead SOIC
(S-Suffix)

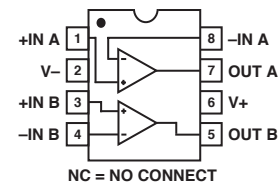

GENERAL DESCRIPTION

The OP221 is a monolithic dual operational amplifier that can be used either in single or dual supply operation. The wide supply voltage range, wide input voltage range, and low supply current drain of the OP221 make it well-suited for operation from batteries or unregulated power supplies.

The excellent specifications of the individual amplifiers combined with the tight matching and temperature tracking between channels

provide high performance in instrumentation amplifier designs. The individual amplifiers feature very low input offset voltage, low offset voltage drift, low noise voltage, and low bias current. They are fully compensated and protected.

Matching between channels is provided on all critical parameters including input offset voltage, tracking of offset voltage vs. temperature, non-inverting bias currents, and common-mode rejection.

SIMPLIFIED SCHEMATIC

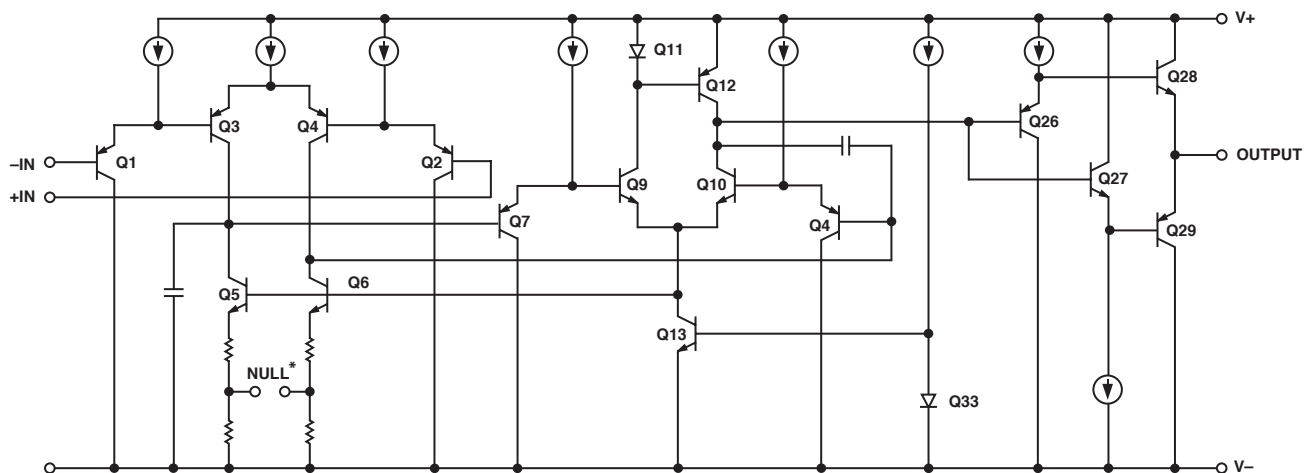

*ACCESSIBLE IN CHIP FORM ONLY

REV. C

Information furnished by Analog Devices is believed to be accurate and reliable. However, no responsibility is assumed by Analog Devices for its use, nor for any infringements of patents or other rights of third parties that may result from its use. No license is granted by implication or otherwise under any patent or patent rights of Analog Devices.

One Technology Way, P.O. Box 9106, Norwood, MA 02062-9106, U.S.A.
 Tel: 781/329-4700 www.analog.com
 Fax: 781/326-8703 © Analog Devices, Inc., 2002

OP221* PRODUCT PAGE QUICK LINKS

Last Content Update: 12/18/2017

COMPARABLE PARTS

View a parametric search of comparable parts.

EVALUATION KITS

- EVAL-OPAMP-2 Evaluation Board

DOCUMENTATION

Application Notes

- AN-112: Single Resistor Controls Wien Bridge Oscillator Frequency
- AN-21: 4-20 mA Digital-to-Process Current Transmitter

Data Sheet

- OP221: Dual Low Power Operational Amplifier, Single or Dual Supply Data Sheet

TOOLS AND SIMULATIONS

- OP221 SPICE Macro Models

DESIGN RESOURCES

- OP221 Material Declaration
- PCN-PDN Information
- Quality And Reliability
- Symbols and Footprints

DISCUSSIONS

View all OP221 EngineerZone Discussions.

SAMPLE AND BUY

Visit the product page to see pricing options.

TECHNICAL SUPPORT

Submit a technical question or find your regional support number.

DOCUMENT FEEDBACK

Submit feedback for this data sheet.

This page is dynamically generated by Analog Devices, Inc., and inserted into this data sheet. A dynamic change to the content on this page will not trigger a change to either the revision number or the content of the product data sheet. This dynamic page may be frequently modified.

OP221—SPECIFICATIONS (Electrical Characteristics at $V_S = \pm 2.5\text{ V}$ to $\pm 15\text{ V}$, $T_A = 25^\circ\text{C}$, unless otherwise noted.)

OP221G						
Parameter	Symbol	Conditions	Min	Typ	Max	Unit
Input Offset Voltage	V_{OS}			250	500	μV
Input Offset Current	I_{OS}	$V_{CM} = 0$		1.5	7	nA
Input Bias Current	I_B	$V_{CM} = 0$		70	120	nA
Input Voltage Range	IVR	$V_+ = 5\text{ V}$, $V_- = 0\text{ V}^1$ $V_S = \pm 15\text{ V}$	0/3.5 -15/13.5			V
Common-Mode Rejection Ratio	CMRR	$V_+ = -5\text{ V}$, $V_- = 0\text{ V}$ $0\text{ V} \leq V_{CM} \leq 3.5\text{ V}$ $V_S = \pm 15\text{ V}$ $-15\text{ V} \leq V_{CM} \leq 13.5\text{ V}$	75	85		dB
			80	90		
Power Supply Rejection Ratio	PSRR	$V_S = \pm 2.5\text{ V}$ to $\pm 15\text{ V}$ $V_- = 0\text{ V}$, $V_+ = 5\text{ V}$ to 30 V		32 57	100 180	$\mu\text{V/V}$
Large-Signal Voltage Gain	A_{vo}	$V_S = \pm 15\text{ V}$, $R_L = 10\text{ k}\Omega$ $V_O = \pm 10\text{ V}$	800			V/mV
Output Voltage Swing	V_O	$V_+ = 5\text{ V}$, $V_- = 0\text{ V}$ $R_L = 10\text{ k}\Omega$ $V_S = 15\text{ V}$, $R_L = 10\text{ k}\Omega$	0.8/4			V
			± 13.5			
Slew Rate	SR	$R_L = 10\text{ k}\Omega^2$	0.2	0.3		V/ μs
Bandwidth	BW			600		kHz
Supply Current (Both Amplifiers)	I_{SY}	$V_S = \pm 2.5\text{ V}$, No Load $V_S = \pm 15\text{ V}$, No Load		550	650	μA
				850	900	

SPECIFICATIONS

(Electrical Characteristics at $V_S = \pm 2.5 \text{ V}$ to $\pm 15 \text{ V}$, $-40^\circ\text{C} \leq T_A \leq +85^\circ\text{C}$, unless otherwise noted.)

OP221G						
Parameter	Symbol	Conditions	Min	Typ	Max	Unit
Average Input Offset Voltage Drift ¹	TCV_{OS}			2	3	$\mu\text{V}/^\circ\text{C}$
Input Offset Voltage	V_{OS}			400	700	μV
Input Offset Current	I_{OS}	$V_{CM} = 0$		2	10	nA
Input Bias Current	I_B	$V_{CM} = 0$		80	140	nA
Input Voltage Range	IVR	$V_+ = 5 \text{ V}$, $V_- = 0 \text{ V}^2$ $V_S = \pm 15 \text{ V}$	0/3.2 -15/13.2			V
Common-Mode Rejection Ratio	CMRR	$V_+ = -5 \text{ V}$, $V_- = 0 \text{ V}$ $0 \text{ V} \leq V_{CM} \leq 3.5 \text{ V}$ $V_S = \pm 15 \text{ V}$ $-15 \text{ V} \leq V_{CM} \leq 13.5 \text{ V}$	70 75	80 85		dB
Power Supply Rejection Ratio	PSRR	$V_S = \pm 2.5 \text{ V}$ to $\pm 15 \text{ V}$ $V_- = 0 \text{ V}$, $V_+ = 5 \text{ V}$ to 30 V		57 100	180 320	$\mu\text{V}/\text{V}$
Large-Signal Voltage Gain	A_{VO}	$V_S = \pm 15 \text{ V}$, $R_L = 10 \text{ k}\Omega$ $V_O = \pm 10 \text{ V}$	600			V/mV
Output Voltage Swing	V_O	$V_+ = 5 \text{ V}$, $V_- = 0 \text{ V}$ $R_L = 10 \text{ k}\Omega$ $V_S = 15 \text{ V}$, $R_L = 10 \text{ k}\Omega$	0.9/3.7 13.2			V
Supply Current (Both Amplifiers)	I_{SY}	$V_S = \pm 2.5 \text{ V}$, No Load $V_S = \pm 15 \text{ V}$, No Load		600 950	750 1000	μA

NOTES

¹Sample tested.²Guaranteed by CMRR test limits.

Matching Characteristics at $V_S = \pm 15 \text{ V}$, $T_A = 25^\circ\text{C}$, unless otherwise noted.

OP221G						
Parameter	Symbol	Conditions	Min	Typ	Max	Unit
Input Offset Voltage Match	ΔV_{OS}			250	600	μV
Average Noninverting Bias Current	I_{B+}				120	nA
Noninverting Input Offset Current	I_{OS+}			4	10	nA
Common-Mode Rejection Ratio Match ¹	ΔCMRR	$V_{CM} = -15 \text{ V}$ to 13.5 V	72			dB
Power Supply Rejection Ratio Match ²	ΔPSRR	$V_S = \pm 2.5 \text{ V}$ to $\pm 15 \text{ V}$			140	$\mu\text{V}/\text{V}$

NOTES

¹ ΔCMRR is $20 \log_{10} V_{CM}/\Delta\text{CME}$, where V_{CM} is the voltage applied to both noninverting inputs and ΔCME is the difference in common-mode input-referred error.² ΔPSRR is: $\frac{\text{Input-Referred Differential Error}}{\Delta V_S}$

OP221—SPECIFICATIONS (Matching Characteristics at $V_s = \pm 15\text{ V}$, $-40^\circ\text{C} \leq T_A \leq +85^\circ\text{C}$ for OP221G, unless otherwise noted. G is sample tested.)

OP221G						
Parameter	Symbol	Conditions	Min	Typ	Max	Unit
Input Offset Voltage Match	ΔV_{OS}			400	800	μV
Average Noninverting Bias Current	I_{B+}	$V_{CM} = 0$			140	nA
Input Offset Voltage Tracking	$IC\Delta V_{OS}$			3	5	$\mu\text{V}^\circ\text{C}$
Noninverting Input Offset Current	I_{OS+}	$V_{CM} = 0$		6	12	nA
Common-Mode Rejection Ratio Match ¹	ΔCMRR	$V_{CM} = -15\text{ V to } 13.2\text{ V}$	72	80		dB
Power Supply Rejection Ratio Match ²	ΔPSRR			140		$\mu\text{V}/\text{V}$

NOTES

¹ ΔCMRR is $20 \log_{10} V_{CM}/\Delta\text{CME}$, where V_{CM} is the voltage applied to both noninverting inputs and ΔCME is the difference in common-mode input-referred error.

² ΔPSRR is: $\frac{\text{Input-Referred Differential Error}}{\Delta V_s}$

ABSOLUTE MAXIMUM RATINGS (Note 1)

Supply Voltage	±18 V
Differential Input Voltage	30 V or Supply Voltage
Input Voltage	Supply Voltage
Output Short-Circuit Duration	Indefinite
Storage Temperature Range	-65°C to +150°C
Operating Temperature Range	
OP221G	-40°C to +85°C
Lead Temperature (Soldering 60 sec)	300°C
Junction Temperature (T _J)	-65°C to +150°C

Package Type	θ _{JA} (Note 2)	θ _{JC}	Unit
8-Lead SOIC(S)	158	43	°C/W

NOTES

¹Absolute maximum ratings apply to both DICE and packaged parts, unless otherwise noted.

²θ_{JA} is specified for device soldered to printed circuit board for SOIC package.

ORDERING GUIDE

T _A = +25°C V _{OS} MAX (μV)	Plastic 8-Lead	Operating Temperature Range	Package Options
150			
150			
300			
500			
500			
500	OP221GS	XIND	RN-8

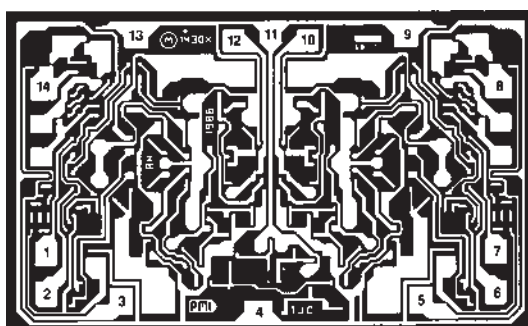

- 1. INVERTING INPUT (A)
- 2. NONINVERTING INPUT (A)
- 3. BALANCE (A)
- 4. V-
- 5. BALANCE (B)
- 6. INVERTING INPUT (B)
- 7. NONINVERTING INPUT (B)
- 8. BALANCE (B)
- 9. V+
- 10. OUT (B)
- 11. V+
- 12. OUT (A)
- 13. V+
- 14. BALANCE (A)

DIE SIZE 0.097 X 0.063 INCH, 6111 SQ. MILS
(2.464 X 1.600 MM, 3.94 SQ. MM)

NOTE: ALL V+ PADS ARE INTERNALLY CONNECTED.

Figure 1. Dice Characteristics

CAUTION

ESD (electrostatic discharge) sensitive device. Electrostatic charges as high as 4000 V readily accumulate on the human body and test equipment and can discharge without detection. Although the OP221 features proprietary ESD protection circuitry, permanent damage may occur on devices subjected to high-energy electrostatic discharges. Therefore, proper ESD precautions are recommended to avoid performance degradation or loss of functionality.



OP221—Typical Performance Characteristics

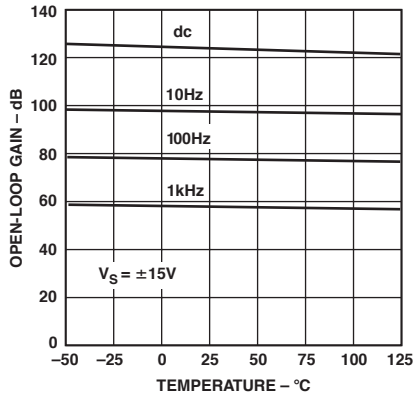

TPC 1. Open-Loop Gain at ± 15 V vs. Temperature

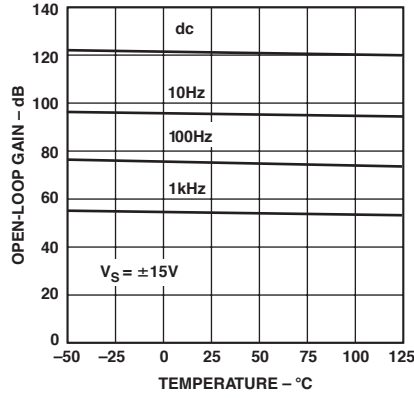

TPC 2. Open-Loop Gain at ± 5 V vs. Temperature

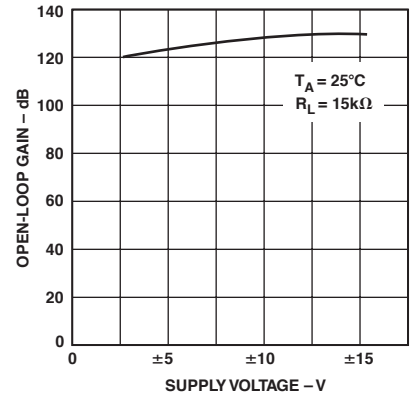

TPC 3. Open-Loop Gain at vs. Supply Voltage

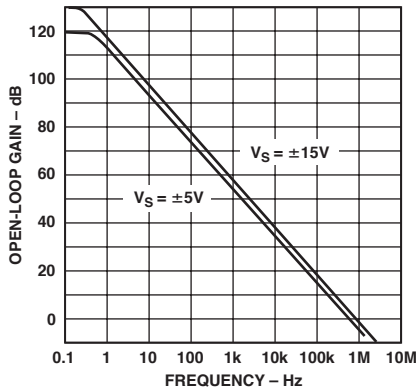

TPC 4. Open-Loop Gain at ± 15 V vs. Frequency

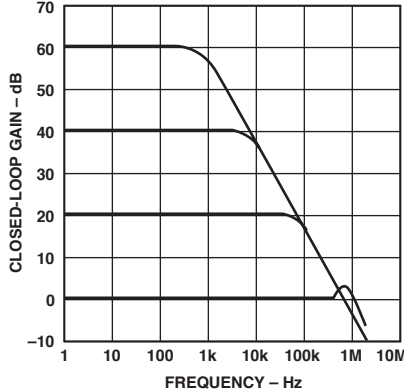

TPC 5. Closed-Loop Gain vs. Frequency

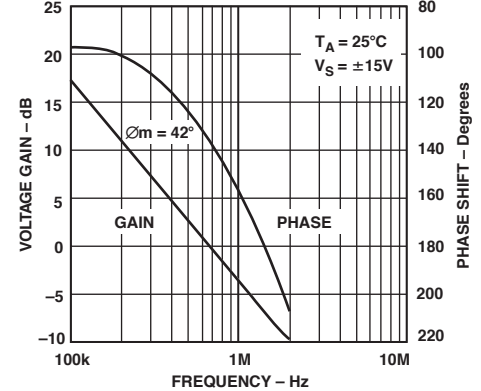

TPC 6. Gain and Phase Shift vs. Frequency

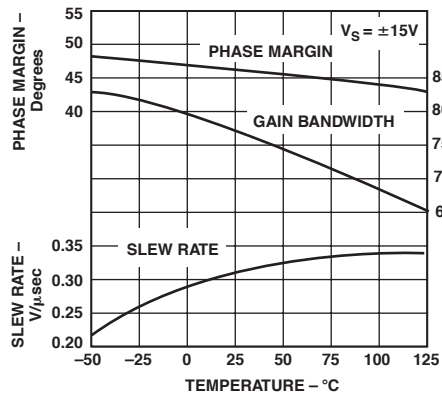

TPC 7. Phase Margin, Gain Bandwidth, and Slew Rate vs. Temperature

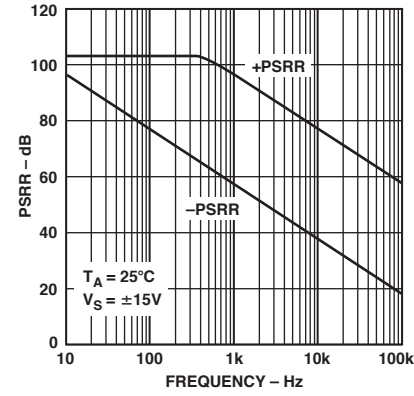

TPC 8. PSRR vs. Frequency

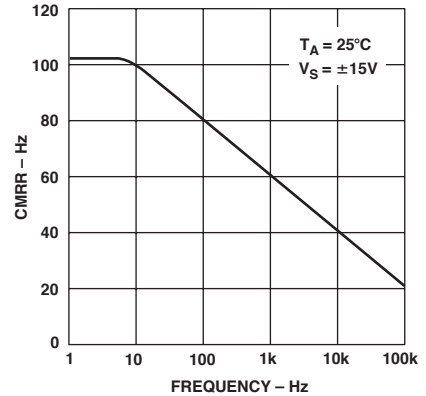

TPC 9. CMRR vs. Frequency

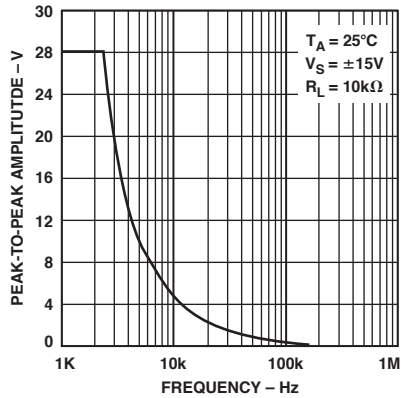

TPC 10. Maximum Output Swing vs. Frequency

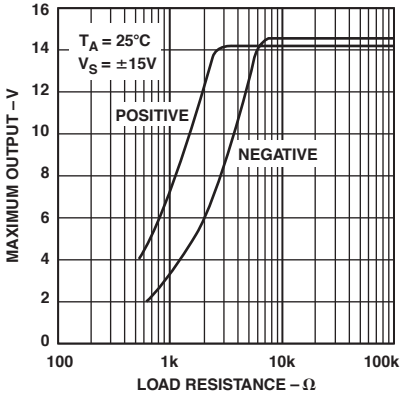

TPC 11. Maximum Output Voltage vs. Load Resistance

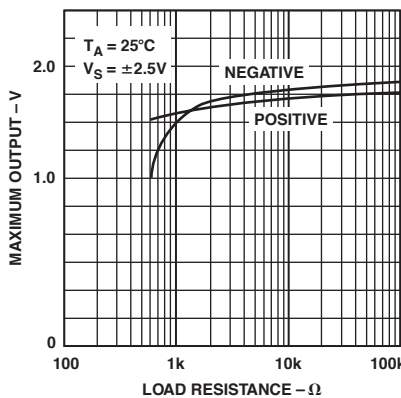

TPC 12. Maximum Output Voltage vs. Load Resistance

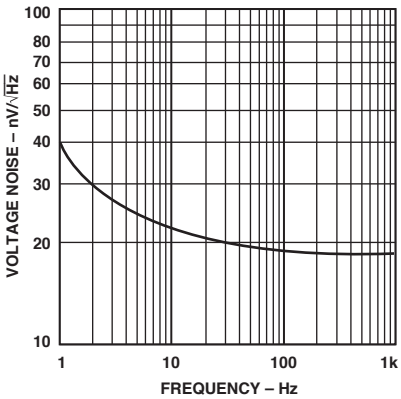

TPC 13. Voltage Noise Density vs. Frequency

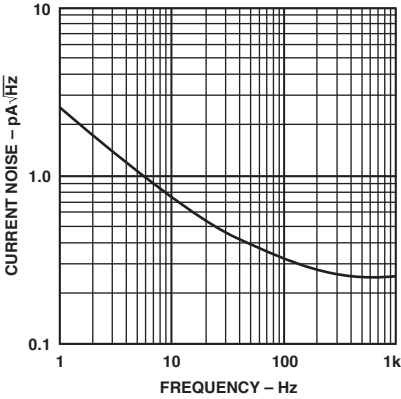

TPC 13. Current Noise Density vs. Frequency

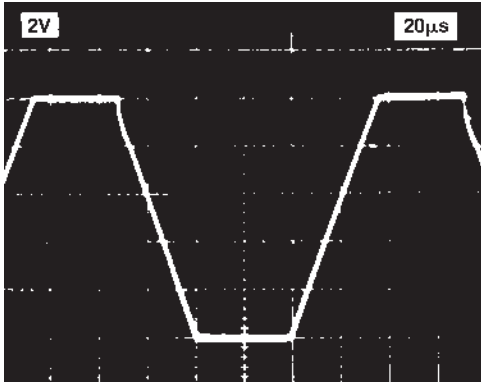

Figure 2a. Noninverting Step Response

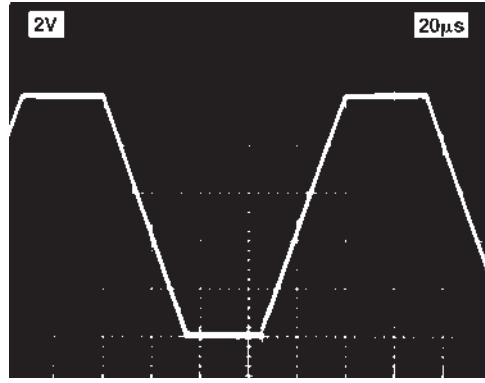

Figure 3a. Inverting Step Response

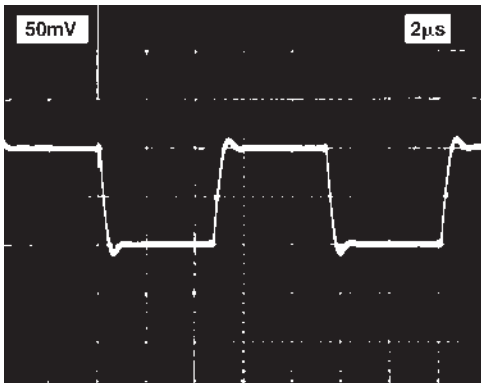

Figure 2b. Noninverting Step Response

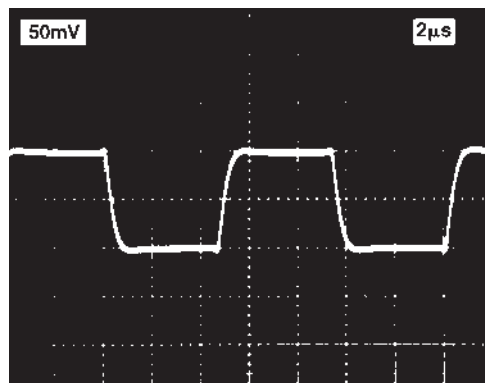

Figure 3b. Inverting Step Response

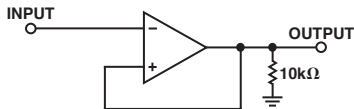

Figure 4. Noninverting Test Circuit

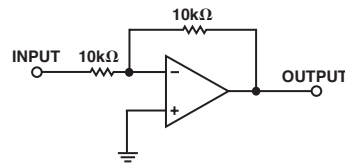

Figure 5. Inverting Test Circuit

SPECIAL NOTES ON THE APPLICATION OF DUAL MATCHED OPERATIONAL AMPLIFIERS

Advantages of Dual Monolithic Operational Amplifiers

Dual matched operational amplifiers provide the engineer with a powerful tool for designing instrumentation amplifiers and many other differential-input circuits. These designs are based on the principle that careful matching between two operational amplifiers can minimize the effect of dc errors in the individual amplifiers.

Reference to the circuit shown in Figure 6, a differential-in, differential-out amplifier, shows how the reductions in error can be accomplished. Assuming the resistors used are ideally matched, the gain of each side will be identical. If the offset voltages of each amplifier are perfectly matched, then the net differential voltage at the amplifier's output will be zero. Note that the output offset error of this amplifier is not a function of the offset voltage of the individual amplifiers, but only a function of the difference (degree of matching) between the amplifiers' offset voltages. This error-cancellation principle holds for a considerable number of input referred error parameters—offset voltage, offset voltage drift, inverting and noninverting bias currents, common mode and power supply rejection ratios. Note also that the impedances of each input, both common-mode and differential-mode, are high and tightly matched, an important feature not practical with single operation amplifier circuits.

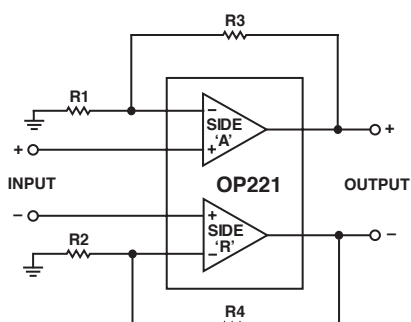

Figure 6. Differential-In, Differential-Out Amplifier

INSTRUMENTATION AMPLIFIER APPLICATIONS

Two-Op Amp Configuration

The two-op amp circuit (Figure 7) is recommended where the common-mode input voltage range is relatively limited; the common-mode and differential voltage both appear at V1. The high open-loop gain of the OP221 is very important in achieving good CMRR in this configuration. Finite open-loop gain of A1 (A_{o1}) causes undesired feedthrough of the common-mode input. For A_d/A_o << 1, the common-mode error (CME) at the output due to this effect is approximately (2 A_d/A_{o1}) x V_{CM}. This circuit features independent adjustment of CMRR and differential gain.

Three-Op Amp Configuration

The three-op amp circuit (Figure 8) has increased common-mode voltage range because the common-mode voltage is not amplified as it is in Figure 7. The CMR of this amplifier is directly proportional to the match of the CMR of the input op amps. CMRR can be raised even further by trimming the output stage resistors.

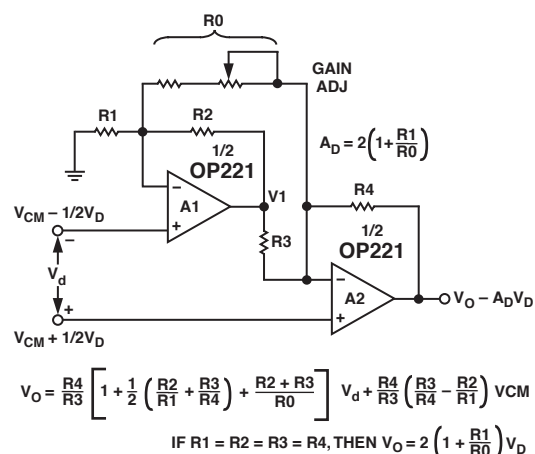

Figure 7. Two-Op Amp Circuit

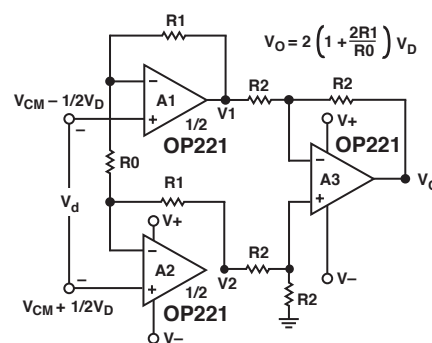
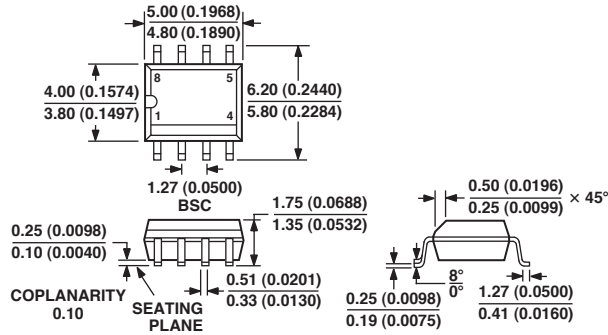

Figure 8. Three-Op Amp Circuit

OUTLINE DIMENSIONS

8-Lead Standard Small Outline Package [SOIC]
Narrow Body
(RN-8)

Dimensions shown in millimeters and (inches)



COMPLIANT TO JEDEC STANDARDS MS-012AA
CONTROLLING DIMENSIONS ARE IN MILLIMETERS; INCH DIMENSIONS
(IN PARENTHESES) ARE ROUNDED-OFF MILLIMETER EQUIVALENTS FOR
REFERENCE ONLY AND ARE NOT APPROPRIATE FOR USE IN DESIGN

Revision History

Location	Page
10/02—Data Sheet changed from REV. B to REV. C.	
Deleted 8-Lead CERDIP Package (Q-8)	Universal
Edits to SPECIFICATIONS	2-4
Edits to ABSOLUTE MAXIMUM RATINGS	5
Edits to ORDERING GUIDE	5
Updated OUTLINE DIMENSIONS	10
6/02—Data Sheet changed from REV. A to REV. B.	
Edits to 8-Lead SOIC Package (R-8)	10
09/01—Data Sheet changed from REV. 0 to REV. A.	
Edits to PIN CONNECTIONS	1
Global deletion of references to OP221B and OP221C	2, 3, 4
Edits to WAFER TEST LIMITS	4
Edits to ABSOLUTE MAXIMUM RATINGS	5
Edits to ORDERING GUIDE	5
Edits to PACKAGE TYPE	5

