

# SMD Inductors(Coils) For High Frequency(Multilayer)

Conformity to RoHS Directive

## MLG Series MLG1005S Type

### FEATURES

- Inductance values are supported from 0.3 to 390nH.
- Advanced monolithic structure is formed using a multilayering and sintering process with ceramic and conductive materials for high-frequency.
- The products contain no lead and also support lead-free soldering.
- It is a product conforming to RoHS directive.

### APPLICATIONS

For high-frequency applications including mobile phones, high frequency modules (PA, VCO, FEM etc.), Bluetooth, W-LAN, UWB and tuners.

### SHAPES AND DIMENSIONS

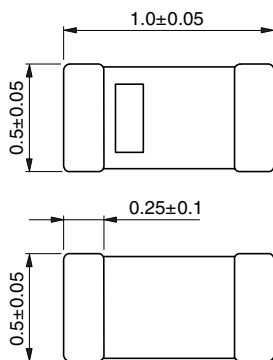

Weight: 1mg

### RECOMMENDED PC BOARD PATTERN

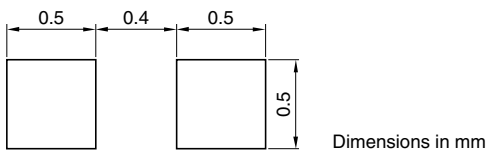

### RECOMMENDED SOLDERING CONDITION REFLOW SOLDERING

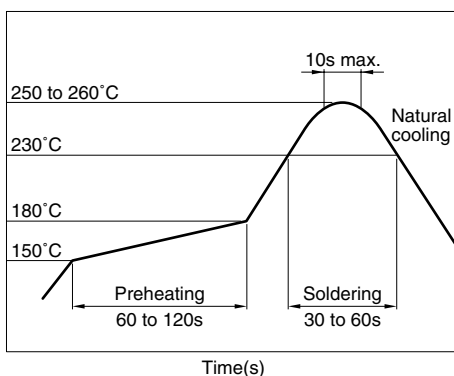

- Conformity to RoHS Directive: This means that, in conformity with EU Directive 2002/95/EC, lead, cadmium, mercury, hexavalent chromium, and specific bromine-based flame retardants, PBB and PBDE, have not been used, except for exempted applications.

- Please contact our Sales office when your application are considered the following:  
The device's failure or malfunction may directly endanger human life (e.g. application for automobile/aircraft/medical/nuclear power devices, etc.)

- All specifications are subject to change without notice.

### PRODUCT IDENTIFICATION

MLG	1005	S	2N2	S	T
(1)	(2)	(3)	(4)	(5)	(6)

(1) Series name

(2) Dimensions

1005 1.0×0.5mm (L×W)

(3) Material code

(4) Inductance value

2N2	2.2nH
12N	12nH
R10	100nH

(5) Inductance tolerance

B	±0.1nH
C	±0.2nH
S	±0.3nH
H	±3%
J	±5%

(6) Packaging style

T Taping (reel)

### SPECIFICATIONS

Operating temperature range	-55 to +125°C
Storage temperature range	-55 to +125°C

### PACKAGING STYLE AND QUANTITIES

Packaging style	Quantity
Taping	10000 pieces/reel

### HANDLING AND PRECAUTIONS

- Before soldering, be sure to preheat components.  
The preheating temperature should be set so that the temperature difference between the solder temperature and product temperature does not exceed 150°C.
- After mounting components onto the printed circuit board, do not apply stress through board bending or mishandling.
- When hand soldering, apply the soldering iron to the printed circuit board only. Temperature of the iron tip should not exceed 350°C. Soldering time should not exceed 3 seconds.

## ELECTRICAL CHARACTERISTICS

Inductance (nH)	Inductance tolerance	Q min.	Test frequency L, Q (MHz)	Self-resonant frequency (GHz)		DC resistance ( $\Omega$ )		Rated current (mA)max.	Part No.*
				min.	typ.	max.	typ.		
0.3	$\pm 0.1\text{nH}, \pm 0.2\text{nH}$	—	100	10.0	20up	0.10	0.01	1000	MLG1005S0N3□T
0.4	$\pm 0.1\text{nH}, \pm 0.2\text{nH}$	—	100	10.0	20up	0.10	0.01	1000	MLG1005S0N4□T
0.5	$\pm 0.1\text{nH}, \pm 0.2\text{nH}$	—	100	10.0	20up	0.10	0.01	1000	MLG1005S0N5□T
0.6	$\pm 0.1\text{nH}, \pm 0.2\text{nH}$	—	100	10.0	20up	0.10	0.01	1000	MLG1005S0N6□T
0.7	$\pm 0.1\text{nH}, \pm 0.2\text{nH}$	—	100	10.0	18.7	0.10	0.02	1000	MLG1005S0N7□T
0.8	$\pm 0.1\text{nH}, \pm 0.2\text{nH}$	—	100	10.0	16.4	0.10	0.02	1000	MLG1005S0N8□T
0.9	$\pm 0.1\text{nH}, \pm 0.2\text{nH}$	—	100	10.0	17.7	0.10	0.04	1000	MLG1005S0N9□T
1.0	$\pm 0.1\text{nH}, \pm 0.2, 0.3\text{nH}$	7	100	10.0	13.8	0.10	0.04	1000	MLG1005S1N0□T
1.1	$\pm 0.1\text{nH}, \pm 0.2, 0.3\text{nH}$	7	100	10.0	19.3	0.10	0.03	1000	MLG1005S1N1□T
1.2	$\pm 0.1\text{nH}, \pm 0.2, 0.3\text{nH}$	7	100	10.0	11.6	0.10	0.04	1000	MLG1005S1N2□T
1.3	$\pm 0.1\text{nH}, \pm 0.2, 0.3\text{nH}$	7	100	8.00	11.7	0.10	0.04	1000	MLG1005S1N3□T
1.5	$\pm 0.1\text{nH}, \pm 0.2, 0.3\text{nH}$	7	100	8.00	9.6	0.10	0.06	1000	MLG1005S1N5□T
1.6	$\pm 0.1\text{nH}, \pm 0.2, 0.3\text{nH}$	7	100	7.50	9.4	0.12	0.05	1000	MLG1005S1N6□T
1.8	$\pm 0.1\text{nH}, \pm 0.2, 0.3\text{nH}$	7	100	8.00	10.3	0.15	0.06	900	MLG1005S1N8□T
2.0	$\pm 0.1\text{nH}, \pm 0.2, 0.3\text{nH}$	7	100	7.50	9.3	0.15	0.07	900	MLG1005S2N0□T
2.2	$\pm 0.1\text{nH}, \pm 0.2, 0.3\text{nH}$	7	100	7.00	8.6	0.15	0.08	900	MLG1005S2N2□T
2.4	$\pm 0.1\text{nH}, \pm 0.2, 0.3\text{nH}$	7	100	7.00	8.2	0.15	0.08	800	MLG1005S2N4□T
2.7	$\pm 0.1\text{nH}, \pm 0.2, 0.3\text{nH}$	7	100	6.00	7.3	0.15	0.08	800	MLG1005S2N7□T
3.0	$\pm 0.1\text{nH}, \pm 0.2, 0.3\text{nH}$	7	100	5.50	6.8	0.20	0.09	800	MLG1005S3N0□T
3.3	$\pm 0.1\text{nH}, \pm 0.2, 0.3\text{nH}$	8	100	5.00	6.1	0.20	0.09	800	MLG1005S3N3□T
3.6	$\pm 0.1\text{nH}, \pm 0.2, 0.3\text{nH}$	8	100	5.00	6.7	0.20	0.09	700	MLG1005S3N6□T
3.9	$\pm 0.1\text{nH}, \pm 0.2, 0.3\text{nH}$	8	100	5.00	6.5	0.20	0.11	700	MLG1005S3N9□T
4.3	$\pm 0.2\text{nH}, \pm 0.3\text{nH}$	8	100	4.50	6.0	0.20	0.11	700	MLG1005S4N3□T
4.7	$\pm 0.2\text{nH}, \pm 0.3\text{nH}$	8	100	4.50	5.4	0.25	0.12	700	MLG1005S4N7□T
5.1	$\pm 0.2\text{nH}, \pm 0.3\text{nH}$	8	100	4.00	5.0	0.25	0.13	600	MLG1005S5N1□T
5.6	$\pm 0.2\text{nH}, \pm 0.3\text{nH}$	8	100	4.00	5.3	0.25	0.14	600	MLG1005S5N6□T
6.2	$\pm 3\%, \pm 0.3\text{nH}$	8	100	4.00	4.7	0.25	0.16	600	MLG1005S6N2□T
6.8	$\pm 3\%, \pm 5\%$	8	100	3.50	4.4	0.25	0.15	600	MLG1005S6N8□T
7.5	$\pm 3\%, \pm 5\%$	8	100	3.00	4.1	0.25	0.15	500	MLG1005S7N5□T
8.2	$\pm 3\%, \pm 5\%$	8	100	3.00	4.0	0.30	0.19	500	MLG1005S8N2□T
9.1	$\pm 3\%, \pm 5\%$	8	100	3.00	3.8	0.30	0.20	500	MLG1005S9N1□T
10	$\pm 3\%, \pm 5\%$	8	100	2.50	3.4	0.35	0.22	500	MLG1005S10N□T
11	$\pm 3\%, \pm 5\%$	8	100	2.50	3.5	0.40	0.28	400	MLG1005S11N□T
12	$\pm 3\%, \pm 5\%$	8	100	2.50	3.0	0.40	0.25	400	MLG1005S12N□T
13	$\pm 3\%, \pm 5\%$	8	100	2.40	2.9	0.50	0.26	400	MLG1005S13N□T
15	$\pm 3\%, \pm 5\%$	8	100	2.20	2.8	0.55	0.35	400	MLG1005S15N□T
16	$\pm 3\%, \pm 5\%$	8	100	2.10	2.7	0.55	0.32	400	MLG1005S16N□T
18	$\pm 3\%, \pm 5\%$	8	100	2.00	2.5	0.60	0.40	350	MLG1005S18N□T
20	$\pm 3\%, \pm 5\%$	8	100	1.90	2.4	0.60	0.38	350	MLG1005S20N□T
22	$\pm 3\%, \pm 5\%$	8	100	1.70	2.2	0.70	0.46	350	MLG1005S22N□T
24	$\pm 3\%, \pm 5\%$	8	100	1.70	2.1	0.70	0.43	350	MLG1005S24N□T
27	$\pm 3\%, \pm 5\%$	8	100	1.60	2.0	0.80	0.53	300	MLG1005S27N□T
30	$\pm 3\%, \pm 5\%$	8	100	1.50	1.9	0.80	0.50	300	MLG1005S30N□T
33	$\pm 3\%, \pm 5\%$	8	100	1.40	1.8	0.90	0.59	300	MLG1005S33N□T
36	$\pm 3\%, \pm 5\%$	8	100	1.30	1.7	1.00	0.62	250	MLG1005S36N□T
39	$\pm 3\%, \pm 5\%$	8	100	1.20	1.6	1.00	0.65	250	MLG1005S39N□T
43	$\pm 3\%, \pm 5\%$	8	100	1.20	1.6	1.10	0.67	250	MLG1005S43N□T
47	$\pm 3\%, \pm 5\%$	8	100	1.10	1.4	1.20	0.75	250	MLG1005S47N□T
51	$\pm 3\%, \pm 5\%$	8	100	1.10	1.5	1.20	0.72	250	MLG1005S51N□T
56	$\pm 3\%, \pm 5\%$	8	100	1.00	1.3	1.30	0.83	200	MLG1005S56N□T
62	$\pm 3\%, \pm 5\%$	8	100	1.00	1.3	1.40	0.85	200	MLG1005S62N□T
68	$\pm 3\%, \pm 5\%$	8	100	0.80	1.1	1.50	0.87	200	MLG1005S68N□T
75	$\pm 3\%, \pm 5\%$	8	100	0.75	1.1	1.50	0.93	200	MLG1005S75N□T
82	$\pm 3\%, \pm 5\%$	8	100	0.70	1.0	1.60	1.01	200	MLG1005S82N□T
91	$\pm 3\%, \pm 5\%$	8	100	0.70	0.9	1.80	1.14	200	MLG1005S91N□T

\* □: Please specify inductance tolerance, (B $\pm 0.1\text{nH}$ ), (C $\pm 0.2\text{nH}$ ), (S $\pm 0.3\text{nH}$ ), (H $\pm 3\%$ ) or (J $\pm 5\%$ ).

Please contact us for information on inductance tolerance, G( $\pm 2\%$ ).

## • Test equipment

Inductance Q : HP4291A+16193A, or equivalent

SRF: HP8720C, or equivalent

Rdc: YOKOGAWA TYPE7561, or equivalent

• All specifications are subject to change without notice.

**ELECTRICAL CHARACTERISTICS**

Inductance (nH)	Inductance tolerance	Q min.	Test frequency L, Q (MHz)	Self-resonant frequency (GHz)		DC resistance ( $\Omega$ )		Rated current (mA)max.	Part No.*
				min.	typ.	max.	typ.		
100	$\pm 3\%$ , $\pm 5\%$	8	100	0.70	0.9	2.00	1.37	200	MLG1005SR10□T
110	$\pm 3\%$ , $\pm 5\%$	8	100	0.70	0.9	2.20	1.48	150	MLG1005SR11□T
120	$\pm 3\%$ , $\pm 5\%$	8	100	0.60	0.8	2.20	1.48	150	MLG1005SR12□T
130	$\pm 3\%$ , $\pm 5\%$	8	100	0.60	0.8	2.50	1.68	150	MLG1005SR13□T
150	$\pm 3\%$ , $\pm 5\%$	8	100	0.55	0.7	3.50	2.44	150	MLG1005SR15□T
160	$\pm 3\%$ , $\pm 5\%$	8	100	0.50	0.6	3.80	2.74	150	MLG1005SR16□T
180	$\pm 3\%$ , $\pm 5\%$	8	100	0.50	0.6	3.80	2.88	150	MLG1005SR18□T
200	$\pm 3\%$ , $\pm 5\%$	8	100	0.42	0.5	4.20	3.15	100	MLG1005SR20□T
220	$\pm 3\%$ , $\pm 5\%$	8	100	0.45	0.5	4.20	3.02	100	MLG1005SR22□T
240	$\pm 3\%$ , $\pm 5\%$	8	100	0.40	0.5	4.80	3.42	100	MLG1005SR24□T
270	$\pm 3\%$ , $\pm 5\%$	8	100	0.40	0.5	4.80	3.54	100	MLG1005SR27□T
300	$\pm 3\%$ , $\pm 5\%$	6	50	0.35	0.4	6.50	4.82	50	MLG1005SR30□T
330	$\pm 3\%$ , $\pm 5\%$	6	50	0.35	0.4	7.00	5.21	50	MLG1005SR33□T
360	$\pm 3\%$ , $\pm 5\%$	6	50	0.30	0.4	7.50	5.39	50	MLG1005SR36□T
390	$\pm 3\%$ , $\pm 5\%$	6	50	0.30	0.4	8.00	5.97	50	MLG1005SR39□T

\* □: Please specify inductance tolerance, (B $\pm$ 0.1nH), (C $\pm$ 0.2nH), (S $\pm$ 0.3nH), (H $\pm$ 3%) or (J $\pm$ 5%).

Please contact us for information on inductance tolerance, G( $\pm$ 2%).

• Test equipment

Inductance Q : HP4291A+16193A, or equivalent

SRF: HP8720C, or equivalent

Rdc: YOKOGAWA TYPE7561, or equivalent

**L, Q vs. FREQUENCY CHARACTERISTICS**

Part No.	Inductance(nH)typ.					Q typ.				
	500MHz	800MHz	1.8GHz	2.0GHz	2.4GHz	500MHz	800MHz	1.8GHz	2.0GHz	2.4GHz
MLG1005S0N3	0.3	0.3	0.3	0.3	0.3	39	48	99	117	127
MLG1005S0N4	0.4	0.4	0.4	0.4	0.4	41	48	98	109	117
MLG1005S0N5	0.5	0.5	0.5	0.5	0.5	26	32	58	63	69
MLG1005S0N6	0.6	0.6	0.6	0.6	0.6	22	27	46	49	53
MLG1005S0N7	0.7	0.7	0.7	0.7	0.7	22	28	45	49	54
MLG1005S0N8	0.8	0.8	0.8	0.8	0.8	26	34	57	60	66
MLG1005S0N9	0.9	0.8	0.8	0.8	0.8	21	27	44	47	53
MLG1005S1N0	0.9	0.9	0.9	0.9	0.9	22	29	48	50	56
MLG1005S1N1	1.0	1.0	1.0	1.0	1.0	23	29	47	50	57
MLG1005S1N2	1.1	1.1	1.1	1.1	1.1	23	29	48	50	56
MLG1005S1N3	1.2	1.2	1.2	1.2	1.2	22	27	44	47	53
MLG1005S1N5	1.4	1.4	1.4	1.5	1.5	23	29	47	50	56
MLG1005S1N6	1.5	1.5	1.5	1.6	1.6	23	29	46	49	54
MLG1005S1N8	1.7	1.7	1.7	1.7	1.7	20	26	41	43	49
MLG1005S2N0	1.9	1.9	1.9	1.9	1.9	21	25	41	43	48
MLG1005S2N2	2.1	2.1	2.1	2.1	2.2	22	27	44	47	52
MLG1005S2N4	2.3	2.3	2.3	2.3	2.4	21	26	42	44	49
MLG1005S2N7	2.6	2.6	2.6	2.7	2.7	22	27	43	45	50
MLG1005S3N0	2.9	2.9	3.0	3.0	3.1	24	29	47	49	54
MLG1005S3N3	3.2	3.2	3.3	3.4	3.5	24	30	46	48	53
MLG1005S3N6	3.4	3.4	3.6	3.6	3.8	21	26	40	42	46
MLG1005S3N9	3.7	3.7	3.9	3.9	4.1	22	28	43	45	50
MLG1005S4N3	4.1	4.1	4.3	4.4	4.6	24	30	47	49	53
MLG1005S4N7	4.5	4.5	4.8	4.9	5.2	23	30	45	47	50
MLG1005S5N1	4.9	4.9	5.4	5.6	6.1	23	29	42	43	44
MLG1005S5N6	5.4	5.4	5.8	5.9	6.3	22	28	42	43	45
MLG1005S6N2	6.0	6.0	6.8	7.1	7.8	24	29	42	43	43
MLG1005S6N8	6.5	6.6	7.4	7.8	8.6	23	28	40	41	41
MLG1005S7N5	7.2	7.4	8.6	9.2	10.5	24	30	41	41	39
MLG1005S8N2	7.9	8.0	9.3	9.9	11.3	23	28	38	38	36
MLG1005S9N1	8.8	9.0	10.8	11.6	13.7	24	30	40	39	36
MLG1005S10N	9.7	9.9	12.4	13.5	16.7	24	30	37	36	31
MLG1005S11N	10.6	10.9	13.8	15.1	19.0	23	28	34	33	28
MLG1005S12N	11.7	12.1	16.2	18.3	25.5	23	29	33	31	23
MLG1005S13N	12.6	13.0	18.3	21.3	32.4	20	24	25	22	15
MLG1005S15N	14.7	15.3	22.0	26.0	41.7	23	28	29	26	17
MLG1005S16N	15.6	16.2	24.1	29.0	50.2	22	26	26	22	13
MLG1005S18N	17.7	18.6	29.0	36.1	74.4	23	28	26	22	11
MLG1005S20N	19.7	20.8	36.8	50.3	215.3	21	25	21	16	4
MLG1005S22N	21.8	23.3	44.5	65.1	341.5	22	27	21	14	2
MLG1005S24N	23.8	25.5	53.8	86.9		22	26	17	11	3
MLG1005S27N	27.0	29.6	92.4	317.8		20	23	10	3	
MLG1005S30N	30.1	33.5	150.1			19	21	6	1	
MLG1005S33N	33.5	37.8	314.7			20	23	3		
MLG1005S36N	36.7	41.5				21	23	2		
MLG1005S39N	40.3	46.9				20	21			
MLG1005S43N	44.3	51.6				20	21			
MLG1005S47N	50.2	63.2				19	20			
MLG1005S51N	53.7	65.6				19	19			
MLG1005S56N	60.9	80.2				19	18			
MLG1005S62N	67.5	89.8				18	16			
MLG1005S68N	75.8	107.5				17	15			
MLG1005S75N	86.5	135.2				17	13			
MLG1005S82N	96.9	164.8				16	11			
MLG1005S91N	111.0	217.9				15	9			
MLG1005SR10	128.9	325.8				14	6			
MLG1005SR11	140.8	343.1				15	7			
MLG1005SR12	175.2					12	1			
MLG1005SR13	187.8					13	2			
MLG1005SR15	284.7					11				
MLG1005SR16	356.9					9				
MLG1005SR18	422.4					8				
MLG1005SR20						4				
MLG1005SR22						5				
MLG1005SR24						1				
MLG1005SR27										
MLG1005SR30										
MLG1005SR33										
MLG1005SR36										
MLG1005SR39										

• All specifications are subject to change without notice.

### TYPICAL ELECTRICAL CHARACTERISTICS INDUCTANCE vs. FREQUENCY CHARACTERISTICS

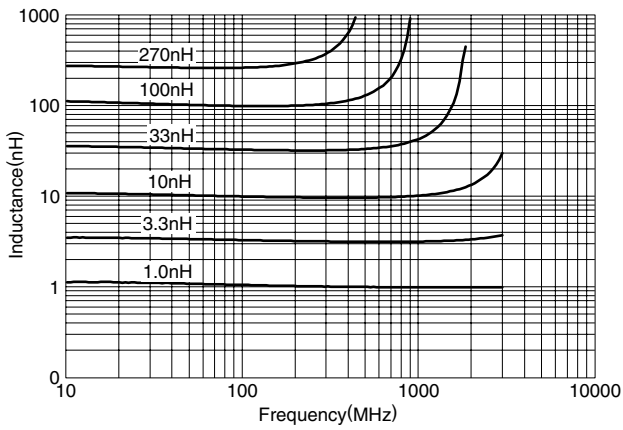

### Q vs. FREQUENCY CHARACTERISTICS

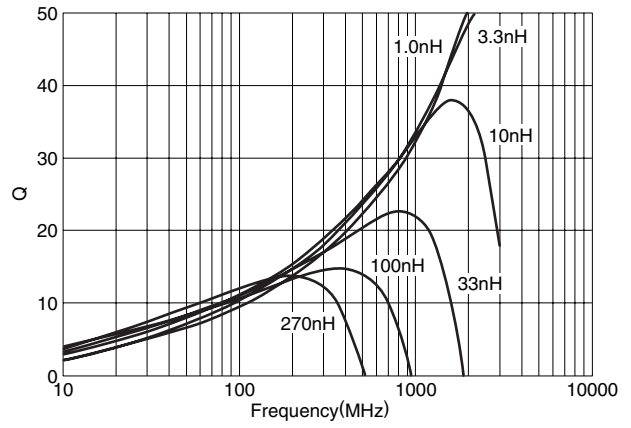

### PACKAGING STYLES REEL DIMENSIONS

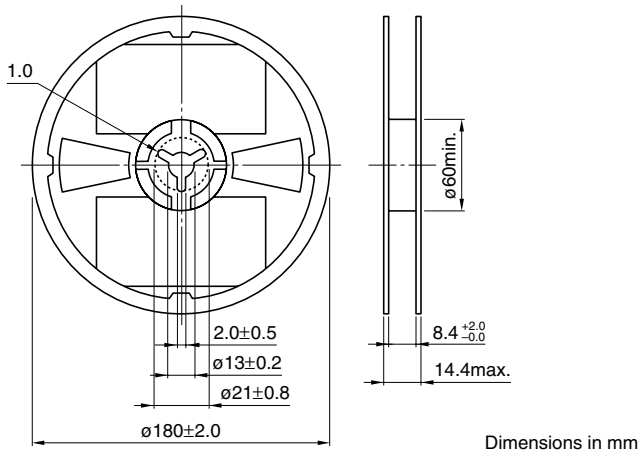

### TAPE DIMENSIONS

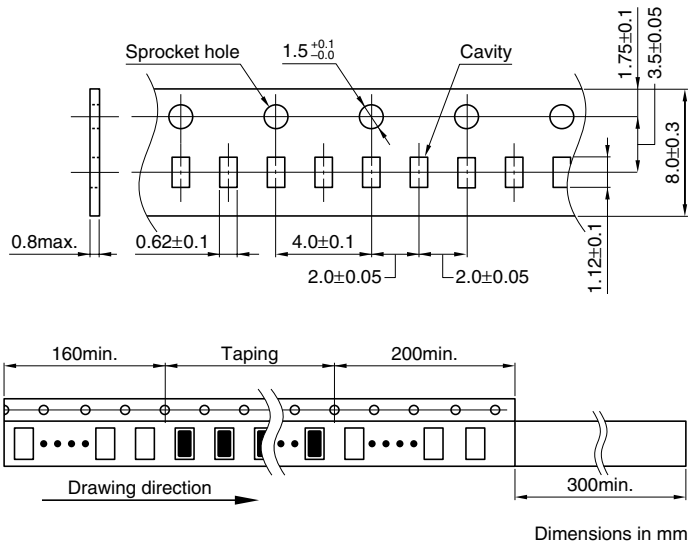

• All specifications are subject to change without notice.