

Inductors for high frequency circuits
Multilayer ceramic
MLG series



MLG0603S type



FEATURES

- Advanced monolithic structure is formed using a multilayering and sintering process with ceramic and conductive materials for high-frequency.
- Operating temperature range: -55 to +125°C

APPLICATION

- Smart phones, tablet terminals, high frequency modules (PAs, VCOs, FEMs , etc.), Bluetooth, W-LAN, UWB, tuners and other high frequency circuits for the mobile communication industry
- Application guides: [Smart phones/tablets](#)

PART NUMBER CONSTRUCTION

MLG	0603	S	0N3	S	T	000
Series name	LxWxH dimensions 0.6x0.3x0.3 mm	Product internal code	Inductance (nH)	Inductance tolerance	Packaging style	Internal code



MLG0603S type

CHARACTERISTICS SPECIFICATION TABLE

L (nH)	Q Tolerance	Q min.	L, Q measuring frequency (MHz)	Self-resonant frequency		DC resistance		Rated current (mA)max.	Part No.*
				(GHz)min.	(GHz)typ.	(Ω)max.	(Ω)typ.		
0.3	± 0.1 nH	—	100	10.0	20up	0.10	0.02	600	MLG0603S0N3BT000
0.3	± 0.2 nH	—	100	10.0	20up	0.10	0.02	600	MLG0603S0N3CT000
0.4	± 0.1 nH	—	100	10.0	20up	0.10	0.02	600	MLG0603S0N4BT000
0.4	± 0.2 nH	—	100	10.0	20up	0.10	0.02	600	MLG0603S0N4CT000
0.5	± 0.1 nH	—	100	10.0	20up	0.10	0.02	600	MLG0603S0N5BT000
0.5	± 0.2 nH	—	100	10.0	20up	0.10	0.02	600	MLG0603S0N5CT000
0.6	± 0.1 nH	—	100	10.0	20up	0.10	0.02	600	MLG0603S0N6BT000
0.6	± 0.2 nH	—	100	10.0	20up	0.10	0.02	600	MLG0603S0N6CT000
0.7	± 0.1 nH	—	100	10.0	16.3	0.10	0.02	600	MLG0603S0N7BT000
0.7	± 0.2 nH	—	100	10.0	16.3	0.10	0.02	600	MLG0603S0N7CT000
0.8	± 0.1 nH	—	100	10.0	16.1	0.10	0.03	600	MLG0603S0N8BT000
0.8	± 0.2 nH	—	100	10.0	16.1	0.10	0.03	600	MLG0603S0N8CT000
0.9	± 0.1 nH	—	100	10.0	13.8	0.10	0.03	600	MLG0603S0N9BT000
0.9	± 0.2 nH	—	100	10.0	13.8	0.10	0.03	600	MLG0603S0N9CT000
1.0	± 0.1 nH	4	100	10.0	14.4	0.10	0.04	600	MLG0603S1N0BT000
1.0	± 0.2 nH	4	100	10.0	14.4	0.10	0.04	600	MLG0603S1N0CT000
1.0	± 0.3 nH	4	100	10.0	14.4	0.10	0.04	600	MLG0603S1N0ST000
1.1	± 0.1 nH	4	100	10.0	13.6	0.15	0.04	550	MLG0603S1N1BT000
1.1	± 0.2 nH	4	100	10.0	13.6	0.15	0.04	550	MLG0603S1N1CT000
1.1	± 0.3 nH	4	100	10.0	13.6	0.15	0.04	550	MLG0603S1N1ST000
1.2	± 0.1 nH	4	100	10.0	12.3	0.15	0.06	550	MLG0603S1N2BT000
1.2	± 0.2 nH	4	100	10.0	12.3	0.15	0.06	550	MLG0603S1N2CT000
1.2	± 0.3 nH	4	100	10.0	12.3	0.15	0.06	550	MLG0603S1N2ST000
1.3	± 0.1 nH	4	100	9.0	11.4	0.15	0.07	550	MLG0603S1N3BT000
1.3	± 0.2 nH	4	100	9.0	11.4	0.15	0.07	550	MLG0603S1N3CT000
1.3	± 0.3 nH	4	100	9.0	11.4	0.15	0.07	550	MLG0603S1N3ST000
1.5	± 0.1 nH	4	100	9.0	10.4	0.15	0.07	550	MLG0603S1N5BT000
1.5	± 0.2 nH	4	100	9.0	10.4	0.15	0.07	550	MLG0603S1N5CT000
1.5	± 0.3 nH	4	100	9.00	10.4	0.15	0.07	550	MLG0603S1N5ST000
1.6	± 0.1 nH	4	100	9.0	11.5	0.20	0.09	500	MLG0603S1N6BT000
1.6	± 0.2 nH	4	100	9.0	11.5	0.20	0.09	500	MLG0603S1N6CT000
1.6	± 0.3 nH	4	100	9.00	11.5	0.20	0.09	500	MLG0603S1N6ST000
1.8	± 0.1 nH	4	100	8.5	10.0	0.20	0.12	500	MLG0603S1N8BT000
1.8	± 0.2 nH	4	100	8.5	10.0	0.20	0.12	500	MLG0603S1N8CT000
1.8	± 0.3 nH	4	100	8.50	10.0	0.20	0.12	500	MLG0603S1N8ST000
2.0	± 0.1 nH	4	100	8.2	9.80	0.25	0.14	400	MLG0603S2N0BT000
2.0	± 0.2 nH	4	100	8.2	9.80	0.25	0.14	400	MLG0603S2N0CT000
2.0	± 0.3 nH	4	100	8.20	9.80	0.25	0.14	400	MLG0603S2N0ST000
2.2	± 0.1 nH	4	100	8.0	8.90	0.25	0.14	400	MLG0603S2N2BT000
2.2	± 0.2 nH	4	100	8.0	8.90	0.25	0.14	400	MLG0603S2N2CT000
2.2	± 0.3 nH	4	100	8.00	8.90	0.25	0.14	400	MLG0603S2N2ST000
2.4	± 0.1 nH	4	100	8.0	9.20	0.25	0.15	300	MLG0603S2N4BT000
2.4	± 0.2 nH	4	100	8.0	9.20	0.25	0.15	300	MLG0603S2N4CT000
2.4	± 0.3 nH	4	100	8.00	9.20	0.25	0.15	300	MLG0603S2N4ST000
2.7	± 0.1 nH	4	100	6.5	8.10	0.25	0.15	300	MLG0603S2N7BT000
2.7	± 0.2 nH	4	100	6.5	8.10	0.25	0.15	300	MLG0603S2N7CT000
2.7	± 0.3 nH	4	100	6.50	8.10	0.25	0.15	300	MLG0603S2N7ST000

*Please contact us for information on inductance tolerance, G ($\pm 2\%$).

Measurement equipment

Measurement item	Product No.	Manufacturer
L, Q	4291B+16197A	Keysight Technologies
Self-resonant frequency	8720C	Keysight Technologies
DC resistance	Type-7561	Yokogawa

* Equivalent measurement equipment may be used.

MLG0603S type

CHARACTERISTICS SPECIFICATION TABLE

L (nH)	Q Tolerance	Q min.	L, Q measuring frequency (MHz)	Self-resonant frequency		DC resistance		Rated current (mA)max.	Part No.*
				(GHz)min.	(GHz)typ.	(Ω)max.	(Ω)typ.		
3.0	± 0.1 nH	4	100	6.2	7.80	0.30	0.20	300	MLG0603S3N0BT000
3.0	± 0.2 nH	4	100	6.2	7.80	0.30	0.20	300	MLG0603S3N0CT000
3.0	± 0.3 nH	4	100	6.20	7.80	0.30	0.20	300	MLG0603S3N0ST000
3.3	± 0.1 nH	4	100	5.8	7.00	0.35	0.23	300	MLG0603S3N3BT000
3.3	± 0.2 nH	4	100	5.8	7.00	0.35	0.23	300	MLG0603S3N3CT000
3.3	± 0.3 nH	4	100	5.80	7.00	0.35	0.23	300	MLG0603S3N3ST000
3.6	± 0.1 nH	4	100	5.5	6.90	0.35	0.22	300	MLG0603S3N6BT000
3.6	± 0.2 nH	4	100	5.5	6.90	0.35	0.22	300	MLG0603S3N6CT000
3.6	± 0.3 nH	4	100	5.50	6.90	0.35	0.22	300	MLG0603S3N6ST000
3.9	± 0.1 nH	5	100	5.0	6.60	0.40	0.27	300	MLG0603S3N9BT000
3.9	± 0.2 nH	5	100	5.0	6.60	0.40	0.27	300	MLG0603S3N9CT000
3.9	± 0.3 nH	5	100	5.00	6.60	0.40	0.27	300	MLG0603S3N9ST000
4.3	± 0.3 nH	5	100	5.00	6.40	0.40	0.27	300	MLG0603S4N3ST000
4.3	$\pm 3\%$	5	100	5.00	6.40	0.40	0.27	300	MLG0603S4N3HT000
4.7	± 0.3 nH	5	100	4.50	5.40	0.45	0.28	300	MLG0603S4N7ST000
4.7	$\pm 3\%$	5	100	4.50	5.40	0.45	0.28	300	MLG0603S4N7HT000
5.1	± 0.3 nH	5	100	4.50	5.50	0.45	0.23	250	MLG0603S5N1ST000
5.1	$\pm 3\%$	5	100	4.50	5.50	0.45	0.23	250	MLG0603S5N1HT000
5.6	± 0.3 nH	5	100	4.20	5.30	0.50	0.31	250	MLG0603S5N6ST000
5.6	$\pm 3\%$	5	100	4.20	5.30	0.50	0.31	250	MLG0603S5N6HT000
6.2	± 0.3 nH	5	100	4.20	5.10	0.55	0.32	250	MLG0603S6N2ST000
6.2	$\pm 3\%$	5	100	4.20	5.10	0.55	0.32	250	MLG0603S6N2HT000
6.8	$\pm 3\%$	5	100	3.60	4.40	0.60	0.32	250	MLG0603S6N8HT000
6.8	$\pm 5\%$	5	100	3.60	4.40	0.60	0.32	250	MLG0603S6N8JT000
7.5	$\pm 3\%$	5	100	4.20	5.30	0.70	0.43	200	MLG0603S7N5HT000
7.5	$\pm 5\%$	5	100	4.20	5.30	0.70	0.43	200	MLG0603S7N5JT000
8.2	$\pm 3\%$	5	100	3.80	4.50	0.70	0.45	200	MLG0603S8N2HT000
8.2	$\pm 5\%$	5	100	3.80	4.50	0.70	0.45	200	MLG0603S8N2JT000
9.1	$\pm 3\%$	5	100	3.40	4.90	0.80	0.51	200	MLG0603S9N1HT000
9.1	$\pm 5\%$	5	100	3.40	4.90	0.80	0.51	200	MLG0603S9N1JT000
10	$\pm 3\%$	5	100	3.20	4.10	0.80	0.53	200	MLG0603S10NJT000
10	$\pm 5\%$	5	100	3.20	4.10	0.80	0.53	200	MLG0603S10NJT000
11	$\pm 3\%$	6	100	3.00	3.70	0.80	0.53	200	MLG0603S11NHT000
11	$\pm 5\%$	6	100	3.00	3.70	0.80	0.53	200	MLG0603S11NJT000
12	$\pm 3\%$	6	100	2.80	3.60	0.90	0.63	180	MLG0603S12NHT000
12	$\pm 5\%$	6	100	2.80	3.60	0.90	0.63	180	MLG0603S12NJT000
13	$\pm 3\%$	6	100	2.70	3.40	0.90	0.60	180	MLG0603S13NHT000
13	$\pm 5\%$	6	100	2.70	3.40	0.90	0.60	180	MLG0603S13NJT000
15	$\pm 3\%$	6	100	2.50	3.30	1.10	0.69	180	MLG0603S15NHT000
15	$\pm 5\%$	6	100	2.50	3.30	1.10	0.69	180	MLG0603S15NJT000
16	$\pm 3\%$	6	100	2.30	3.00	1.10	0.70	180	MLG0603S16NHT000
16	$\pm 5\%$	6	100	2.30	3.00	1.10	0.70	180	MLG0603S16NJT000
18	$\pm 3\%$	6	100	2.20	2.80	1.20	0.78	150	MLG0603S18NHT000
18	$\pm 5\%$	6	100	2.20	2.80	1.20	0.78	150	MLG0603S18NJT000
20	$\pm 3\%$	6	100	2.10	2.60	1.20	0.75	150	MLG0603S20NHT000
20	$\pm 5\%$	6	100	2.10	2.60	1.20	0.75	150	MLG0603S20NJT000

* Please contact us for information on inductance tolerance, G ($\pm 2\%$).

Measurement equipment

Measurement item	Product No.	Manufacturer
L, Q	4291B+16197A	Keysight Technologies
Self-resonant frequency	8720C	Keysight Technologies
DC resistance	Type-7561	Yokogawa

* Equivalent measurement equipment may be used.

MLG0603S type

CHARACTERISTICS SPECIFICATION TABLE

L (nH)	Q Tolerance	L, Q measuring frequency min. (MHz)	Self-resonant frequency		DC resistance		Rated current (mA)max.	Part No.*	
			(GHz)min.	(GHz)typ.	(Ω)max.	(Ω)typ.			
22	$\pm 3\%$	6	100	2.00	2.50	1.20	0.88	150	MLG0603S22NHT000
22	$\pm 5\%$	6	100	2.00	2.50	1.20	0.88	150	MLG0603S22NJT000
24	$\pm 3\%$	6	100	1.90	2.30	1.30	0.90	150	MLG0603S24NHT000
24	$\pm 5\%$	6	100	1.90	2.30	1.30	0.90	150	MLG0603S24NJT000
27	$\pm 3\%$	6	100	1.80	2.20	1.50	1.00	100	MLG0603S27NHT000
27	$\pm 5\%$	6	100	1.80	2.20	1.50	1.00	100	MLG0603S27NJT000
30	$\pm 3\%$	6	100	1.60	2.00	1.60	0.95	100	MLG0603S30NHT000
30	$\pm 5\%$	6	100	1.60	2.00	1.60	0.95	100	MLG0603S30NJT000
33	$\pm 3\%$	6	100	1.60	2.00	1.80	1.20	100	MLG0603S33NHT000
33	$\pm 5\%$	6	100	1.60	2.00	1.80	1.20	100	MLG0603S33NJT000
36	$\pm 3\%$	6	100	1.50	1.80	2.00	1.68	50	MLG0603S36NHT000
36	$\pm 5\%$	6	100	1.50	1.80	2.00	1.68	50	MLG0603S36NJT000
39	$\pm 3\%$	6	100	1.40	1.60	2.00	1.40	50	MLG0603S39NHT000
39	$\pm 5\%$	6	100	1.40	1.60	2.00	1.40	50	MLG0603S39NJT000
43	$\pm 3\%$	6	100	1.30	1.60	2.20	1.91	50	MLG0603S43NHT000
43	$\pm 5\%$	6	100	1.30	1.60	2.20	1.91	50	MLG0603S43NJT000
47	$\pm 3\%$	6	100	1.30	1.50	2.20	1.48	50	MLG0603S47NHT000
47	$\pm 5\%$	6	100	1.30	1.50	2.20	1.48	50	MLG0603S47NJT000
51	$\pm 3\%$	5	100	1.20	1.50	2.80	1.98	50	MLG0603S51NHT000
51	$\pm 5\%$	5	100	1.20	1.50	2.80	1.98	50	MLG0603S51NJT000
56	$\pm 3\%$	5	100	1.20	1.40	3.20	2.11	50	MLG0603S56NHT000
56	$\pm 5\%$	5	100	1.20	1.40	3.20	2.11	50	MLG0603S56NJT000
62	$\pm 3\%$	5	100	1.10	1.30	3.30	2.22	50	MLG0603S62NHT000
62	$\pm 5\%$	5	100	1.10	1.30	3.30	2.22	50	MLG0603S62NJT000
68	$\pm 3\%$	5	100	1.05	1.24	3.50	2.40	50	MLG0603S68NHT000
68	$\pm 5\%$	5	100	1.05	1.24	3.50	2.40	50	MLG0603S68NJT000
75	$\pm 3\%$	5	100	0.95	1.17	3.80	2.67	50	MLG0603S75NHT000
75	$\pm 5\%$	5	100	0.95	1.17	3.80	2.67	50	MLG0603S75NJT000
82	$\pm 3\%$	5	100	0.90	1.08	4.00	2.80	50	MLG0603S82NHT000
82	$\pm 5\%$	5	100	0.90	1.08	4.00	2.80	50	MLG0603S82NJT000
91	$\pm 3\%$	5	100	0.77	0.94	4.30	2.97	50	MLG0603S91NHT000
91	$\pm 5\%$	5	100	0.77	0.94	4.30	2.97	50	MLG0603S91NJT000
100	$\pm 3\%$	5	100	0.77	0.94	4.50	3.13	50	MLG0603SR10HT000
100	$\pm 5\%$	5	100	0.77	0.94	4.50	3.13	50	MLG0603SR10JT000
110	$\pm 3\%$	5	100	0.77	0.94	6.50	5.24	50	MLG0603SR11HT000
110	$\pm 5\%$	5	100	0.77	0.94	6.50	5.24	50	MLG0603SR11JT000
120	$\pm 3\%$	5	100	0.70	0.88	7.00	5.53	50	MLG0603SR12HT000
120	$\pm 5\%$	5	100	0.70	0.88	7.00	5.53	50	MLG0603SR12JT000
130	$\pm 3\%$	5	100	0.67	0.84	7.30	5.68	50	MLG0603SR13HT000
130	$\pm 5\%$	5	100	0.67	0.84	7.30	5.68	50	MLG0603SR13JT000
150	$\pm 3\%$	5	100	0.64	0.77	8.00	6.24	50	MLG0603SR15HT000
150	$\pm 5\%$	5	100	0.64	0.77	8.00	6.24	50	MLG0603SR15JT000
160	$\pm 3\%$	5	100	0.60	0.73	8.30	6.67	50	MLG0603SR16HT000
160	$\pm 5\%$	5	100	0.60	0.73	8.30	6.67	50	MLG0603SR16JT000
180	$\pm 3\%$	5	100	0.56	0.68	8.50	6.99	50	MLG0603SR18HT000
180	$\pm 5\%$	5	100	0.56	0.68	8.50	6.99	50	MLG0603SR18JT000

* Please contact us for information on inductance tolerance, G ($\pm 2\%$).

Measurement equipment

Measurement item	Product No.	Manufacturer
L, Q	4291B+16197A	Keysight Technologies
Self-resonant frequency	8720C	Keysight Technologies
DC resistance	Type-7561	Yokogawa

* Equivalent measurement equipment may be used.

MLG0603S type

L, Q FREQUENCY CHARACTERISTICS TABLE

L(nH)typ.					Q typ.					Part No.*
500MHz	800MHz	1.8GHz	2.0GHz	2.4GHz	500MHz	800MHz	1.8GHz	2.0GHz	2.4GHz	
0.3	0.3	0.3	0.3	0.3	14min.	18min.	29min.	32min.	35min.	MLG0603S0N3BT000
0.3	0.3	0.3	0.3	0.3	14min.	18min.	29min.	32min.	35min.	MLG0603S0N3CT000
0.4	0.4	0.4	0.4	0.4	14min.	18min.	29min.	32min.	35min.	MLG0603S0N4BT000
0.4	0.4	0.4	0.4	0.4	14min.	18min.	29min.	32min.	35min.	MLG0603S0N4CT000
0.5	0.5	0.5	0.5	0.5	14	18	29	32	35	MLG0603S0N5BT000
0.5	0.5	0.5	0.5	0.5	14	18	29	32	35	MLG0603S0N5CT000
0.6	0.6	0.5	0.5	0.5	16	20	33	34	39	MLG0603S0N6BT000
0.6	0.6	0.5	0.5	0.5	16	20	33	34	39	MLG0603S0N6CT000
0.7	0.6	0.6	0.6	0.6	16	21	33	35	39	MLG0603S0N7BT000
0.7	0.6	0.6	0.6	0.6	16	21	33	35	39	MLG0603S0N7CT000
0.7	0.7	0.7	0.7	0.7	15	20	32	34	38	MLG0603S0N8BT000
0.7	0.7	0.7	0.7	0.7	15	20	32	34	38	MLG0603S0N8CT000
0.8	0.8	0.8	0.8	0.8	15	19	30	32	35	MLG0603S0N9BT000
0.8	0.8	0.8	0.8	0.8	15	19	30	32	35	MLG0603S0N9CT000
0.9	0.9	0.9	0.9	0.9	14	18	29	30	34	MLG0603S1N0BT000
0.9	0.9	0.9	0.9	0.9	14	18	29	30	34	MLG0603S1N0CT000
0.9	0.9	0.9	0.9	0.9	14	18	29	30	34	MLG0603S1N0ST000
1.0	1.0	1.0	1.0	1.0	14	19	29	31	34	MLG0603S1N1BT000
1.0	1.0	1.0	1.0	1.0	14	19	29	31	34	MLG0603S1N1CT000
1.0	1.0	1.0	1.0	1.0	14	19	29	31	34	MLG0603S1N1ST000
1.1	1.1	1.1	1.1	1.1	14	18	29	30	34	MLG0603S1N2BT000
1.1	1.1	1.1	1.1	1.1	14	18	29	30	34	MLG0603S1N2CT000
1.1	1.1	1.1	1.1	1.1	14	18	29	30	34	MLG0603S1N2ST000
1.2	1.2	1.2	1.2	1.2	14	18	29	30	33	MLG0603S1N3BT000
1.2	1.2	1.2	1.2	1.2	14	18	29	30	33	MLG0603S1N3CT000
1.2	1.2	1.2	1.2	1.2	14	18	29	30	33	MLG0603S1N3ST000
1.4	1.4	1.4	1.4	1.4	15	19	29	30	34	MLG0603S1N5BT000
1.4	1.4	1.4	1.4	1.4	15	19	29	30	34	MLG0603S1N5CT000
1.4	1.4	1.4	1.4	1.4	15	19	29	30	34	MLG0603S1N5ST000
1.5	1.5	1.5	1.5	1.5	14	18	29	30	33	MLG0603S1N6BT000
1.5	1.5	1.5	1.5	1.5	14	18	29	30	33	MLG0603S1N6CT000
1.5	1.5	1.5	1.5	1.5	14	18	29	30	33	MLG0603S1N6ST000
1.7	1.7	1.7	1.7	1.7	15	19	29	30	33	MLG0603S1N8BT000
1.7	1.7	1.7	1.7	1.7	15	19	29	30	33	MLG0603S1N8CT000
1.7	1.7	1.7	1.7	1.7	15	19	29	30	33	MLG0603S1N8ST000
1.9	1.9	1.9	1.9	1.9	14	18	28	29	32	MLG0603S2N0BT000
1.9	1.9	1.9	1.9	1.9	14	18	28	29	32	MLG0603S2N0CT000
1.9	1.9	1.9	1.9	1.9	14	18	28	29	32	MLG0603S2N0ST000
2.1	2.0	2.1	2.1	2.1	14	18	27	28	31	MLG0603S2N2BT000
2.1	2.0	2.1	2.1	2.1	14	18	27	28	31	MLG0603S2N2CT000
2.1	2.0	2.1	2.1	2.1	14	18	27	28	31	MLG0603S2N2ST000
2.2	2.2	2.2	2.3	2.3	14	18	27	29	32	MLG0603S2N4BT000
2.2	2.2	2.2	2.3	2.3	14	18	27	29	32	MLG0603S2N4CT000
2.2	2.2	2.2	2.3	2.3	14	18	27	29	32	MLG0603S2N4ST000
2.5	2.5	2.6	2.6	2.7	15	19	28	29	31	MLG0603S2N7BT000
2.5	2.5	2.6	2.6	2.7	15	19	28	29	31	MLG0603S2N7CT000
2.5	2.5	2.6	2.6	2.7	15	19	28	29	31	MLG0603S2N7ST000

* Please contact us for information on inductance tolerance, G ($\pm 2\%$).

Measurement equipment

Product No.	Manufacturer
4291B+16197A	Keysight Technologies

* Equivalent measurement equipment may be used.

MLG0603S type

L, Q FREQUENCY CHARACTERISTICS TABLE

L(nH)typ.					Q typ.					Part No.*
500MHz	800MHz	1.8GHz	2.0GHz	2.4GHz	500MHz	800MHz	1.8GHz	2.0GHz	2.4GHz	
2.8	2.8	2.9	2.9	3.0	15	19	29	31	33	MLG0603S3N0BT000
2.8	2.8	2.9	2.9	3.0	15	19	29	31	33	MLG0603S3N0CT000
2.8	2.8	2.9	2.9	3.0	15	19	29	31	33	MLG0603S3N0ST000
3.1	3.1	3.2	3.3	3.4	15	19	28	29	31	MLG0603S3N3BT000
3.1	3.1	3.2	3.3	3.4	15	19	28	29	31	MLG0603S3N3CT000
3.1	3.1	3.2	3.3	3.4	15	19	28	29	31	MLG0603S3N3ST000
3.4	3.4	3.5	3.6	3.7	14	18	26	27	29	MLG0603S3N6BT000
3.4	3.4	3.5	3.6	3.7	14	18	26	27	29	MLG0603S3N6CT000
3.4	3.4	3.5	3.6	3.7	14	18	26	27	29	MLG0603S3N6ST000
3.7	3.7	3.8	3.9	4.1	15	19	29	29	32	MLG0603S3N9BT000
3.7	3.7	3.8	3.9	4.1	15	19	29	29	32	MLG0603S3N9CT000
3.7	3.7	3.8	3.9	4.1	15	19	29	29	32	MLG0603S3N9ST000
4.1	4.1	4.3	4.4	4.6	14	18	27	27	29	MLG0603S4N3HT000
4.1	4.1	4.3	4.4	4.6	14	18	27	27	29	MLG0603S4N3ST000
4.4	4.4	4.8	4.9	5.2	15	20	28	29	30	MLG0603S4N7HT000
4.4	4.4	4.8	4.9	5.2	15	20	28	29	30	MLG0603S4N7ST000
4.8	4.8	5.1	5.3	5.6	14	18	25	26	27	MLG0603S5N1HT000
4.8	4.8	5.1	5.3	5.6	14	18	25	26	27	MLG0603S5N1ST000
5.3	5.3	5.7	5.9	6.4	16	20	27	28	29	MLG0603S5N6HT000
5.3	5.3	5.7	5.9	6.4	16	20	27	28	29	MLG0603S5N6ST000
5.9	5.9	6.5	6.8	7.5	15	18	25	25	26	MLG0603S6N2HT000
5.9	5.9	6.5	6.8	7.5	15	18	25	25	26	MLG0603S6N2ST000
6.4	6.5	7.4	7.8	8.7	15	19	26	26	25	MLG0603S6N8HT000
6.4	6.5	7.4	7.8	8.7	15	19	26	26	25	MLG0603S6N8JT000
7.1	7.1	7.8	8.0	8.7	14	18	25	26	26	MLG0603S7N5HT000
7.1	7.1	7.8	8.0	8.7	14	18	25	26	26	MLG0603S7N5JT000
7.8	7.8	8.8	9.3	10.4	15	18	24	24	24	MLG0603S8N2HT000
7.8	7.8	8.8	9.3	10.4	15	18	24	24	24	MLG0603S8N2JT000
8.6	8.6	9.8	10.3	11.5	14	17	22	22	22	MLG0603S9N1HT000
8.6	8.6	9.8	10.3	11.5	14	17	22	22	22	MLG0603S9N1JT000
10	10	12	12	15	15	18	23	22	21	MLG0603S10NHT000
10	10	12	12	15	15	18	23	22	21	MLG0603S10NJT000
10	11	13	14	16	15	18	22	22	20	MLG0603S11NHT000
10	11	13	14	16	15	18	22	22	20	MLG0603S11NJT000
11	12	14	15	19	16	19	24	23	20	MLG0603S12NHT000
11	12	14	15	19	16	19	24	23	20	MLG0603S12NJT000
12	13	16	17	22	14	16	19	18	15	MLG0603S13NHT000
12	13	16	17	22	14	16	19	18	15	MLG0603S13NJT000
14	15	20	23	33	15	19	20	18	14	MLG0603S15NHT000
14	15	20	23	33	15	19	20	18	14	MLG0603S15NJT000
15	16	22	25	37	14	16	16	15	11	MLG0603S16NHT000
15	16	22	25	37	14	16	16	15	11	MLG0603S16NJT000
17	18	28	35		14	17	15	13		MLG0603S18NHT000
17	18	28	35		14	17	15	13		MLG0603S18NJT000
19	20	32			13	16	14			MLG0603S20NHT000
19	20	32			13	16	14			MLG0603S20NJT000
21	23	40			15	17	13			MLG0603S22NHT000

* Please contact us for information on inductance tolerance, G ($\pm 2\%$).

Measurement equipment

Product No.	Manufacturer
4291B+16197A	Keysight Technologies

* Equivalent measurement equipment may be used.

MLG0603S type

L, Q FREQUENCY CHARACTERISTICS TABLE

L(nH)typ.					Q typ.					Part No.*
500MHz	800MHz	1.8GHz	2.0GHz	2.4GHz	500MHz	800MHz	1.8GHz	2.0GHz	2.4GHz	
21	23	40			15	17	13			MLG0603S22NJT000
23	24	45			13	15	13			MLG0603S24NHT000
23	24	45			13	15	13			MLG0603S24NJT000
27	29				15	17				MLG0603S27NHT000
27	29				15	17				MLG0603S27NJT000
29	32				13	15				MLG0603S30NHT000
29	32				13	15				MLG0603S30NJT000
33	36				14	16				MLG0603S33NHT000
33	36				14	16				MLG0603S33NJT000
36	40				14	15				MLG0603S36NHT000
36	40				14	15				MLG0603S36NJT000
40	47				13	14				MLG0603S39NHT000
40	47				13	14				MLG0603S39NJT000
44	53				14	14				MLG0603S43NHT000
44	53				14	14				MLG0603S43NJT000
49	60				13	13				MLG0603S47NHT000
49	60				13	13				MLG0603S47NJT000
52	64				11	11				MLG0603S51NHT000
52	64				11	11				MLG0603S51NJT000
59	77				12	11				MLG0603S56NHT000
59	77				12	11				MLG0603S56NJT000
66	88				11	10				MLG0603S62NHT000
66	88				11	10				MLG0603S62NJT000
74	104				13	11				MLG0603S68NHT000
74	104				13	11				MLG0603S68NJT000
82	119				10	8				MLG0603S75NHT000
82	119				10	8				MLG0603S75NJT000
96	161				12	8				MLG0603S82NHT000
96	161				12	8				MLG0603S82NJT000
109					9					MLG0603S91NHT000
109					9					MLG0603S91NJT000
129					11					MLG0603SR10HT000
129					11					MLG0603SR10JT000
134					10					MLG0603SR11HT000
134					10					MLG0603SR11JT000
156					9					MLG0603SR12HT000
156					9					MLG0603SR12JT000
172					8					MLG0603SR13HT000
172					8					MLG0603SR13JT000
223					7					MLG0603SR15HT000
223					7					MLG0603SR15JT000
238					7					MLG0603SR16HT000
238					7					MLG0603SR16JT000
318					6					MLG0603SR18HT000
318					6					MLG0603SR18JT000

* Please contact us for information on inductance tolerance, G ($\pm 2\%$).

Measurement equipment

Product No.	Manufacturer
4291B+16197A	Keysight Technologies

* Equivalent measurement equipment may be used.

MLG0603S type

L FREQUENCY CHARACTERISTICS (EXAMPLE)

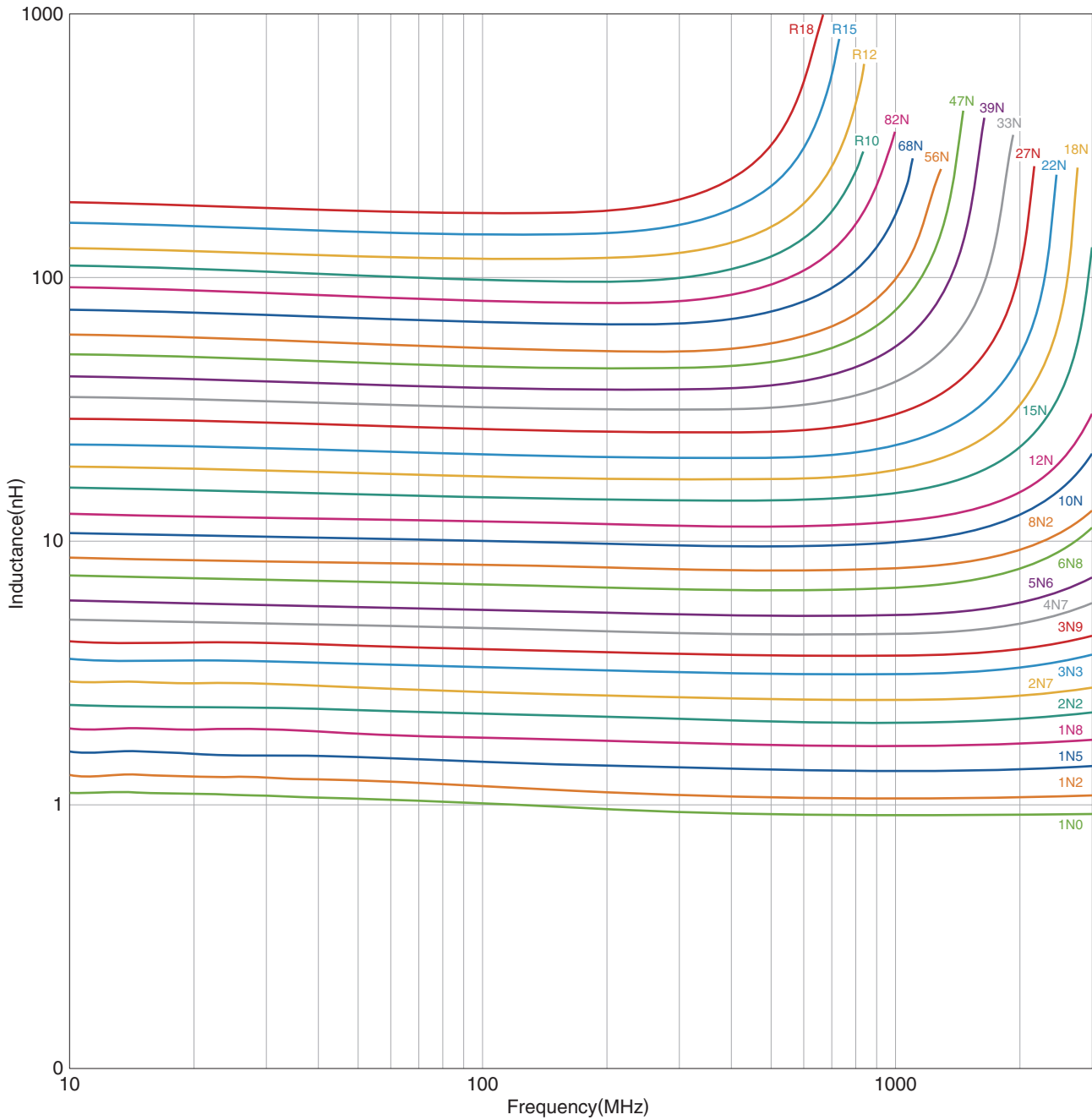

Measurement equipment

Product No.	Manufacturer
E4991A +16197A	Keysight Technologies

* Equivalent measurement equipment may be used.

MLG0603S type

Q FREQUENCY CHARACTERISTICS (EXAMPLE)

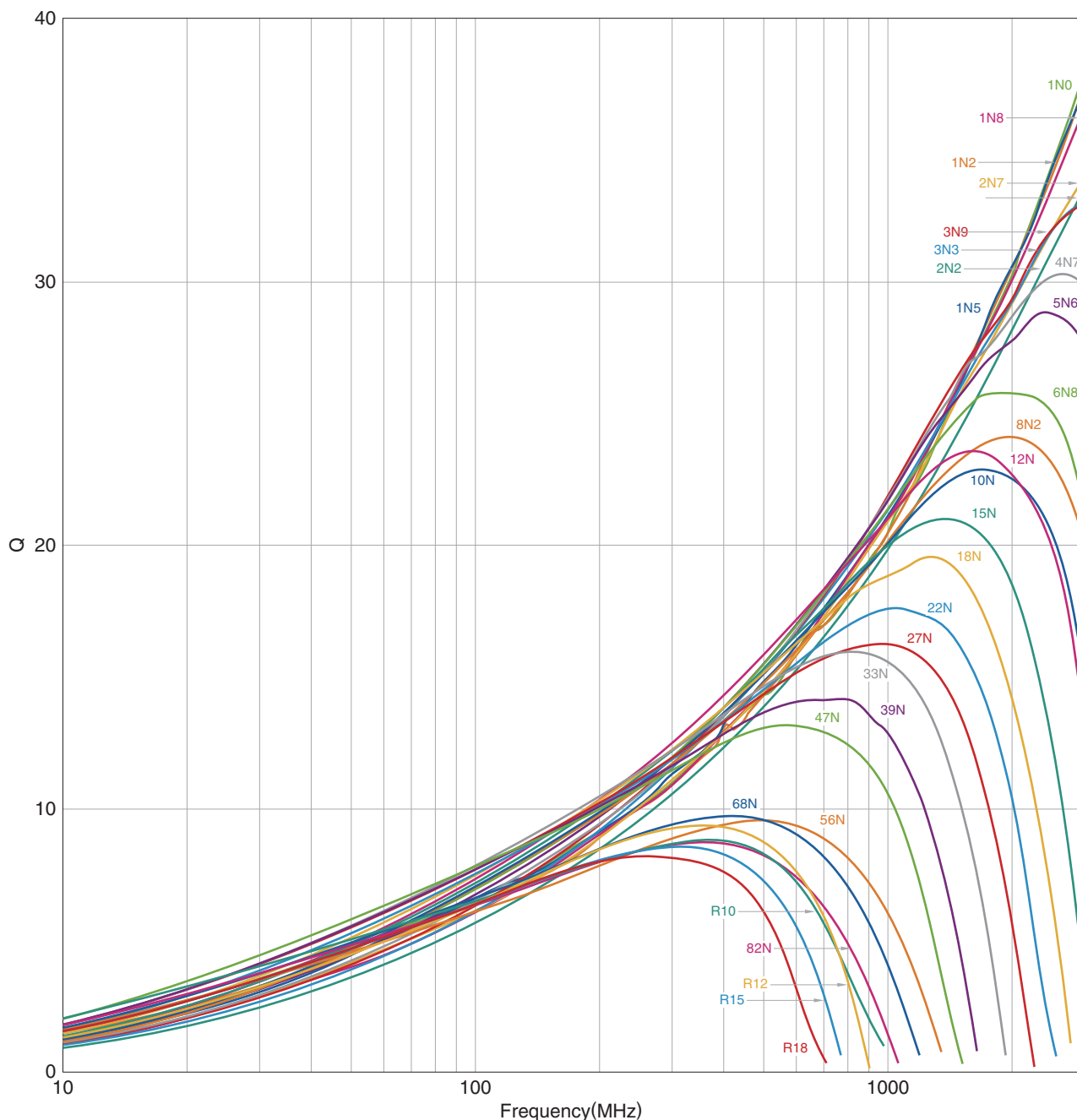

Measurement equipment

Product No.	Manufacturer
E4991A +16197A	Keysight Technologies

* Equivalent measurement equipment may be used.

MLG0603S type

SHAPE & DIMENSIONS

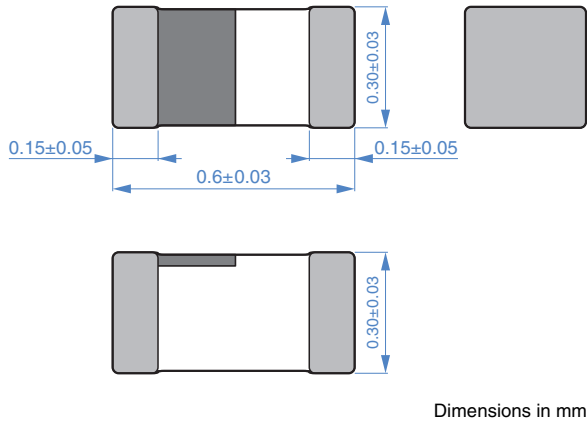

PACKAGING STYLE

REEL DIMENSIONS

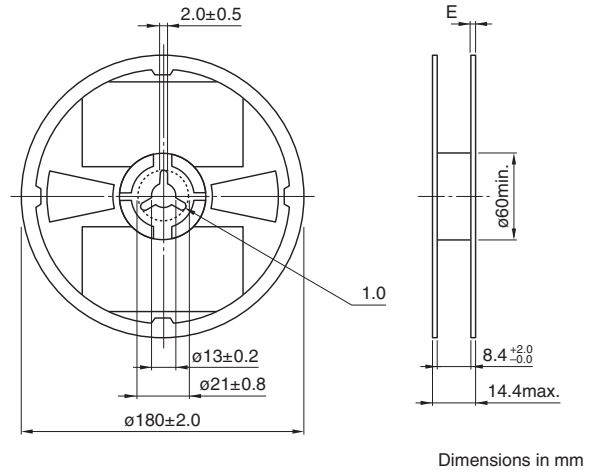

RECOMMENDED LAND PATTERN

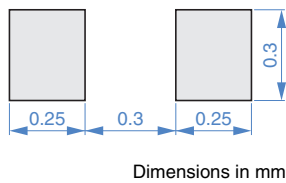

TAPE DIMENSIONS

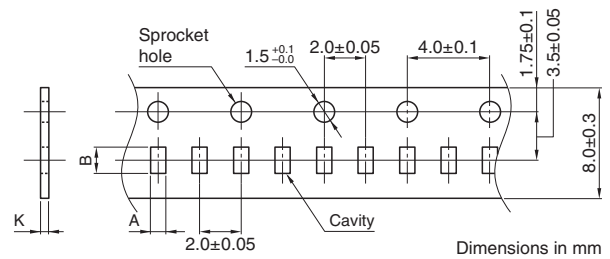

RECOMMENDED REFLOW PROFILE

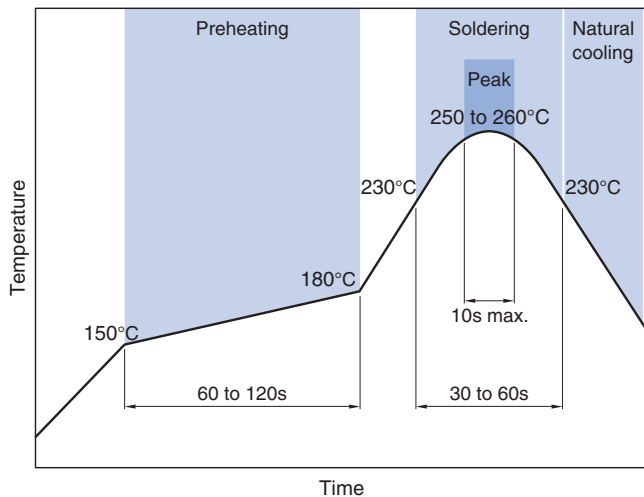

Type	A	B	K
MLG0603S	0.38±0.05	0.68±0.05	0.5 max.

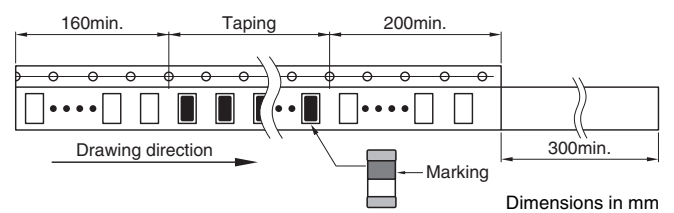

PACKAGE QUANTITY

Package quantity	15000 pcs/reel
------------------	----------------

TEMPERATURE RANGE, INDIVIDUAL WEIGHT

Operating temperature range	Storage temperature range*	Individual weight
-55 to +125 °C	-55 to +125 °C	0.2 mg

* The storage temperature range is for after the assembly.

REMINDERS FOR USING THESE PRODUCTS

Before using these products, be sure to request the delivery specifications.

SAFETY REMINDERS

Please pay sufficient attention to the warnings for safe designing when using this products.

REMINDERS

- The storage period is within 12 months. Be sure to follow the storage conditions (temperature: 5 to 40°C, humidity: 10 to 75% RH or less).
If the storage period elapses, the soldering of the terminal electrodes may deteriorate.
- Do not use or store in locations where there are conditions such as gas corrosion (salt, acid, alkali, etc.).
- Before soldering, be sure to preheat components.
The preheating temperature should be set so that the temperature difference between the solder temperature and chip temperature does not exceed 150°C.
- Soldering corrections after mounting should be within the range of the conditions determined in the specifications.
If overheated, a short circuit, performance deterioration, or lifespan shortening may occur.
- When embedding a printed circuit board where a chip is mounted to a set, be sure that residual stress is not given to the chip due to the overall distortion of the printed circuit board and partial distortion such as at screw tightening portions.
- Self heating (temperature increase) occurs when the power is turned ON, so the tolerance should be sufficient for the set thermal design.
- Carefully lay out the coil for the circuit board design of the non-magnetic shield type.
A malfunction may occur due to magnetic interference.
- Use a wrist band to discharge static electricity in your body through the grounding wire.
- Do not expose the products to magnets or magnetic fields.
- Do not use for a purpose outside of the contents regulated in the delivery specifications.
- The products listed on this catalog are intended for use in general electronic equipment (AV equipment, telecommunications equipment, home appliances, amusement equipment, computer equipment, personal equipment, office equipment, measurement equipment, industrial robots) under a normal operation and use condition.
The products are not designed or warranted to meet the requirements of the applications listed below, whose performance and/or quality require a more stringent level of safety or reliability, or whose failure, malfunction or trouble could cause serious damage to society, person or property.
If you intend to use the products in the applications listed below or if you have special requirements exceeding the range or conditions set forth in the each catalog, please contact us.

- (1) Aerospace/aviation equipment
- (2) Transportation equipment (cars, electric trains, ships, etc.)
- (3) Medical equipment
- (4) Power-generation control equipment
- (5) Atomic energy-related equipment
- (6) Seabed equipment
- (7) Transportation control equipment

- (8) Public information-processing equipment
- (9) Military equipment
- (10) Electric heating apparatus, burning equipment
- (11) Disaster prevention/crime prevention equipment
- (12) Safety equipment
- (13) Other applications that are not considered general-purpose applications

When designing your equipment even for general-purpose applications, you are kindly requested to take into consideration securing protection circuit/device or providing backup circuits in your equipment.