



GaAs MMIC SMT SINGLE BALANCED MIXER, 0.7 - 1.2 GHz

Typical Applications

The HMC277MS8 / HMC277MS8E is ideal for:

- Cellular / 3G Infrastructure
- Basestations & Repeaters
- GSM, CDMA & WCDMA
- Subscribers & Portables

Features

- Passive Topology
- LO / RF Isolation: 26 dB
- Input IP3: +21 dBm
- Low Conversion Loss: 9 dB
- RoHS Compliant MSOP-8 Package

Functional Diagram

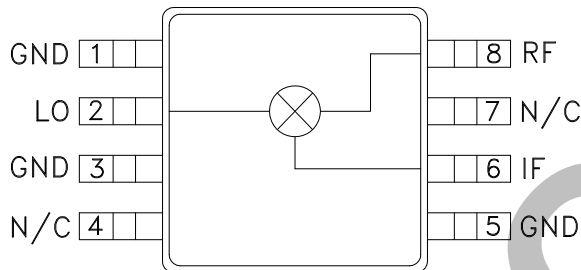

General Description

The HMC277MS8 & HMC277MS8E are general purpose single balanced mixers in 8 lead plastic surface mount Mini Small Outline Packages (MSOP). This passive MMIC mixer is constructed of GaAs Schottky diodes and a novel planar transformer balun on the chip. The HMC277MS8(E) requires no external matching components, and is ideal for upconverter and downconverter applications. The RF port is balanced via the MMIC balun while the LO port is connected directly to the diodes. This product is pin for pin compatible with the HMC272MS8(E) which operates from 1.7 to 3.0 GHz.

Electrical Specifications, $T_A = +25^\circ\text{C}$, LO = +13 dBm, IF = 100 MHz*

| Parameter | Min. | Typ. | Max. | Units |
|--------------------------|-----------|------|------|-------|
| Frequency Range, RF & LO | 0.7 - 1.2 | | | GHz |
| Frequency Range, IF | DC - 0.3 | | | GHz |
| Conversion Loss | | 9 | 10.5 | dB |
| Noise Figure (SSB) | | 9 | 10.5 | dB |
| LO to RF Isolation | 20 | 26 | | dB |
| LO to IF Isolation | 8 | 12 | | dB |
| IP3 (Input) | 17 | 21 | | dBm |
| 1 dB Compression (Input) | 9 | 12 | | dBm |

*Unless otherwise noted, all measurements performed as a downconverter with low side LO.



GaAs MMIC SMT SINGLE BALANCED MIXER, 0.7 - 1.2 GHz

Conversion Gain vs. Temperature @ LO = +13 dBm

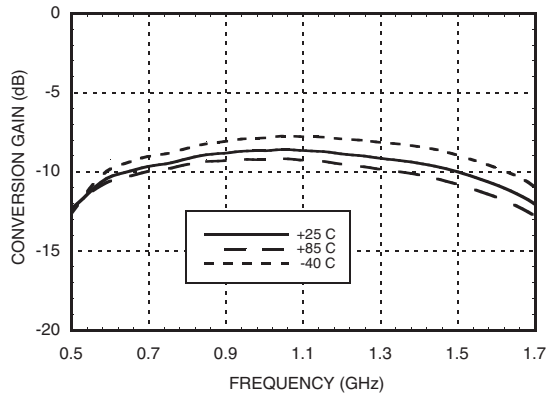

Isolation @ LO = +13 dBm

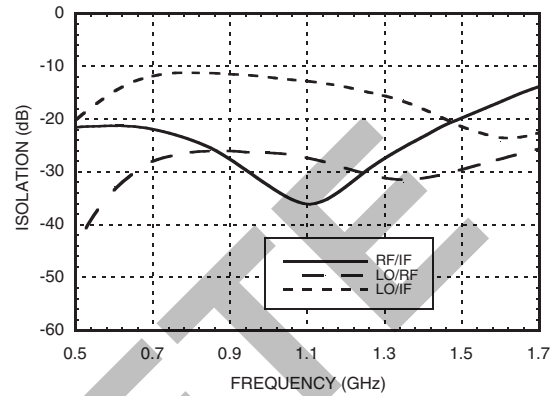

Conversion Gain vs. LO Drive

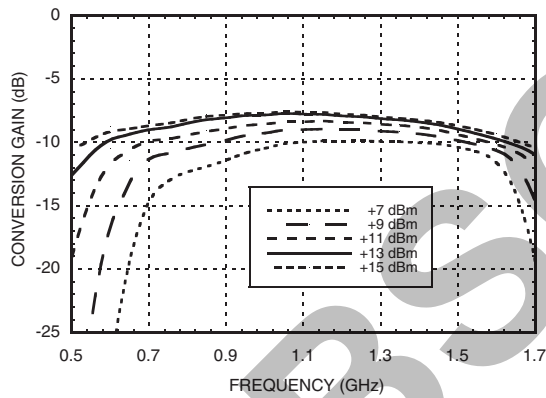

Return Loss @ LO = +13 dBm

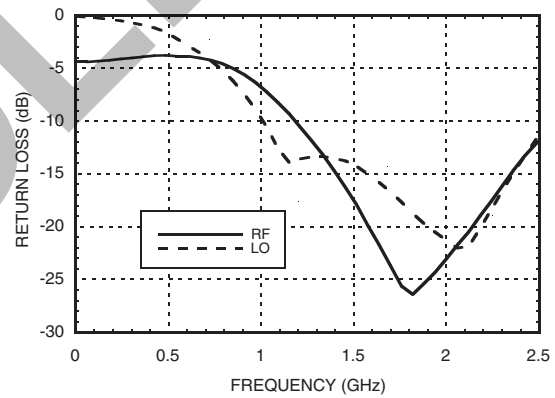

IF Bandwidth & IF Return Loss @ LO = +13 dBm

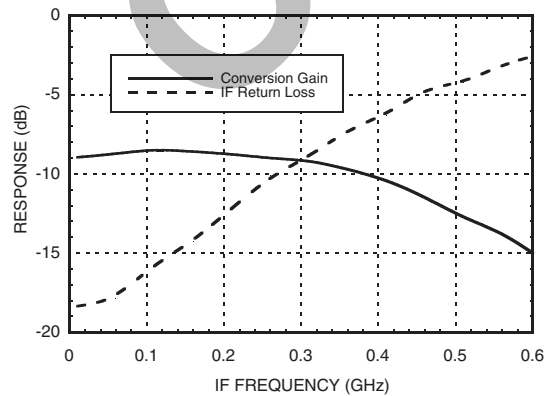

P1dB vs. Temperature @ LO = +13 dBm

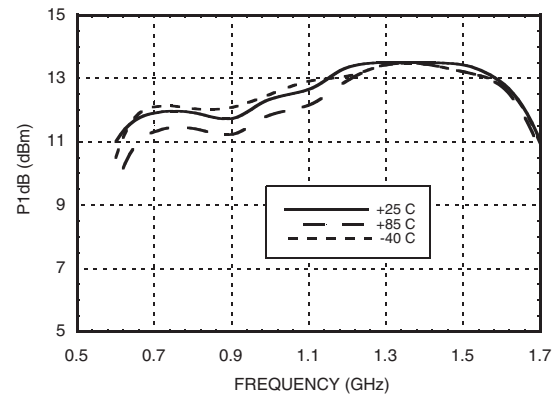

Information furnished by Analog Devices is believed to be accurate and reliable. However, no responsibility is assumed by Analog Devices for its use, nor for any infringements of patents or other rights of third parties that may result from its use. Specifications subject to change without notice. No license is granted by implication or otherwise under any patent or patent rights of Analog Devices. Trademarks and registered trademarks are the property of their respective owners.

For price, delivery, and to place orders: Analog Devices, Inc., One Technology Way, P.O. Box 9106, Norwood, MA 02062-9106 Phone: 781-329-4700 • Order online at www.analog.com Application Support: Phone: 1-800-ANALOG-D



GaAs MMIC SMT SINGLE BALANCED MIXER, 0.7 - 1.2 GHz

Input IP3 vs. LO Drive

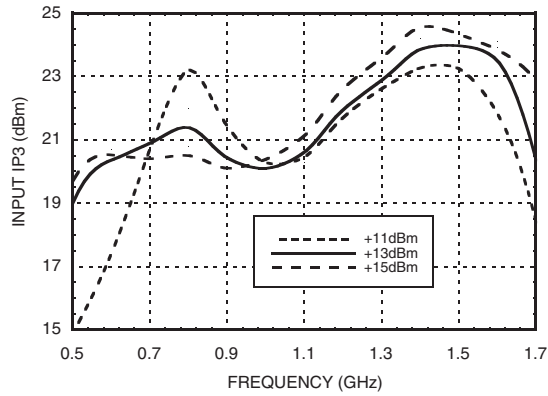

Input IP3 vs. Temperature @ LO = +13 dBm

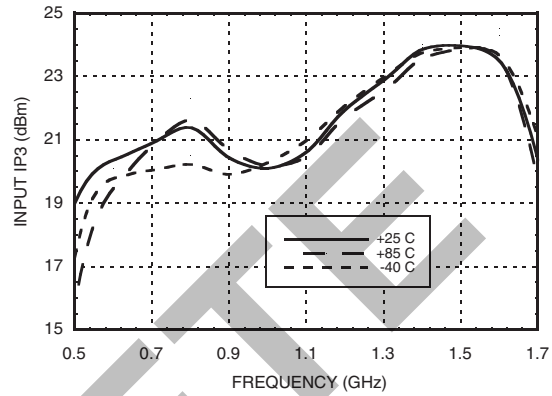

Input IP2 vs. LO Drive

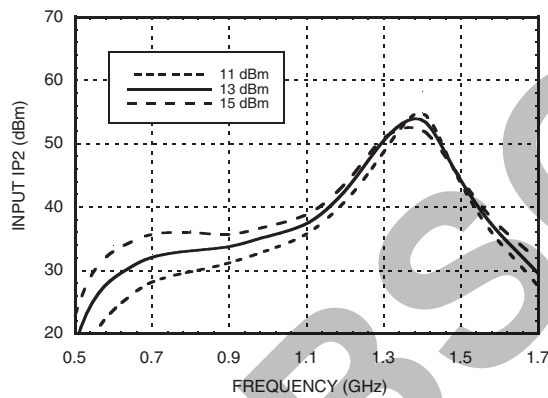

Input IP2 vs. Temperature @ LO = +13 dBm

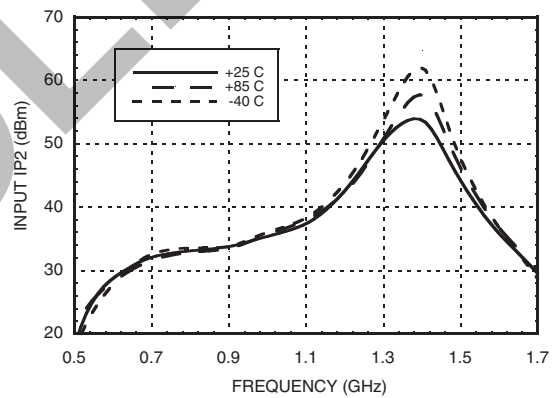

MxN Spurious Outputs

| mRF | nLO | | | | |
|-----|-----|-----|----|----|----|
| | 0 | 1 | 2 | 3 | 4 |
| 0 | xx | -15 | 4 | 25 | 19 |
| 1 | 19 | 0 | 36 | 38 | 36 |
| 2 | 44 | 49 | 52 | 40 | 63 |
| 3 | 69 | 83 | 87 | 62 | 74 |
| 4 | 95 | 90 | 90 | 93 | 78 |

RF = 0.96 GHz @ -5 dBm
 LO = 0.8 GHz @ +13 dBm
 All values in dBc relative to the IF

Harmonics of LO

| LO Frequency (GHz) | nLO Spur at RF Port | | | |
|--------------------|---------------------|----|----|----|
| | 1 | 2 | 3 | 4 |
| 0.5 | 31 | 19 | 56 | 35 |
| 0.7 | 26 | 14 | 46 | 40 |
| 0.9 | 26 | 14 | 49 | 40 |
| 1.1 | 29 | 20 | 48 | 39 |
| 1.3 | 31 | 25 | 49 | 39 |
| 1.5 | 27 | 29 | 58 | 42 |

LO = +13 dBm
 Values in dBc below input LO level measured at the RF port.

Information furnished by Analog Devices is believed to be accurate and reliable. However, no responsibility is assumed by Analog Devices for its use, nor for any infringements of patents or other rights of third parties that may result from its use. Specifications subject to change without notice. No license is granted by implication or otherwise under any patent or patent rights of Analog Devices. Trademarks and registered trademarks are the property of their respective owners.

For price, delivery, and to place orders: Analog Devices, Inc., One Technology Way, P.O. Box 9106, Norwood, MA 02062-9106 Phone: 781-329-4700 • Order online at www.analog.com Application Support: Phone: 1-800-ANALOG-D

GaAs MMIC SMT SINGLE BALANCED MIXER, 0.7 - 1.2 GHz



Absolute Maximum Ratings

| | |
|-----------------------|----------------|
| RF / IF Input | +13 dBm |
| LO Drive | +27 dBm |
| Storage Temperature | -65 to +150 °C |
| Operating Temperature | -40 to +85 °C |
| ESD Sensitivity (HBM) | Class 1A |



ELECTROSTATIC SENSITIVE DEVICE
OBSERVE HANDLING PRECAUTIONS

Outline Drawing

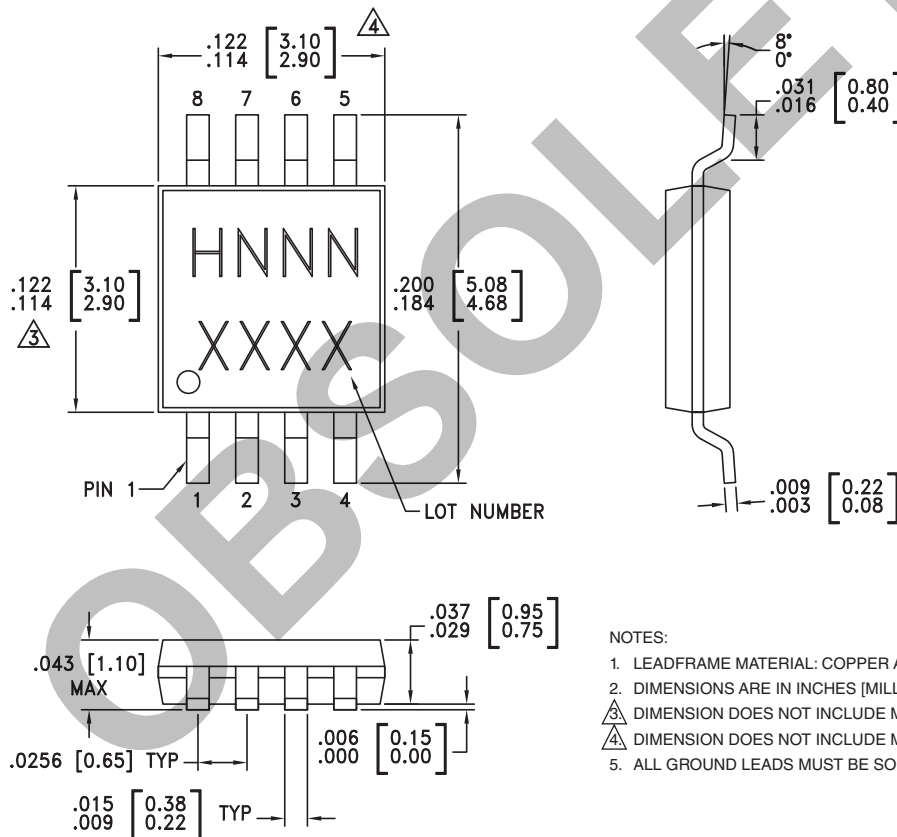

- NOTES:
- LEADFRAME MATERIAL: COPPER ALLOY
 - DIMENSIONS ARE IN INCHES [MILLIMETERS].
 - DIMENSION DOES NOT INCLUDE MOLDFLASH OF 0.15mm PER SIDE.
 - DIMENSION DOES NOT INCLUDE MOLDFLASH OF 0.25mm PER SIDE.
 - ALL GROUND LEADS MUST BE SOLDERED TO PCB RF GROUND.

Package Information

| Part Number | Package Body Material | Lead Finish | MSL Rating | Package Marking ^[3] |
|-------------|---|---------------|---------------------|--------------------------------|
| HMC277MS8 | Low Stress Injection Molding Plastic | Sn/Pb Solder | MSL1 ^[1] | H277 XXXX |
| HMC277MS8E | RoHS-compliant Low Stress Injection Molding Plastic | 100% matte Sn | MSL1 ^[2] | H277 XXXX |

[1] Max peak reflow temperature of 235 °C
 [2] Max peak reflow temperature of 260 °C
 [3] 4-Digit lot number XXXX

Information furnished by Analog Devices is believed to be accurate and reliable. However, no responsibility is assumed by Analog Devices for its use, nor for any infringements of patents or other rights of third parties that may result from its use. Specifications subject to change without notice. No license is granted by implication or otherwise under any patent or patent rights of Analog Devices. Trademarks and registered trademarks are the property of their respective owners.

For price, delivery, and to place orders: Analog Devices, Inc., One Technology Way, P.O. Box 9106, Norwood, MA 02062-9106 Phone: 781-329-4700 • Order online at www.analog.com Application Support: Phone: 1-800-ANALOG-D

**GaAs MMIC SMT SINGLE
BALANCED MIXER, 0.7 - 1.2 GHz**
Pin Descriptions

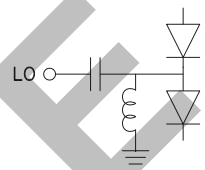
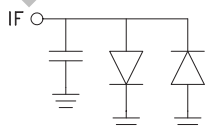
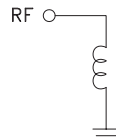
| Pin Number | Function | Description | Interface Schematic |
|------------|----------|---|--|
| 1, 3, 5 | GND | This pin must be connected to RF ground. |  |
| 2 | LO | This pin is AC coupled and matched to 50 Ohms. |  |
| 4, 7 | N/C | No connection required. These pins may be connected to RF/DC ground without affecting performance. | |
| 6 | IF | This pin is DC coupled. For applications not requiring operation to DC this port should be DC blocked externally using a series capacitor. Choose value of capacitor to pass IF frequency desired. For operation to DC, this pin must not sink/source more than 40 mA of current or failure may result. |  |
| 8 | RF | This pin is DC coupled and matched to 50 Ohms. |  |



Evaluation Circuit Board

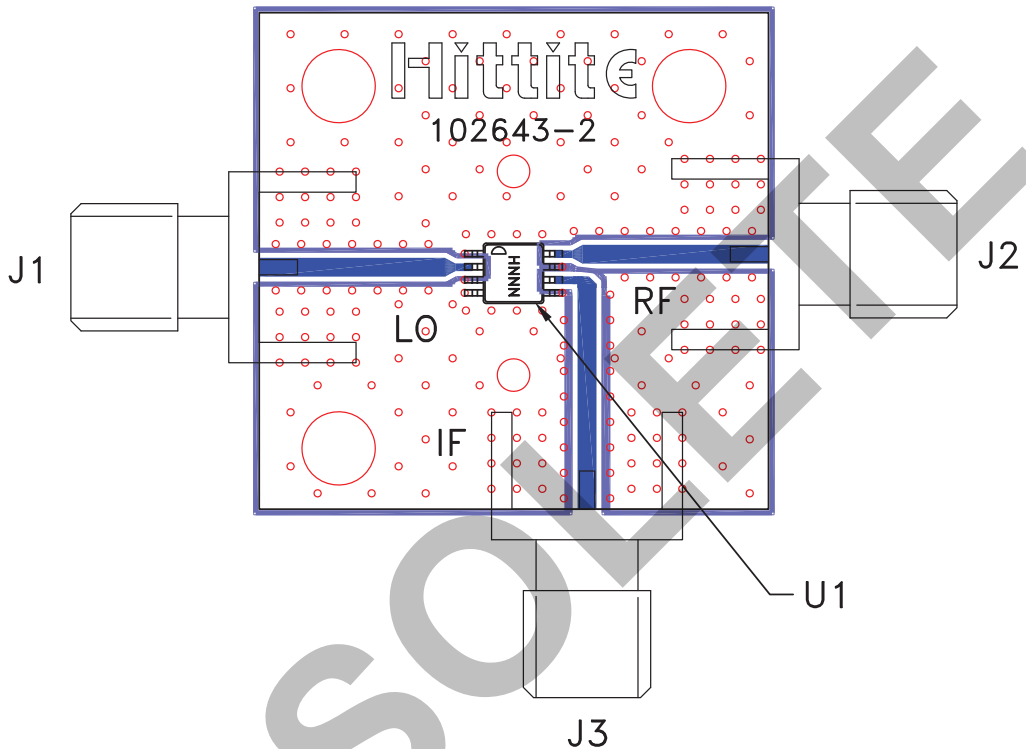

List of Materials for Evaluation PCB 115791 [1]

| Item | Description |
|---------|------------------------------|
| J1 - J3 | PCB Mount SMA RF Connector |
| U1 | HMC277MS8 / HMC272MS8E Mixer |
| PCB [2] | 102643 Evaluation Board |

[1] Reference this number when ordering complete evaluation PCB

[2] Circuit Board Material: Rogers 4350

The circuit board used in the final application should use RF circuit design techniques. Signal lines should have 50 ohm impedance while the package ground leads and exposed paddle should be connected directly to the ground plane similar to that shown. A sufficient number of via holes should be used to connect the top and bottom ground planes. The evaluation circuit board shown is available from Hittite upon request.

Information furnished by Analog Devices is believed to be accurate and reliable. However, no responsibility is assumed by Analog Devices for its use, nor for any infringements of patents or other rights of third parties that may result from its use. Specifications subject to change without notice. No license is granted by implication or otherwise under any patent or patent rights of Analog Devices. Trademarks and registered trademarks are the property of their respective owners.

For price, delivery, and to place orders: Analog Devices, Inc., One Technology Way, P.O. Box 9106, Norwood, MA 02062-9106 Phone: 781-329-4700 • Order online at www.analog.com Application Support: Phone: 1-800-ANALOG-D