

## Low Noise, High Speed Precision Operational Amplifiers

### FEATURES

- *Guaranteed*  $3.8\text{nV}/\sqrt{\text{Hz}}$  max 1kHz Noise
- *Guaranteed*  $5.5\text{nV}/\sqrt{\text{Hz}}$  max 10Hz Noise
- Very Low Peak-to-Peak Noise, 80nV Typical
- *Guaranteed*  $25\mu\text{V}$  max Offset Voltage
- *Guaranteed*  $0.6\mu\text{V}/^\circ\text{C}$  max Drift with Temperature
- *Guaranteed*  $11\text{V}/\mu\text{sec}$  min Slew Rate (OP-37)
- *Guaranteed* 1 Million min Voltage Gain

### APPLICATIONS

- Low Level Transducer Amplifiers
- Precision Threshold Detectors
- Tape Head Preamplifiers
- Microphone Preamplifiers
- Direct Coupled Audio Gain Stages

### DESCRIPTION

The OP-27/OP-37 series of operational amplifiers combine outstanding noise performance with excellent precision and high speed specifications. The wideband noise is only  $3\text{nV}/\sqrt{\text{Hz}}$ , and with the  $1/f$  noise corner at 2.7Hz, low noise is maintained for all low frequency instrumentation applications. Precision DC specifications match or exceed the best available op amps: offset voltage is  $10\mu\text{V}$ , drift with temperature and time are  $0.2\mu\text{V}/^\circ\text{C}$  and  $0.2\mu\text{V}/\text{month}$ , respectively; common mode rejection is 126dB, voltage gain is two million. The unity gain compensated OP-27 is an order of magnitude faster than other precision op amps. The decompensated OP-37 is even faster at a gain-bandwidth product of 63MHz and  $17\text{V}/\mu\text{sec}$  slew rate. These characteristics plus Linear Technology's advanced process and test techniques make the OP-27/37 an excellent choice for performance and reliability in all low noise, precision amplifier applications. In addition, Linear's OP-37 is completely latch-up free in high gain, large capacitive feedback configurations. The accurate, microvolt, low noise signal handling capabilities of the OP-27/37 are taken advantage of in the multiplexed thermocouple application shown.

For applications requiring higher performance, see the LT1007 and LT1037 data sheets.

#### Low Noise, Multiplexed Thermocouple Amplifier

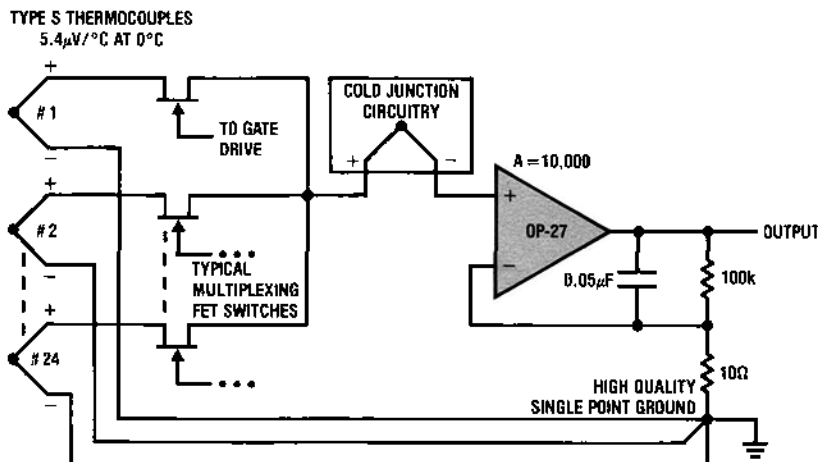

If 24 channels are multiplexed per second, and the output is required to settle to 0.1% accuracy, the amplifier's bandwidth cannot be limited to less than 30Hz. Yet the noise contribution of the OP-27 will still be only  $0.11\mu\text{Vp-p}$ , which is equivalent to an error of only  $0.02^\circ\text{C}$ .

#### 0.1Hz to 10Hz Noise

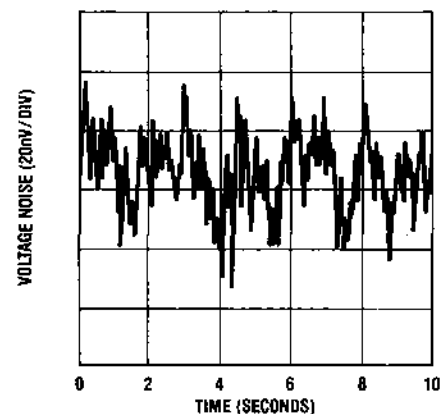

**ABSOLUTE MAXIMUM RATINGS**

Supply Voltage	± 22V
Internal Power Dissipation	500mW
Input Voltage	Equal to Supply Voltage
Output Short Circuit Duration	Indefinite
Differential Input Current (Note 8)	± 25mA
Lead Temperature (Soldering, 10 sec.)	300°C
Operating Temperature Range	
OP-27/OP-37 A, C	- 55°C to 125°C
OP-27/OP-37 E, G	- 25°C to 85°C
Junction Temperature Range	
OP-27/OP-37 A, C	- 55°C to 150°C
OP-27/OP-37 E, G	- 25°C to 125°C
Storage Temperature Range	
OP-27/OP-37 A, C, E, G	- 65°C to 150°C

**PACKAGE/ORDER INFORMATION**

TOP VIEW		ORDER PART NUMBER	
<p>METAL CAN H PACKAGE</p>		<b>OBSELETE PACKAGE</b>	
		OP-27AH	OP-37AH
<p>HERMETIC DIP J8 PACKAGE</p>		OP-27CH	OP-37CH
		OP-27EH	OP-37EH
<p>PLASTIC DIP N8 PACKAGE</p>		OP-27GH	OP-37GH
		OP-27AJ8	OP-37EJ8
		OP-27CJ8	OP-37GJ8
		OP-27EJ8	OP-27EN8
		OP-27GJ8	OP-27GN8
		OP-37AJ8	OP-37EN8
		OP-37CJ8	OP-37GN8

**ELECTRICAL CHARACTERISTICS**

$V_S = \pm 15V, T_A = 25^\circ C$ , unless otherwise noted.

SYMBOL	PARAMETER	CONDITIONS	OP-27A, E / OP-37A, E			OP-27C, G / OP-37C, G			UNITS
			MIN	TYP	MAX	MIN	TYP	MAX	
$V_{OS}$	Input Offset Voltage	(Note 1)		10	25		30	100	$\mu V$
$\frac{\Delta V_{OS}}{\Delta Time}$	Long Term Offset Voltage Stability	(Note 2)		0.2	1.0		0.4	2.0	$\mu V/ Mo$
$I_{OS}$	Input Offset Current			7	35		12	75	nA
$I_B$	Input Bias Current			± 10	± 40		± 15	± 80	nA
$e_n$	Input Noise Voltage	0.1Hz to 10Hz (Notes 3 and 5)		0.08	0.18		0.09	0.25	$\mu Vp-p$
	Input Noise Voltage Density	$f_o = 10Hz$ (Note 3) $f_o = 30Hz$ (Note 3) $f_o = 1000Hz$ (Note 3)		3.5 3.1 3.0	5.5 4.5 3.8		3.8 3.3 3.2	8.0 5.6 4.5	nV/ $\sqrt{Hz}$ nV/ $\sqrt{Hz}$ nV/ $\sqrt{Hz}$
$I_n$	Input Noise Current Density	$f_o = 10Hz$ (Notes 3 and 6) $f_o = 30Hz$ (Notes 3 and 6) $f_o = 1000Hz$ (Notes 3 and 6)		1.7 1.0 0.4	4.0 2.3 0.6		1.7 1.0 0.4	0.6	pA/ $\sqrt{Hz}$ pA/ $\sqrt{Hz}$ pA/ $\sqrt{Hz}$
	Input Resistance—Common Mode			3			2		G $\Omega$
	Input Voltage Range			± 11.0	± 12.3		± 11.0	± 12.3	V
CMRR	Common Mode Rejection Ratio	$V_{CM} = \pm 11V$		114	126		100	120	dB
PSRR	Power Supply Rejection Ratio	$V_S = \pm 4V$ to $\pm 18V$		100	120		94	118	dB
$A_{VOL}$	Large Signal Voltage Gain	$R_L \geq 2k\Omega, V_O = \pm 10V$ $R_L \geq 1k\Omega, V_O = \pm 10V$ $R_L = 600\Omega, V_O = \pm 1V$ $V_S = \pm 4V$ (Note 4)		1000 800 250	1800 1500 700		700 1500 500		V/mV V/mV V/mV
$V_{OUT}$	Maximum Output Voltage Swing	$R_L \geq 2k\Omega$ $R_L \geq 600\Omega$		± 12.0 ± 10.0	± 13.8 ± 11.5		± 11.5 ± 10.0	± 13.5 ± 11.5	V V
SR	Slew Rate	$R_L \geq 2k\Omega$ (Note 4) $A_{VOL} \geq 5$ (Note 4)		1.7 11	2.8 17		1.7 11	2.8 17	V/ $\mu s$ V/ $\mu s$
GBW	Gain-Bandwidth Product	$f_o = 100kHz$ (Note 4) $f_o = 10kHz$ (Note 4) $f_o = 1MHz$ ( $A_{VOL} \geq 5$ )		5.0 45	8.0 63 40		5.0 45	8.0 63 40	MHz MHz MHz
$Z_O$	Open Loop Output Resistance	$V_O = 0, I_O = 0$		70			70		$\Omega$
$P_d$	Power Dissipation			90	140		100	170	mW

**ELECTRICAL CHARACTERISTICS**  $V_S = \pm 15V$ ,  $-55^\circ C \leq T_A \leq 125^\circ C$ , unless otherwise noted.

SYMBOL	PARAMETER	CONDITIONS		OP-27A/OP-37A			OP-27C/OP-37C			UNITS
				MIN	TYP	MAX	MIN	TYP	MAX	
$V_{OS}$	Input Offset Voltage	(Note 1)	•		30	60		70	300	$\mu V$
$\frac{\Delta V_{OS}}{\Delta Temp}$	Average Input Offset Drift	(Note 7)	•		0.2	0.6		0.4	1.8	$\mu V/^\circ C$
$I_{OS}$	Input Offset Current		•		15	50		30	135	nA
$I_B$	Input Bias Current		•		$\pm 20$	$\pm 60$		$\pm 35$	$\pm 150$	nA
	Input Voltage Range		•	$\pm 10.3$	$\pm 11.5$		$\pm 10.2$	$\pm 11.5$		V
CMRR	Common Mode Rejection Ratio	$V_{CM} = \pm 10V$	•	108	122		94	116		dB
PSRR	Power Supply Rejection Ratio	$V_S = \pm 4.5V$ to $\pm 18V$	•	96	116		86	110		dB
$A_{VOL}$	Large Signal Voltage Gain	$R_L \geq 2k\Omega$ , $V_O = \pm 10V$	•	600	1200		300	800		V/mV
$V_{OUT}$	Maximum Output Voltage Swing	$R_L \geq 2k\Omega$	•	$\pm 11.5$	$\pm 13.5$		$\pm 10.5$	$\pm 13.0$		V

**ELECTRICAL CHARACTERISTICS**  $V_S = \pm 15V$ ,  $-25^\circ C \leq T_A \leq 85^\circ C$ , unless otherwise noted.

SYMBOL	PARAMETER	CONDITIONS		OP-27E/OP-37E			OP-27G/OP-37G			UNITS
				MIN	TYP	MAX	MIN	TYP	MAX	
$V_{OS}$	Input Offset Voltage	(Note 1)	•		20	50		55	220	$\mu V$
$\frac{\Delta V_{OS}}{\Delta Temp}$	Average Input Offset Drift	(Note 7)	•		0.2	0.6		0.4	1.8	$\mu V/^\circ C$
$I_{OS}$	Input Offset Current		•		10	50		20	135	nA
$I_B$	Input Bias Current		•		$\pm 14$	$\pm 60$		$\pm 25$	$\pm 150$	nA
	Input Voltage Range		•	$\pm 10.5$	$\pm 11.8$		$\pm 10.5$	$\pm 11.8$		V
CMRR	Common Mode Rejection Ratio	$V_{CM} = \pm 10V$	•	110	124		96	118		dB
PSRR	Power Supply Rejection Ratio	$V_S = \pm 4.5V$ to $\pm 18V$	•	97	118		90	114		dB
$A_{VOL}$	Large Signal Voltage Gain	$R_L \geq 2k\Omega$ , $V_O = \pm 10V$	•	750	1500		450	1000		V/mV
$V_{OUT}$	Maximum Output Voltage Swing	$R_L \geq 2k\Omega$	•	$\pm 11.7$	$\pm 13.6$		$\pm 11.0$	$\pm 13.3$		V

The • denotes the specifications which apply over full operating temperature range.

**Note 1:** Input Offset Voltage measurements are performed by automatic test equipment approximately 0.5 seconds after application of power. A and E grades are guaranteed fully warmed up.

**Note 2:** Long Term Input Offset Voltage Stability refers to the average trend line of Offset Voltage vs Time over extended periods after the first 30 days of operation. Excluding the initial hour of operation, changes in  $V_{OS}$  during the first 30 days are typically  $2.5\mu V$ —refer to typical performance curve.

**Note 3:** Sample tested. Contact factory for 100% testing of 10Hz voltage noise.

**Note 4:** Parameter is guaranteed by design and is not tested.

**Note 5:** See test circuit and frequency response curve for 0.1Hz to 10Hz tester in Applications Information section.

**Note 6:** See test circuit for current noise measurement in Applications Information section.

**Note 7:** The Average Input Offset Drift performance is within the specifications unnullled or when nullled with a pot having a range of  $8k\Omega$  to  $20k\Omega$ .

**Note 8:** The OP-27/37's inputs are protected by back-to-back diodes. Current limiting resistors are not used in order to achieve low noise. If differential input voltage exceeds  $\pm 0.7V$ , the input current should be limited to 25mA.

# TYPICAL PERFORMANCE CHARACTERISTICS

Voltage Noise vs Frequency

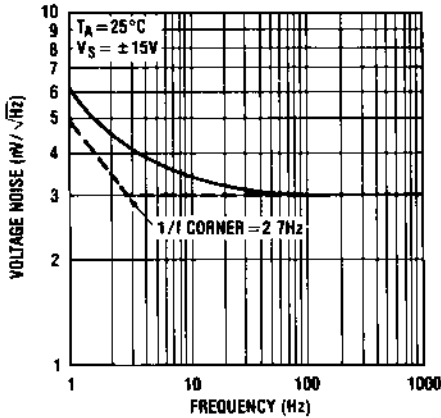

Input Wideband Voltage Noise vs Bandwidth (0.1Hz to Frequency Indicated)

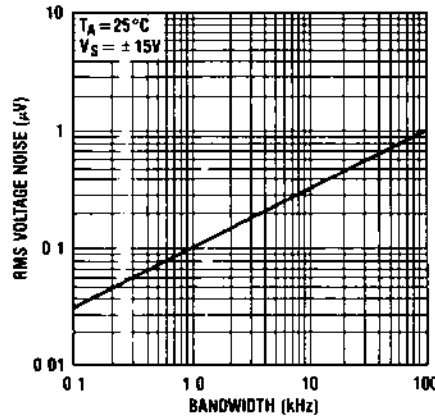

Total Noise vs Source Resistance

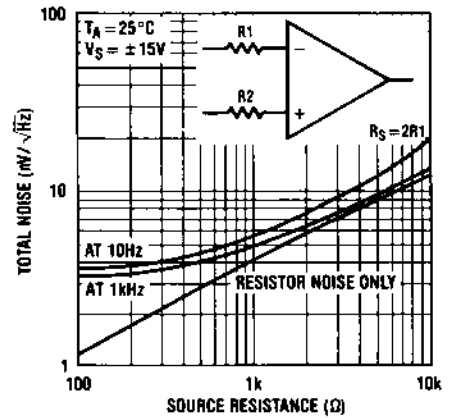

Voltage Noise vs Temperature

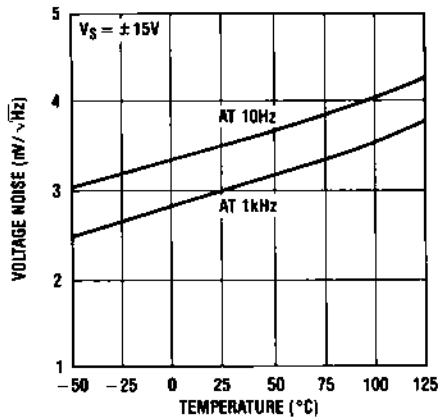

Voltage Noise vs Supply Voltage

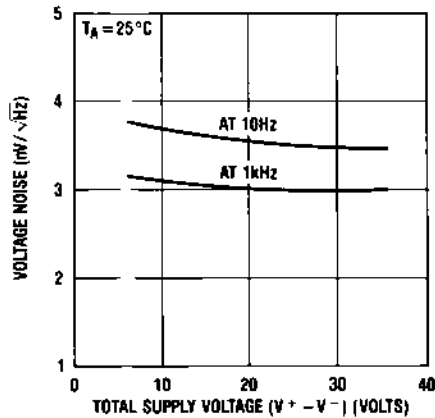

Current Noise vs Frequency

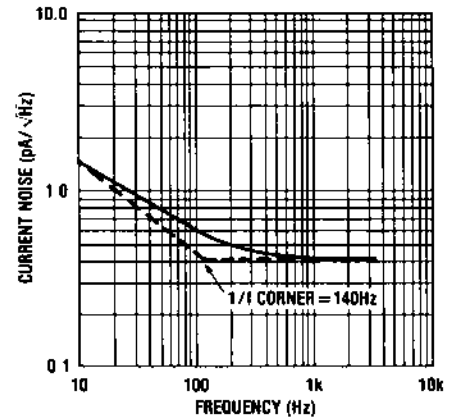

Voltage Gain vs Frequency

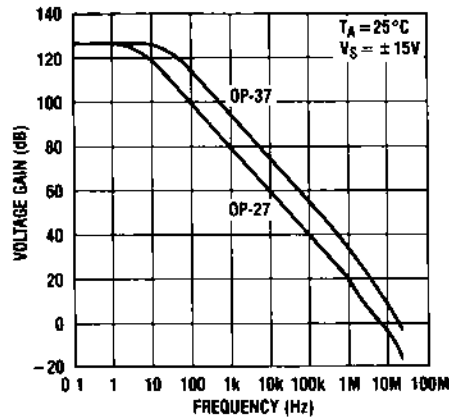

Open Loop Voltage Gain vs Supply Voltage

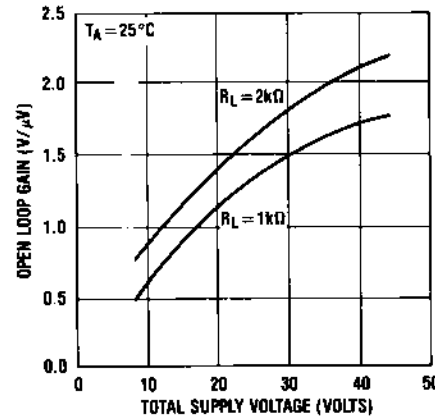

Open Loop Voltage Gain vs Load Resistance

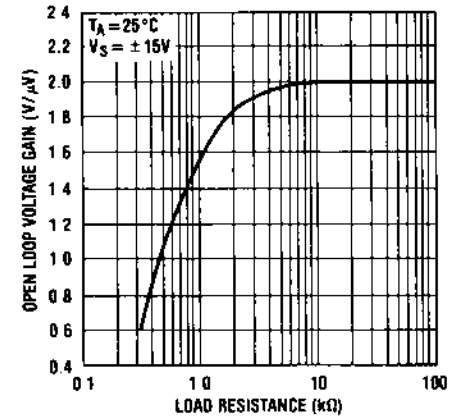

# TYPICAL PERFORMANCE CHARACTERISTICS

Offset Voltage Drift of Representative Units

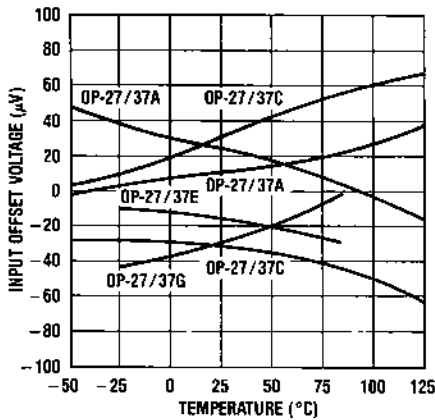

Long Term Drift of Representative Units

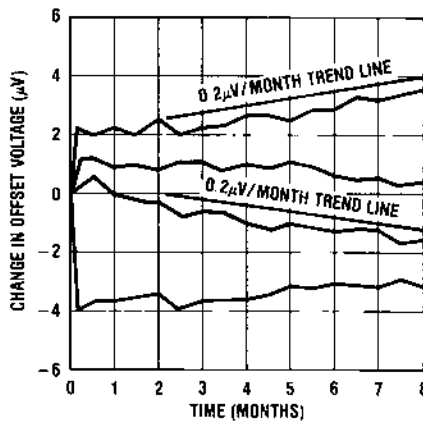

Warm-Up Drift

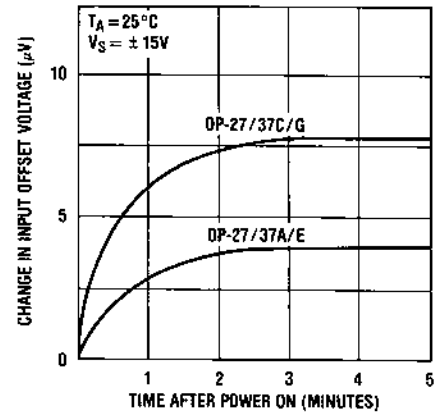

Offset Voltage Change Due to Thermal Shock

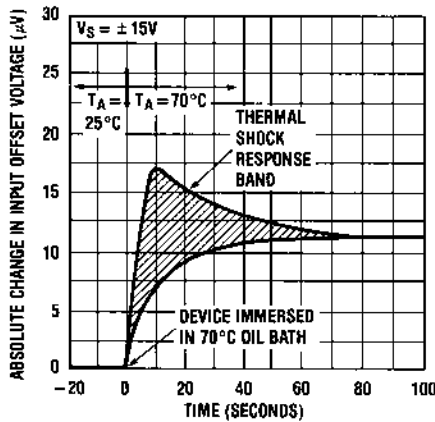

Input Bias Current vs Temperature

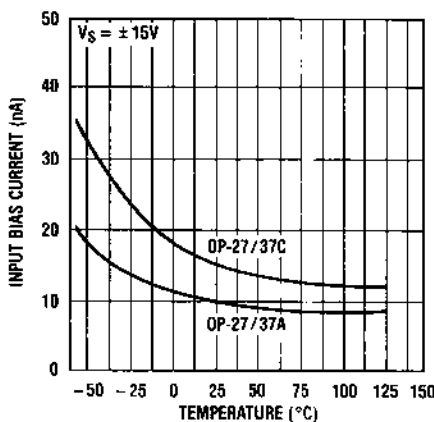

Input Offset Current vs Temperature

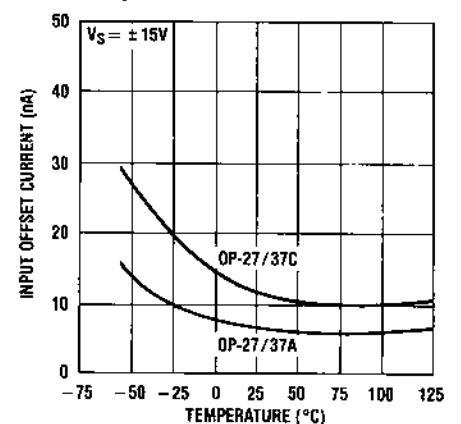

Supply Current vs Supply Voltage

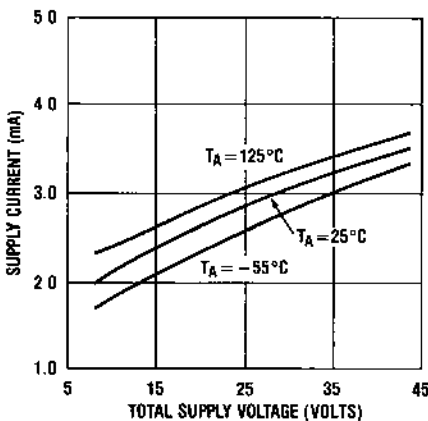

Short Circuit Current vs Time

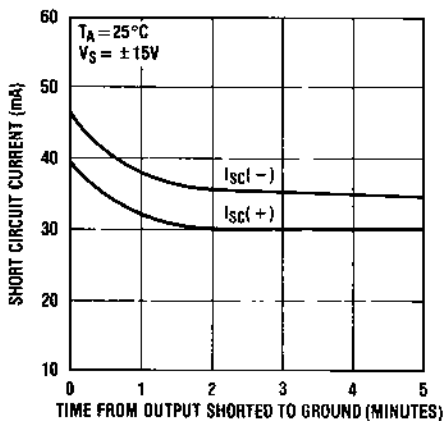

Maximum Output Swing vs Resistive Load

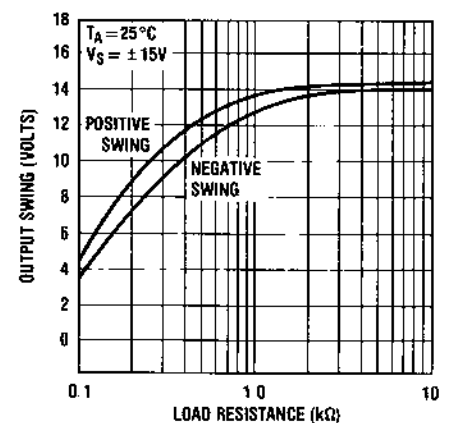

# TYPICAL PERFORMANCE CHARACTERISTICS

**Common Mode Rejection vs Frequency**

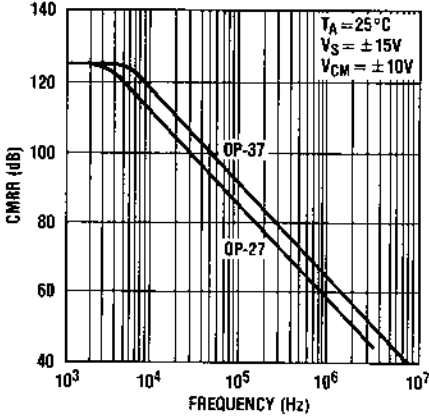

**Common Mode Input Range vs Supply Voltage**

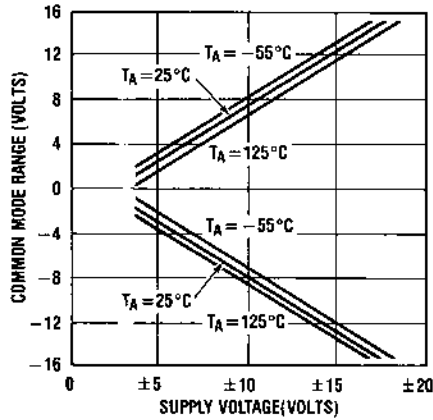

**PSRR vs Frequency**

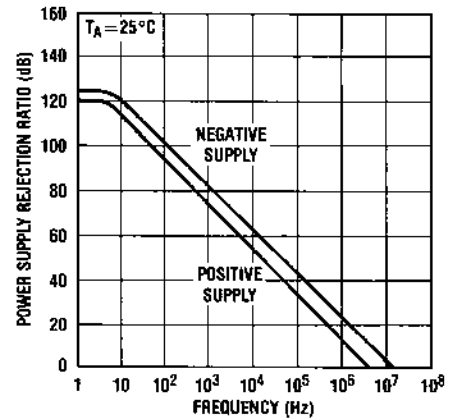

**OP-27 Small Signal Transient Response**

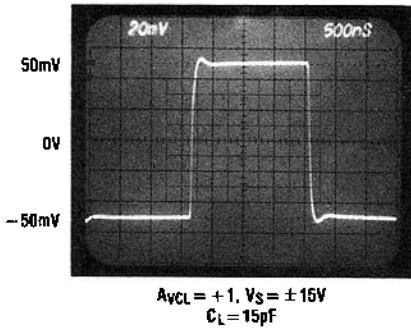

**OP-27 Large Signal Transient Response**

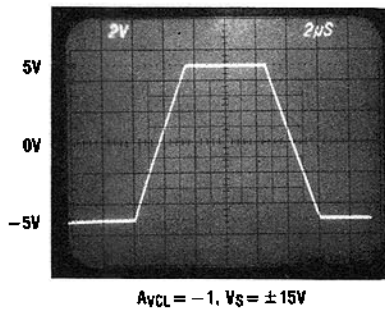

**OP-27 Maximum Undistorted Output vs Frequency**

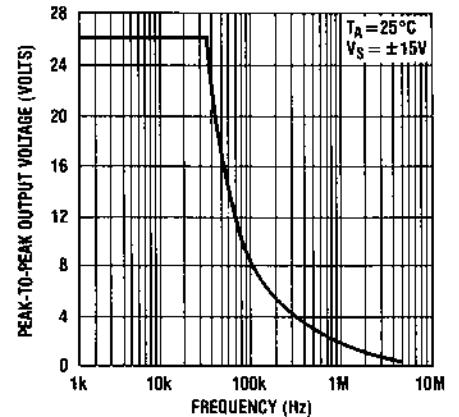

**OP-27 Slew Rate, Gain Bandwidth Product, Phase Margin vs Temperature**

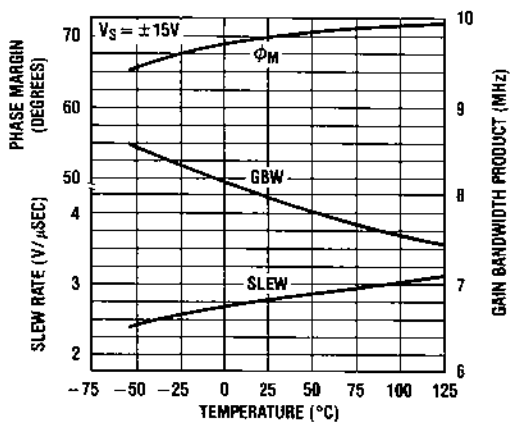

**OP-27 Gain, Phase Shift vs Frequency**

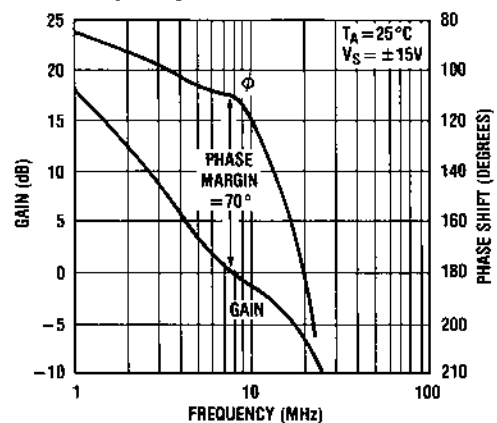

# TYPICAL PERFORMANCE CHARACTERISTICS

**OP-37 Small Signal Transient Response**

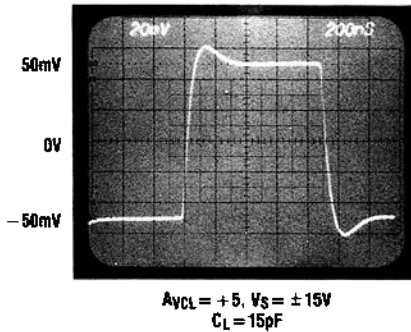

**OP-37 Large Signal Response**

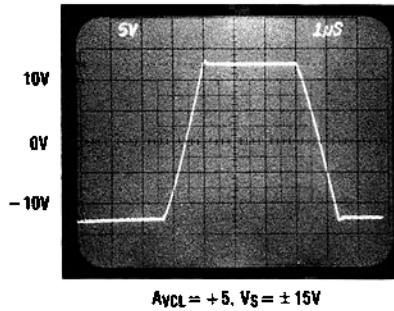

**OP-37 Maximum Undistorted Output vs Frequency**

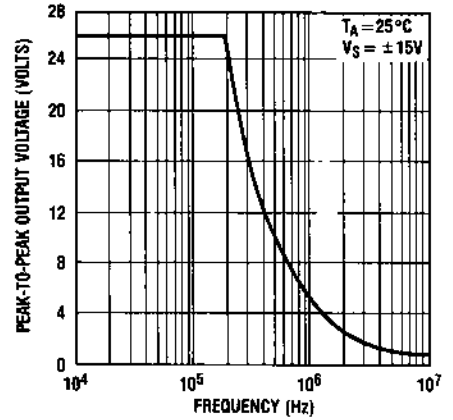

**OP-37 Slew Rate, Gain Bandwidth Product, Phase Margin vs Temperature**

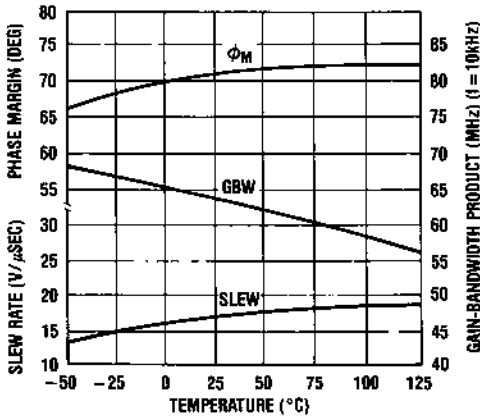

**OP-37 Gain, Phase Shift vs Frequency**

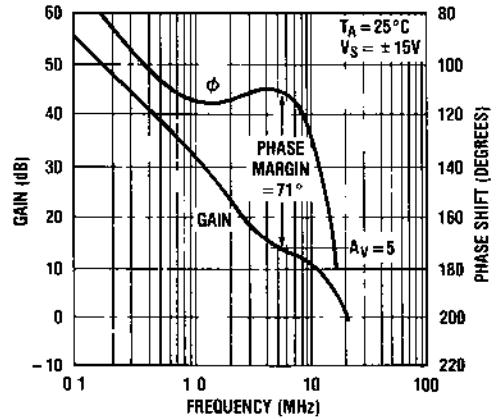

**OP-37 Slew Rate vs Load**

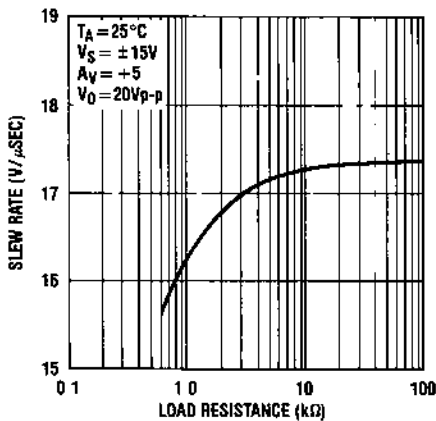

**OP-37 Slew Rate vs Supply Voltage**

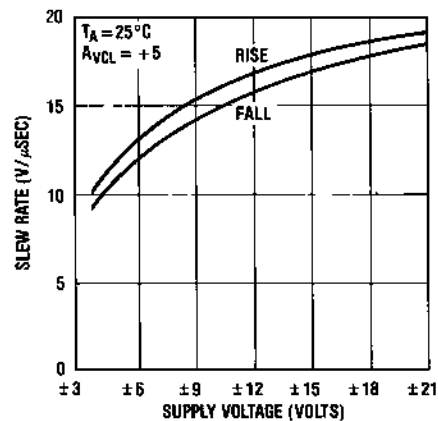

## APPLICATIONS INFORMATION

### General

The OP-27/37 series devices may be inserted directly into OP-07, OP-05, 725, and 5534 sockets with or without removal of external compensation or nulling components. In addition, the OP-27/37 may be fitted to 741 sockets with the removal or modification of external nulling components.

### Noise Testing

The 0.1Hz to 10Hz peak-to-peak noise of the OP-27/OP-37 is measured in the test circuit shown. The frequency response of this noise tester indicates that the 0.1Hz corner is defined by only one zero. The test time to measure 0.1Hz to 10Hz noise should not exceed 10 seconds, as this time limit acts as an additional zero to eliminate noise contributions from the frequency band below 0.1Hz.

Measuring the typical 80nV peak-to-peak noise performance of the OP-27/37 requires special test precautions:

- (a) The device should be warmed up for at least five minutes. As the op amp warms up, its offset voltage changes typically  $4\mu\text{V}$  due to its chip temperature increasing  $10^\circ\text{C}$  to  $20^\circ\text{C}$  from the moment the power supplies are turned on. In the 10 second measurement interval these temperature-induced effects can easily exceed tens of nanovolts.

- (b) For similar reasons, the device must be well shielded from air currents to eliminate the possibility of thermoelectric effects in excess of a few nanovolts, which would invalidate the measurements.
- (c) Sudden motion in the vicinity of the device can also "feedthrough" to increase the observed noise.

A noise-voltage density test is recommended when measuring noise on a large number of units. A 10Hz noise-voltage density measurement will correlate well with a 0.1Hz to 10Hz peak-to-peak noise reading since both results are determined by the white noise and the location of the  $1/f$  corner frequency.

Current noise is measured and calculated by the following formula:

$$i_n = \frac{[e^2_{no} - (130\text{nV})^2]^{1/2}}{1\text{M}\Omega \times 100}$$

0.1Hz to 10Hz Noise Test Circuit

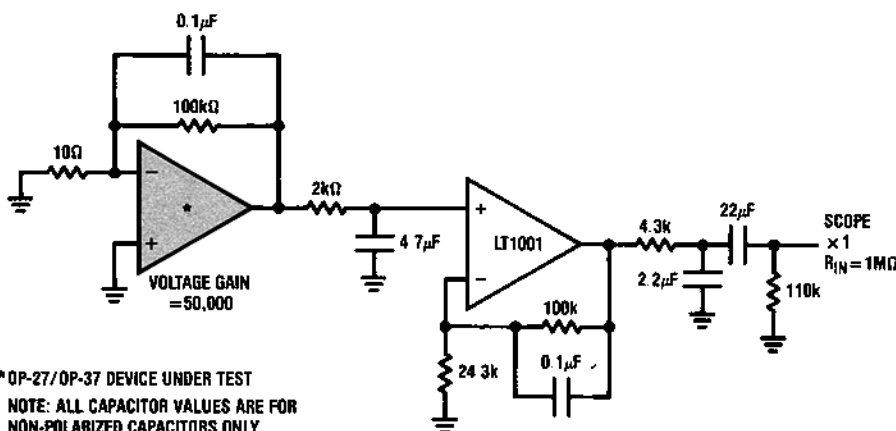

0.1Hz to 10Hz p-p Noise Tester Frequency Response

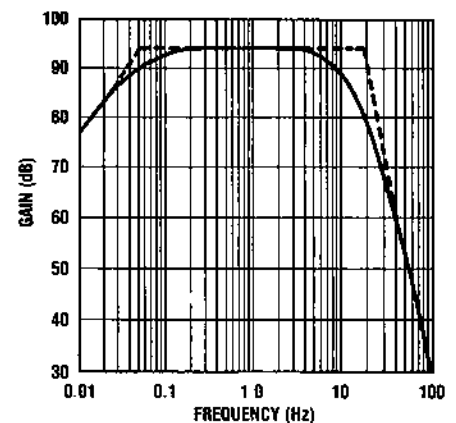



## APPLICATIONS INFORMATION

### Offset Voltage Adjustment

The input offset voltage of the OP-27/37, and its drift with temperature, are permanently trimmed at wafer testing to a low level. However, if further adjustment of  $V_{OS}$  is necessary, the use of a 10k nulling potentiometer will not degrade drift with temperature. Trimming to a value other than zero creates a drift of  $(V_{OS}/300) \mu V/^\circ C$ , e.g., if  $V_{OS}$  is adjusted to  $300 \mu V$ , the change in drift will be  $1 \mu V/^\circ C$ .

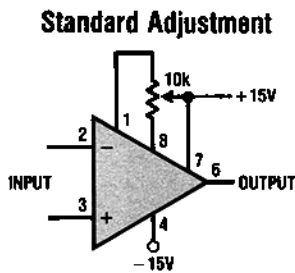

The adjustment range with a 10k pot is approximately  $\pm 2.5mV$ . If less adjustment range is needed, the sensitivity and resolution of the nulling can be improved by using a smaller pot in conjunction with fixed resistors. The example has an approximate null range of  $\pm 200 \mu V$ .

### Improved Sensitivity Adjustment

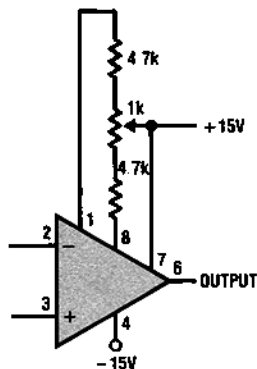

### Offset Voltage and Drift

Thermocouple effects, caused by temperature gradients across dissimilar metals at the contacts to the input terminals, can exceed the inherent drift of the amplifier unless proper care is exercised. Air currents should be minimized, package leads should be short, the two input leads should be close together and maintained at the same temperature.

The circuit shown to measure offset voltage is also used as the burn-in configuration for the OP-27/37, with the supply voltages increased to  $\pm 20V$ ,  $R_1 = R_3 = 10k$ ,  $R_2 = 200\Omega$ ,  $A_V = 100$ .

### Test Circuit for Offset Voltage and Offset Voltage Drift with Temperature

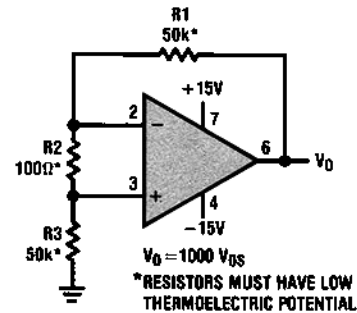

### Unity Gain Buffer Applications (OP-27 Only)

When  $R_f \leq 100\Omega$  and the input is driven with a fast, large signal pulse ( $> 1V$ ), the output waveform will look as shown in the pulsed operation diagram.

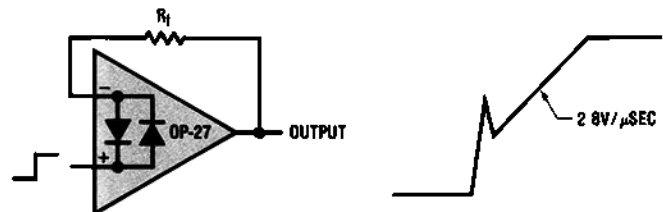

During the fast feedthrough-like portion of the output, the input protection diodes effectively short the output to the input and a current, limited only by the output short circuit protection, will be drawn by the signal generator. With  $R_f \geq 500\Omega$ , the output is capable of handling the current requirements ( $I_L \leq 20mA$  at  $10V$ ) and the amplifier stays in its active mode and a smooth transition will occur.

As with all operational amplifiers when  $R_f > 2k\Omega$ , a pole will be created with  $R_f$  and the amplifier's input capacitance, creating additional phase shift and reducing the phase margin. A small capacitor ( $20pF$  to  $50pF$ ) in parallel with  $R_f$  will eliminate this problem.

**SCHEMATIC DIAGRAM**

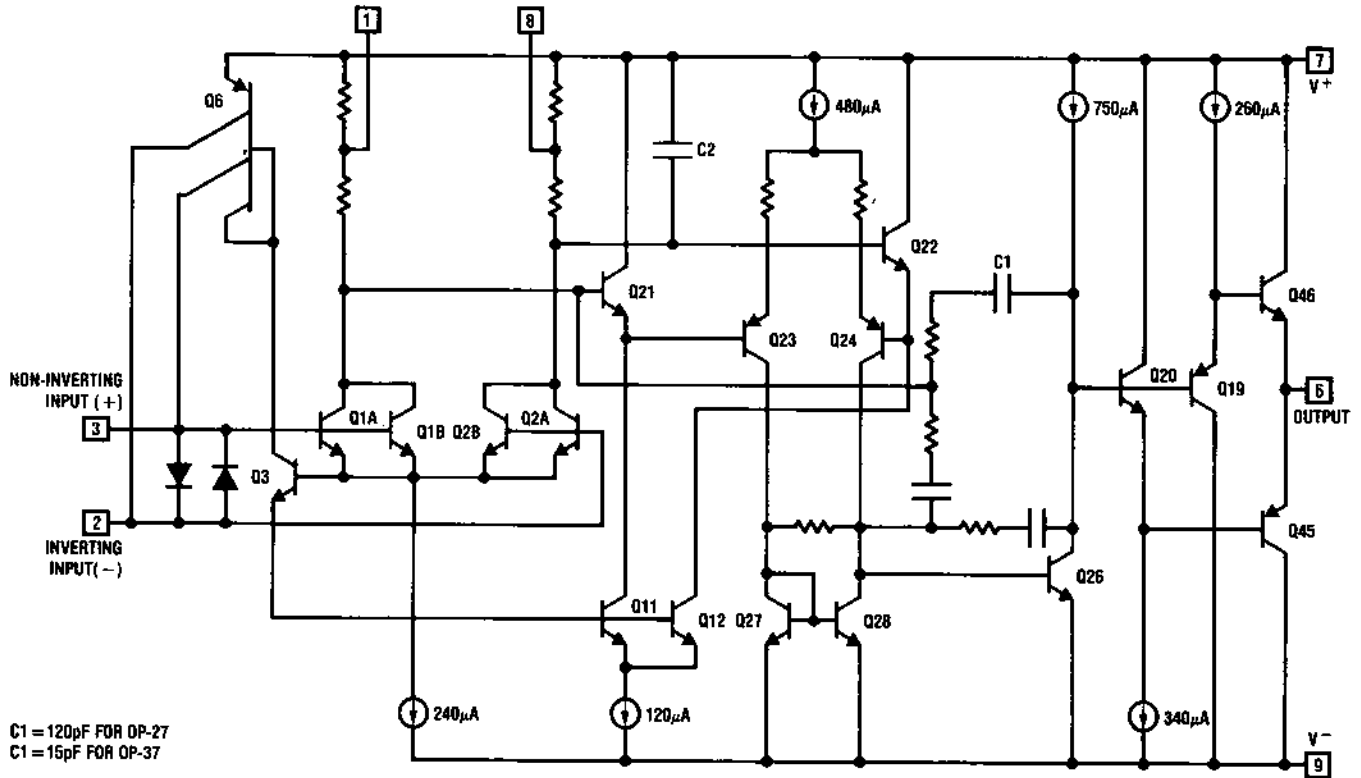

# PACKAGE DESCRIPTION

## H Package Metal Can

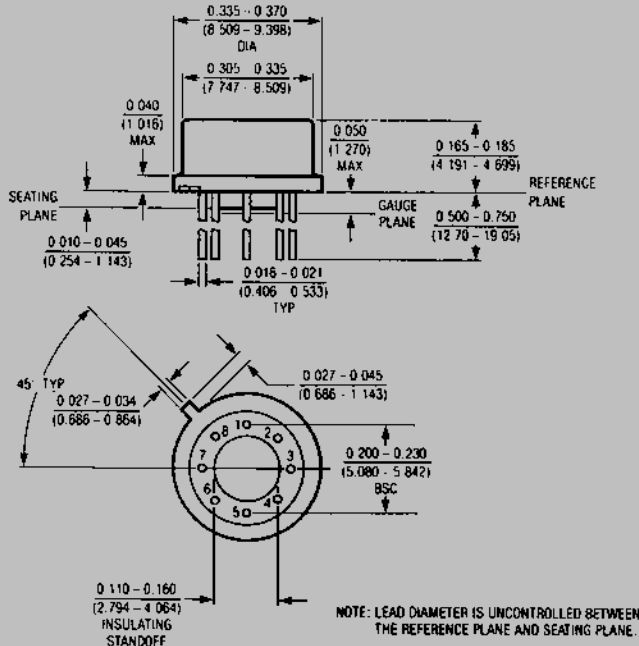

NOTE: DIMENSIONS IN INCHES (MILLIMETERS)

$T_{jmax}$	$\theta_{j\alpha}$	$\theta_{jc}$
150°C	150°C/W	45°C/W

## J8 Package 8 Lead Hermetic DIP

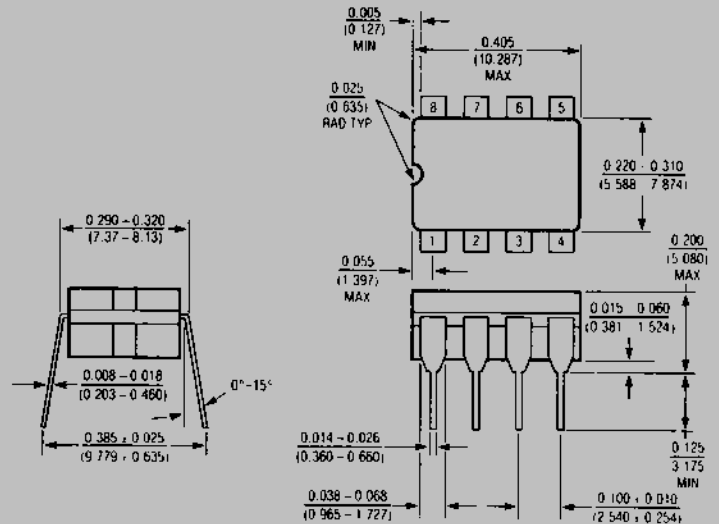

NOTE: DIMENSIONS IN INCHES (MILLIMETERS) UNLESS OTHERWISE NOTED \*LEADS WITHIN 0.007 OF TRUE POSITION (TP) AT GAUGE PLANE

$T_{jmax}$	$\theta_{j\alpha}$
150°C	100°C/W

OBSOLETE PACKAGE

## N8 Package 8 Lead Plastic

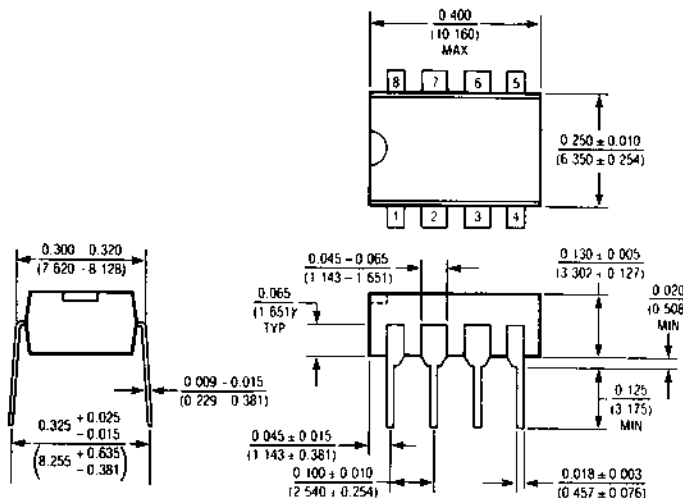

NOTE: DIMENSIONS IN INCHES UNLESS OTHERWISE NOTED \*LEADS WITHIN 0.007 OF TRUE POSITION (TP) AT GAUGE PLANE

$T_{jmax}$	$\theta_{j\alpha}$
100°C	130°C/W

# NOTES

---