

LTM4678 Dual 25A or Single 50A μ Module Regulator with Digital Power System Management 4x LTM4678; 200A

DESCRIPTION

Demonstration circuit 2638A-C is a high efficiency, high density, μ Module regulator with 4.5V to 16V input range. The output voltage is adjustable from 0.5V to 3.3V, and it can supply 200A maximum load current. The demo board has four LTM4678 μ Module regulators, and the LTM4678 is a dual 25A or single 50A step-down regulator with PMBus power system management. Please see LTM4678 data sheet for more detailed information.

DC2638A-C powers up to default settings and produce power based on configuration resistors without the need for any serial bus communication. This allows easy evaluation of the DC/DC converter. To fully explore the extensive power system management features of the part, download

the GUI software LTpowerPlay® onto your PC and use ADI's I²C/SMBus/PMBus dongle DC1613A to connect to the board. LTpowerPlay allows the user to reconfigure the part on-the-fly and store the configuration in EEPROM, view telemetry of voltage, current, temperature and fault status.

GUI Download

The software can be downloaded from:

[LTpowerPlay](#)

For more details and instructions of LTpowerPlay, please refer to LTpowerPlay GUI for LTM4678 Quick Start Guide.

Design files for this circuit board are available.

All registered trademarks and trademarks are the property of their respective owners.

PERFORMANCE SUMMARY

Specifications are at T_A = 25°C

PARAMETER	CONDITIONS	VALUE
Input Voltage Range		4.5V to 16V
Output Voltage, V _{OUT}	V _{IN} = 4.5V–16V, I _{OUT} = 0A to 200A	0.5V to 3.3V, Default: 1.0V
Maximum Output Current, I _{OUT}	V _{IN} = 4.5V–16V, V _{OUT} = 0.5V to 3.3V	200A
Typical Efficiency	V _{IN} = 12V, V _{OUT} = 1.0V, I _{OUT} = 200A	86% (See Figure 5)
Default Switching Frequency		350kHz

BOARD PHOTO

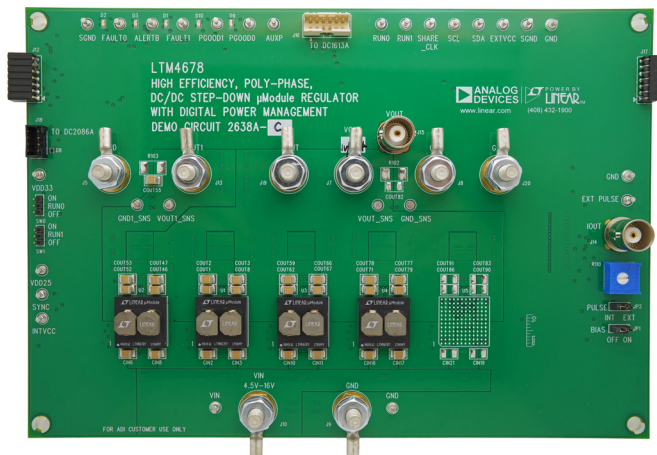

Figure 1. 4x LTM4678; 200A DC2638A-C Demo Circuit

QUICK START PROCEDURE

Table 1. LTM4678 Demo Boards for up to 250A Point-of-Load Regulation

MAXIMUM OUTPUT CURRENT	NUMBER OF OUTPUTS	NUMBER OF LTM4678 μ Module REGULATORS ON THE BOARD	DEMO BOARD NUMBER
25A	2	1	DC2552A
50A	1	1	DC2570A
100A	1	2	DC2638A-A
150A	1	3	DC2638A-B
200A	1	4	DC2638A-C
250A	1	5	DC2638A-D

Demonstration circuit 2638A-C is easy to set up to evaluate the performance of the LTM4678EY. Refer to Figure 2 for the proper measurement equipment setup and follow the procedure below.

1. With power off, connect the input power supply to V_{IN} (4.5V–16V) and GND (input return).
2. Connect the 1.0V output load between V_{OUT} and GND (Initial load: no load).
3. Connect the DVMs to the input and output. Set default jumper position: SW0: ON; SW1: ON.
4. Turn on the input power supply and check for the proper output voltage. V_{OUT} should be $1.0V \pm 0.5\%$.
5. Once the proper output voltages are established, adjust the load within the operating range and observe the output voltage regulation, ripple voltage and other parameters.

6. Connect the dongle and control the output voltage from the GUI. See “LTpowerPlay GUI for the LTM4678 Quick Start Guide” for details.

Note: When measuring the output or input voltage ripple, do not use the long ground lead on the oscilloscope probe. See Figure 3 for the proper scope probe technique. Short, stiff leads need to be soldered to the (+) and (–) terminals of an output capacitor. The probe’s ground ring needs to touch the (–) lead and the probe tip needs to touch the (+) lead.

Connecting a PC to DC2638A-C

You can use a PC to reconfigure the power management features of the LTM4678 such as: nominal V_{OUT} , margin set points, OV/UV limits, temperature fault limits, sequencing parameters, the fault log, fault responses, GPIOs and other functionalities. The DC1613A dongle may be plugged when V_{IN} is present.

QUICK START PROCEDURE

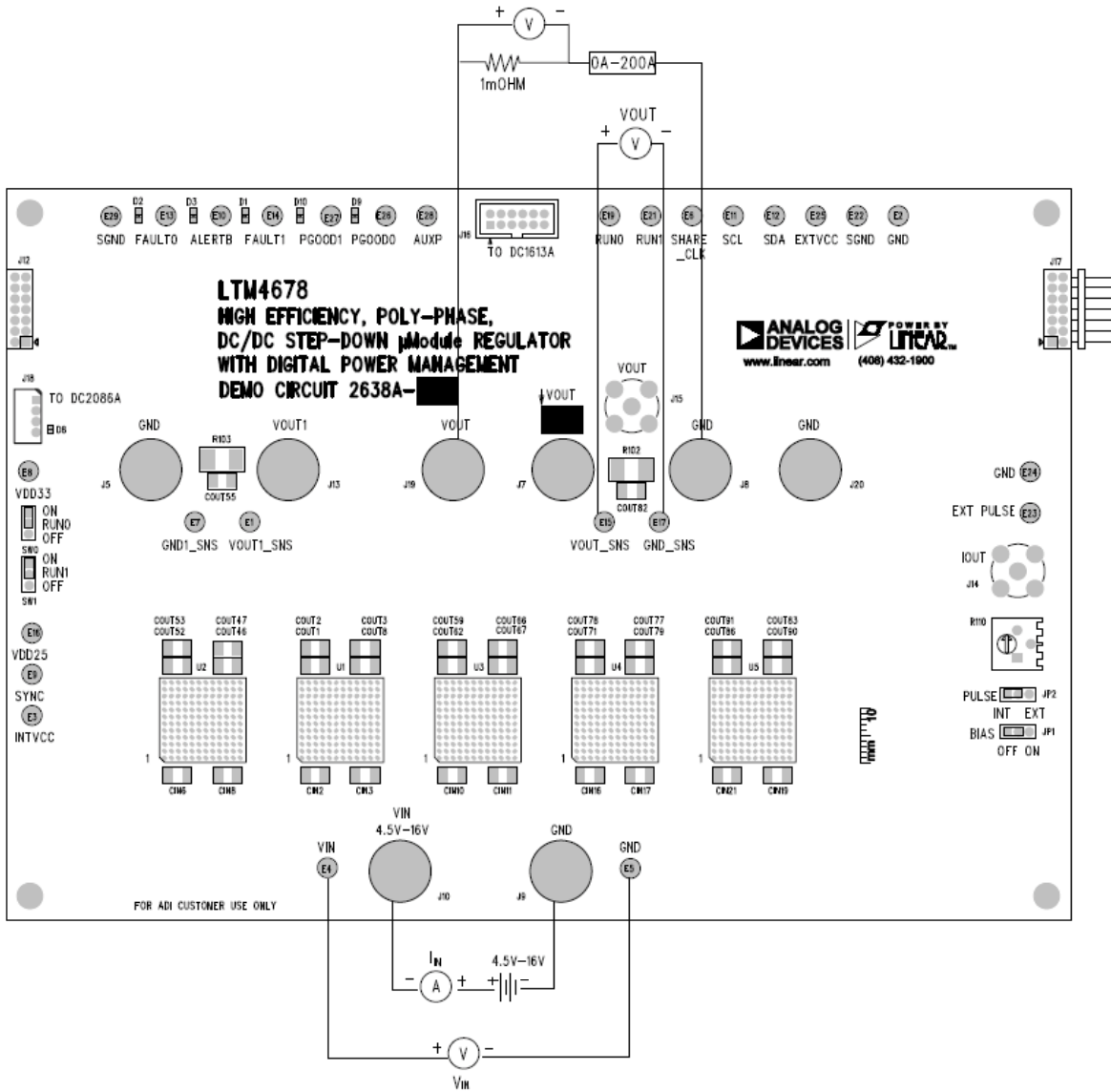

Figure 2. Proper Measurement Equipment Setup

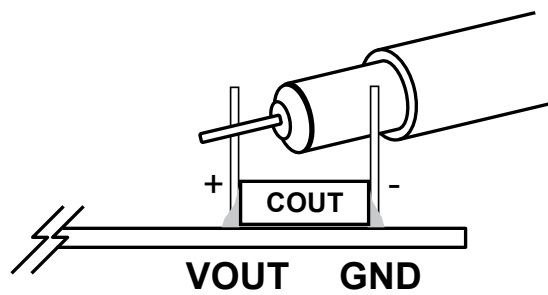

Figure 3. Measuring Output Voltage Ripple

QUICK START PROCEDURE

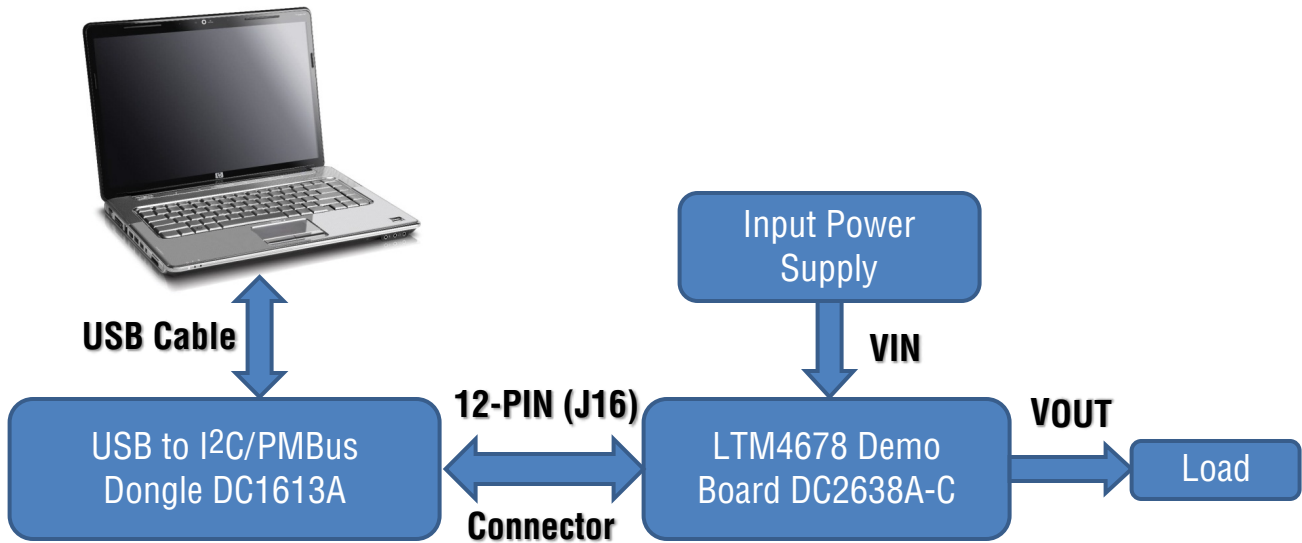

Figure 4. Demo Setup with PC

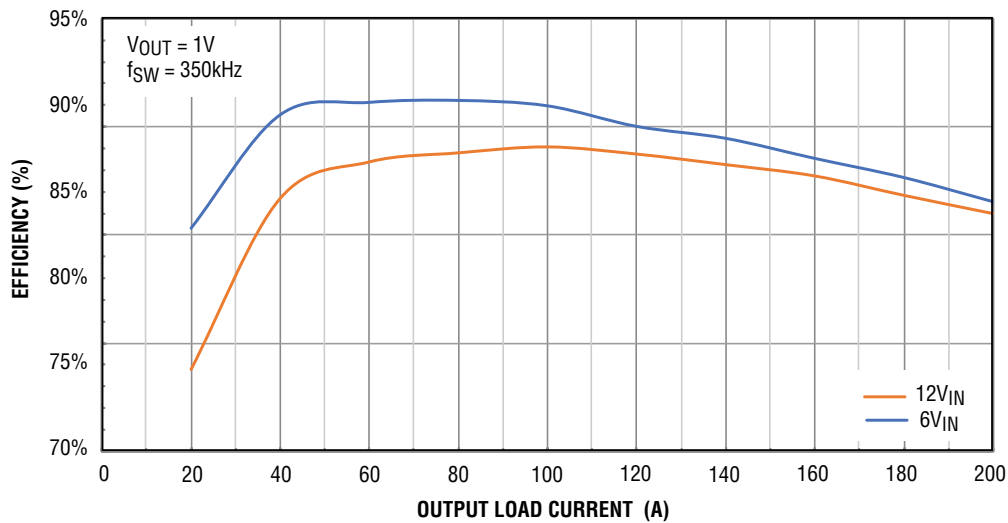

Figure 5. Efficiency vs Load Current

QUICK START PROCEDURE

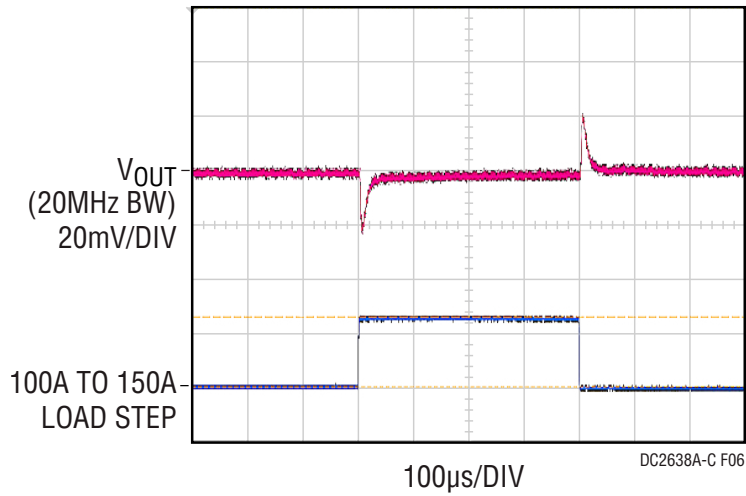

Figure 6. Output Voltage V_{OUT} vs Load Current @ V_{IN} = 12V, V_{OUT} = 1V, f_{SW} = 350kHz

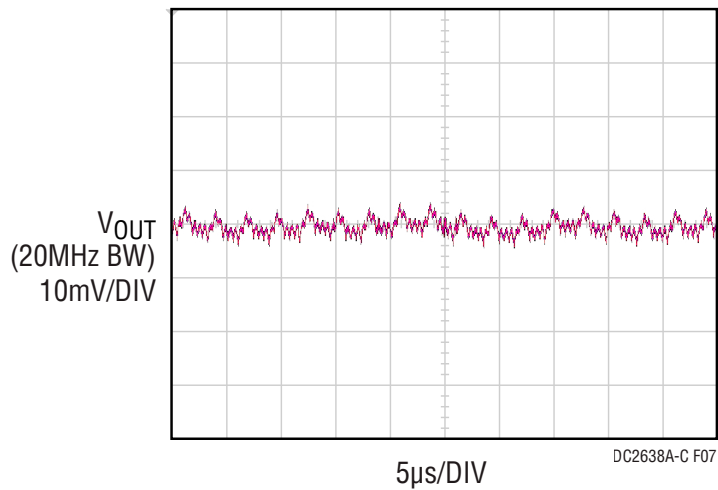

Figure 7. Output Voltage Ripple @ V_{IN} = 12V, V_{OUT} = 1V, I_{OUT} = 200A, f_{SW} = 350kHz

QUICK START PROCEDURE

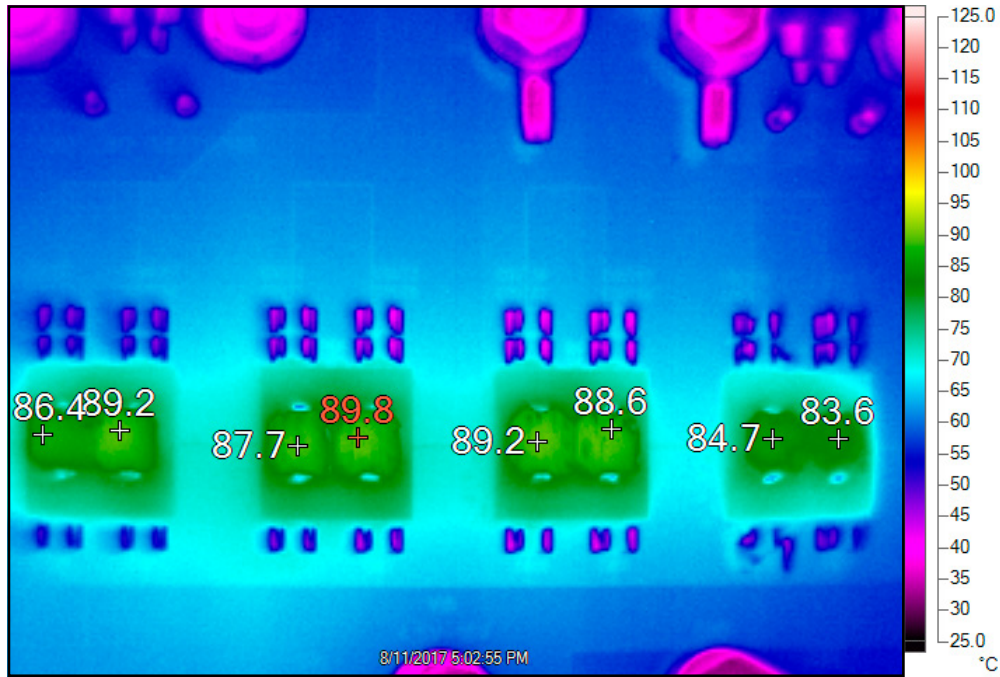

Figure 8. Thermal @ $V_{IN} = 12V$, $V_{OUT} = 1.0V$, $I_{OUT} = 130A$, $T_A = 25^\circ C$, No Airflow

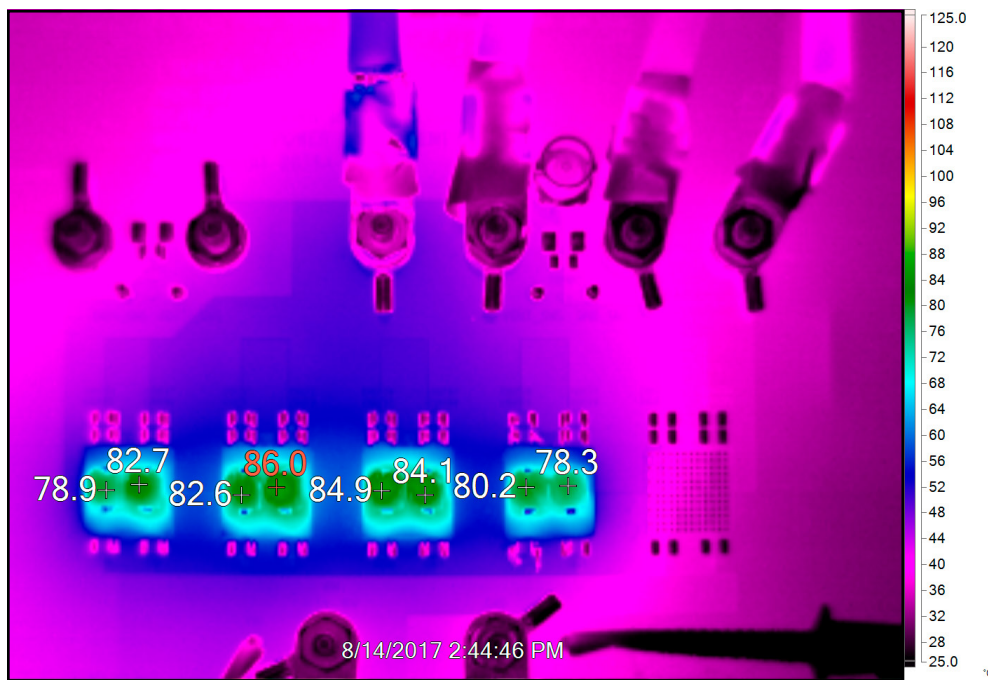

Figure 9. Thermal @ $V_{IN} = 12V$, $V_{OUT} = 1.0V$, $I_{OUT} = 180A$, $T_A = 25^\circ C$, 400LFM Airflow

LTPOWERPLAY SOFTWARE GUI

LTpowerPlay is a powerful Windows-based development environment that supports Analog Devices power system management ICs and μ Modules, including the LTM4675, LTM4676, LTM4677, LTM4678, LTC3880, LTC3882 and LTC3883. The software supports a variety of different tasks. You can use LTpowerPlay to evaluate Analog Devices ICs by connecting to a demo board system. LTpowerPlay can also be used in an offline mode (with no hardware present) in order to build a multichip configuration file that can be saved and reloaded at a later time. LTpowerPlay provides unprecedented diagnostic and debug features. It becomes a valuable diagnostic tool during board bringup to program or tweak the power management scheme in a system, or to diagnose power issues when bringing up rails. LTpowerPlay utilizes the

DC1613A USB-to-SMBus controller to communicate with one of many potential targets, including the LTM4675, LTM4676, LTM4677, LTM4678, LTC3880, LTC3882, LTC3883's demo system, or a customer board. The software also provides an automatic update feature to keep the software current with the latest set of device drivers and documentation. The LTpowerPlay software can be downloaded from:

[LTpowerPlay](#)

To access technical support documents for ADI Digital Power Products visit the LTpowerPlay Help menu. Online help also available through the LTpowerPlay.

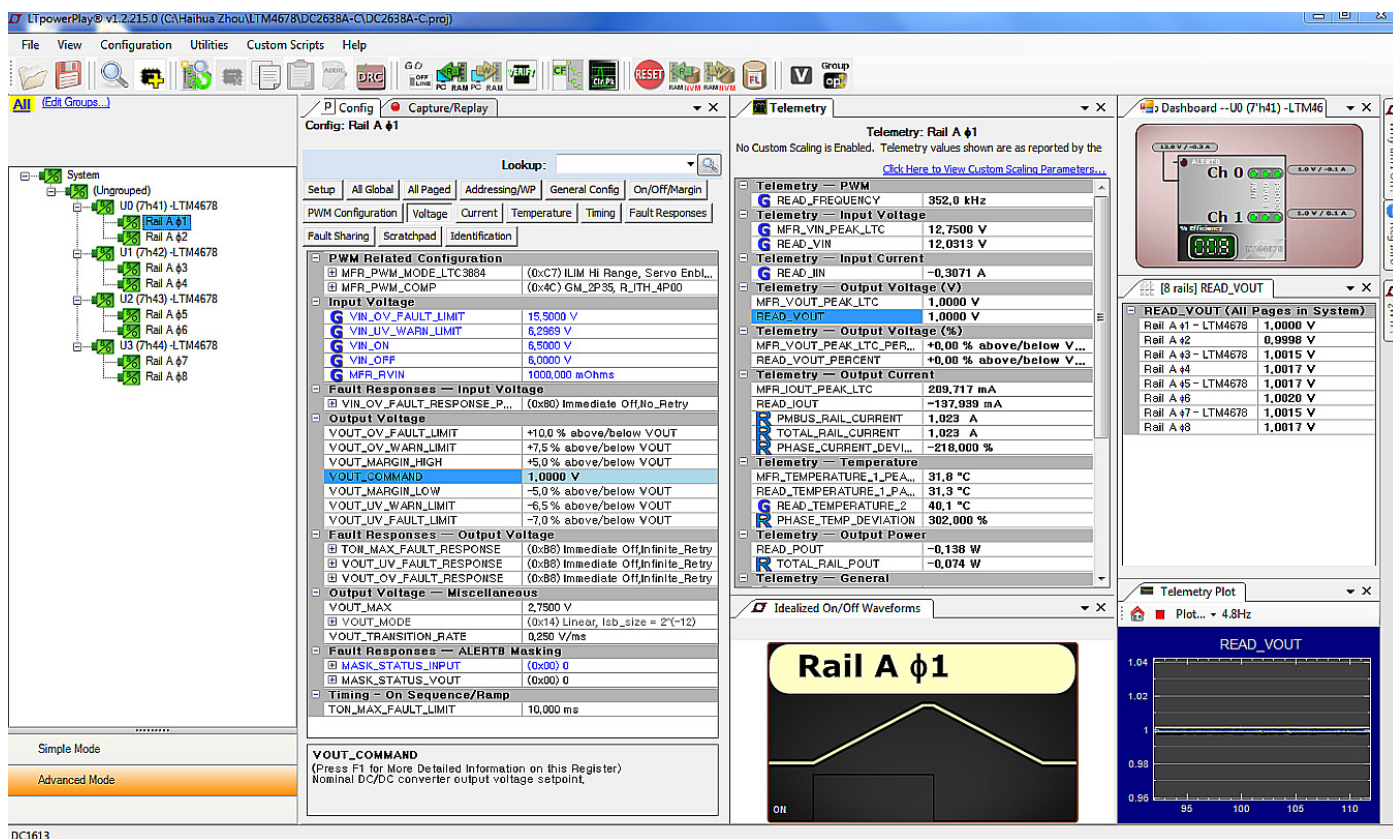

Figure 10. LTpowerPlay Main Interface

LTPOWERPLAY QUICK START PROCEDURE

The following procedure describes how to use LTpowerPlay to monitor and change the settings of LTM4678.

1. Download and install the LTpowerPlay GUI:

[LTpowerPlay](#)

2. Launch the LTpowerPlay GUI.

a. The GUI should automatically identify the DC2638A-C. The system tree on the left hand side should look like this:

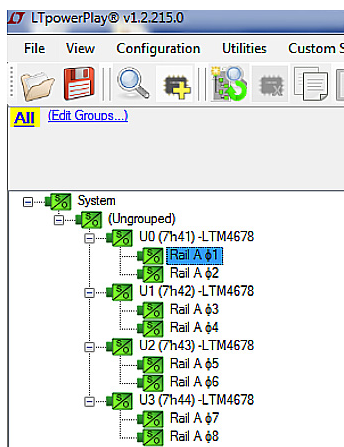

b. A green message box shows for a few seconds in the lower left hand corner, confirming that LTM4678 is communicating:

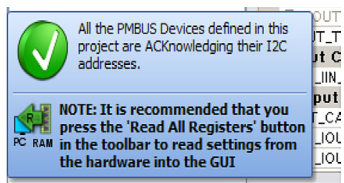

c. In the Toolbar, click the “R” (RAM to PC) icon to read the RAM from the LTM4678. This reads the configuration from the RAM of LTM4678 and loads it into the GUI.



d. If you want to change the output voltage to a different value, like 0.8V. In the Config tab, type in 0.8 in the VOUT_COMMAND box, like this:

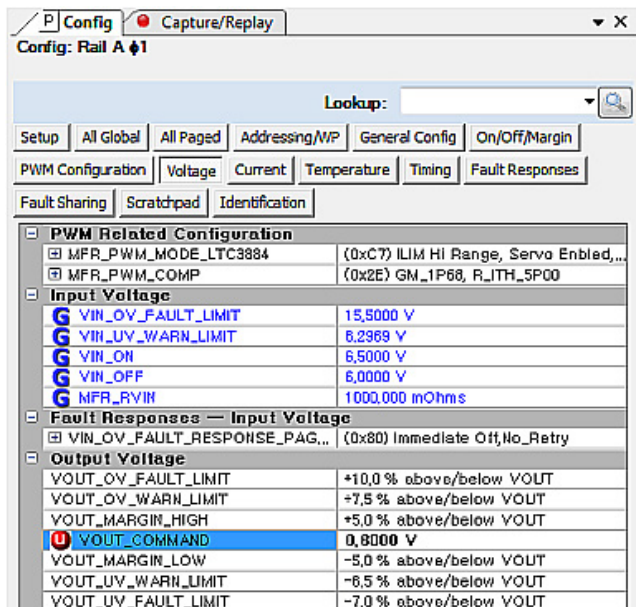

Then, click the “W” (PC to RAM) icon to write these register values to the LTM4678. After finishing this step, you will see the output voltage will change to 0.8V.



If the write is successful, you will see the following message:

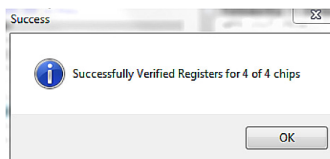

e. You can save the changes into the NVM. In the tool bar, click “RAM to NVM” button, as following



f. Save the demo board configuration to a (*.proj) file. Click the Save icon and save the file. Name it whatever you want.

DEMO MANUAL DC2638A-C

SCHEMATIC DIAGRAM

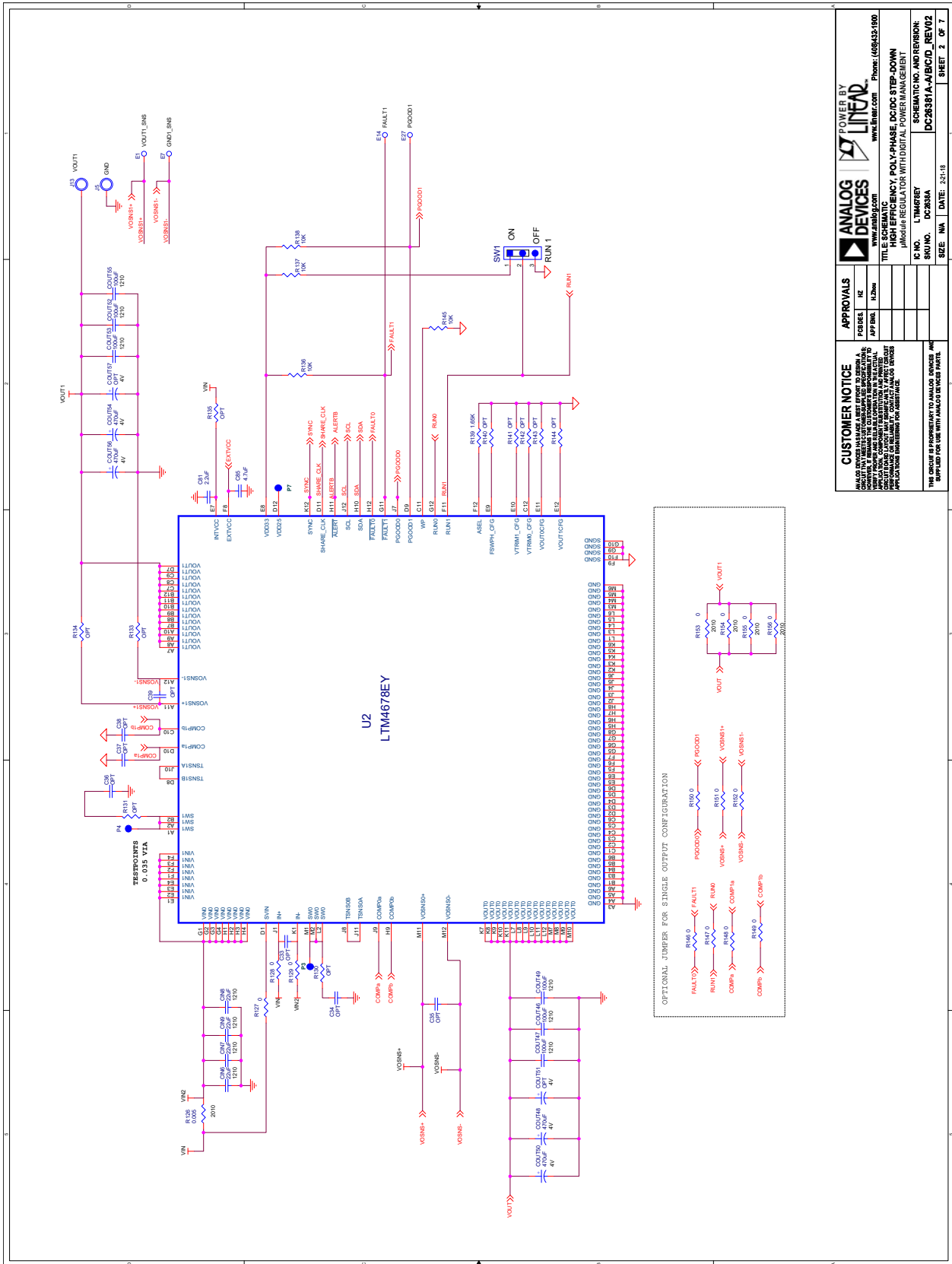

ANALOG DEVICES		POWER BY LINEAR	
www.analog.com		www.linear.com	
Phone: (800) 424-6300		Phone: (800) 424-6300	
TITLE SCHEMATIC			
APP NO. 11.200			
DESCRIPTION POLY-PHASE DC/DC STEP-DOWN			
ADJUSTABLE REGULATOR WITH DIGITAL POWER MANAGEMENT			
IC NO.	LTM4678EY	SCHEMATIC AND REVISION	
SKU NO.	DC2638A-C	DC2638A-A-B/C/D	REV02
SIZE	10A	DATE	2/21/18
			SHEET 2 OF 7

CUSTOMER NOTICE

ALL INFORMATION CONTAINED HEREIN IS UNCLASSIFIED EXCEPT WHERE SHOWN OTHERWISE. IT IS THE PROPERTY OF ANALOG DEVICES, INC. AND IS LOANED TO YOUR COMPANY. IT IS TO BE USED ONLY FOR THE SPECIFIC PURPOSE AND FOR THE PROJECT AND PERIOD OF TIME FOR WHICH IT WAS LOANED. IT IS NOT TO BE REPRODUCED OR TRANSMITTED IN ANY FORM OR BY ANY MEANS, ELECTRONIC OR MECHANICAL, INCLUDING PHOTOCOPYING, RECORDING, OR BY ANY INFORMATION STORAGE AND RETRIEVAL SYSTEM, WITHOUT THE WRITTEN PERMISSION OF ANALOG DEVICES, INC.

THIS DEVICE IS UNCLASSIFIED EXCEPT WHERE SHOWN OTHERWISE. IT IS THE PROPERTY OF ANALOG DEVICES, INC. AND IS LOANED TO YOUR COMPANY. IT IS TO BE USED ONLY FOR THE SPECIFIC PURPOSE AND FOR THE PROJECT AND PERIOD OF TIME FOR WHICH IT WAS LOANED. IT IS NOT TO BE REPRODUCED OR TRANSMITTED IN ANY FORM OR BY ANY MEANS, ELECTRONIC OR MECHANICAL, INCLUDING PHOTOCOPYING, RECORDING, OR BY ANY INFORMATION STORAGE AND RETRIEVAL SYSTEM, WITHOUT THE WRITTEN PERMISSION OF ANALOG DEVICES, INC.

SCHEMATIC DIAGRAM

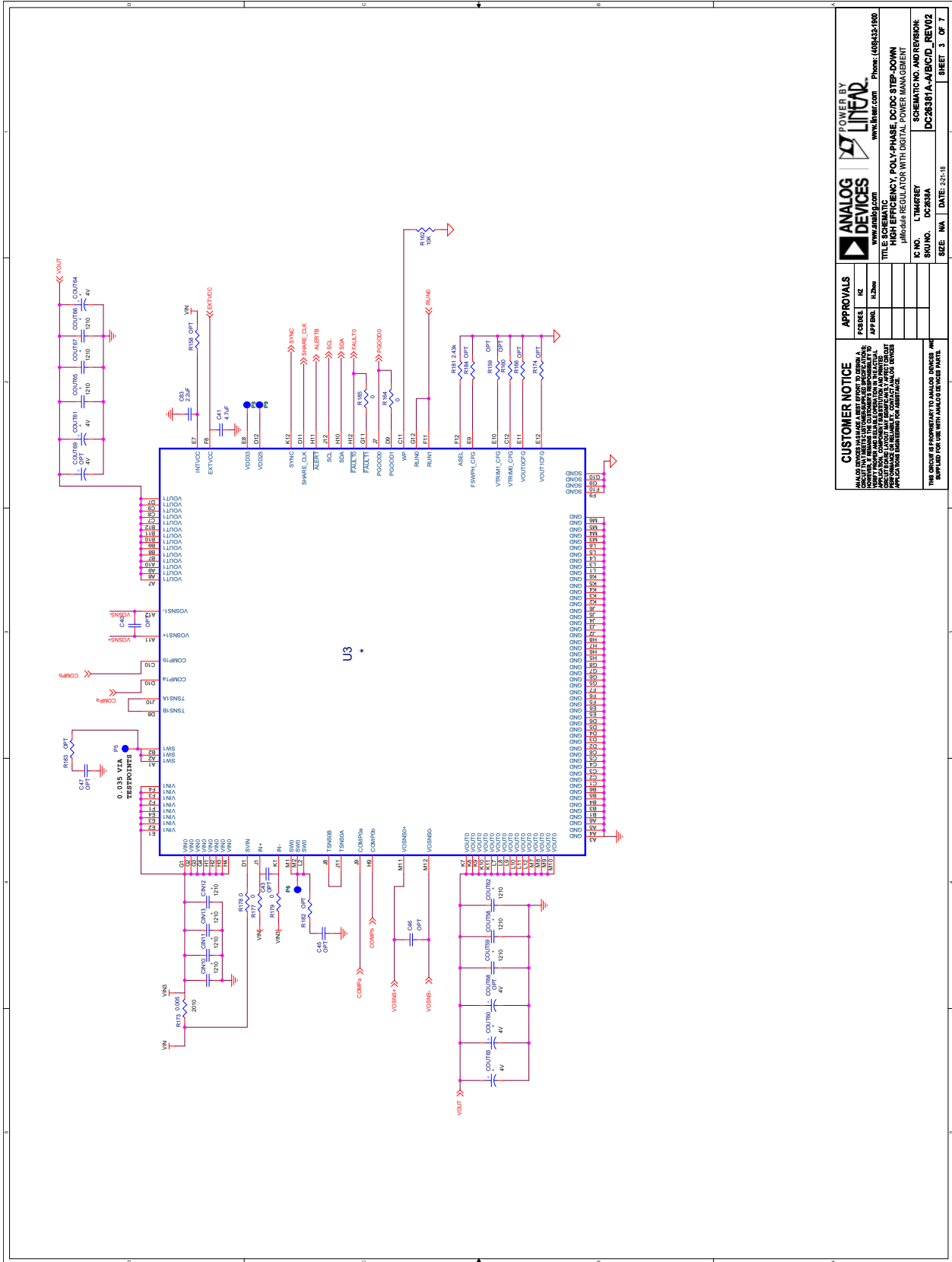

SCHEMATIC DIAGRAM

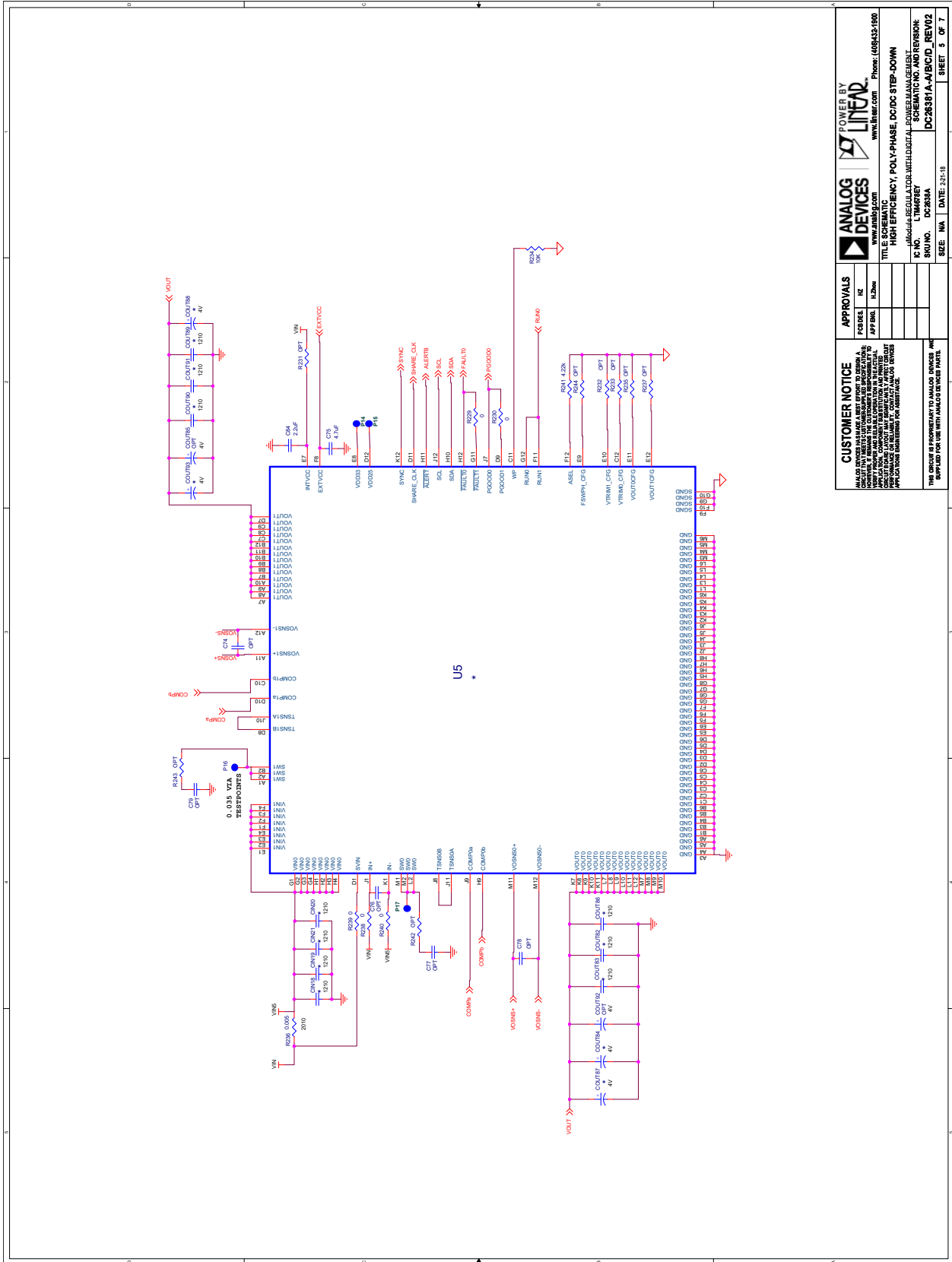

CUSTOMER NOTICE		APPROVALS	
<p>ALL INFORMATION CONTAINED HEREIN IS UNCLASSIFIED EXCEPT WHERE SHOWN OTHERWISE. THIS INFORMATION IS UNCLASSIFIED EXCEPT WHERE SHOWN OTHERWISE. THIS INFORMATION IS UNCLASSIFIED EXCEPT WHERE SHOWN OTHERWISE. THIS INFORMATION IS UNCLASSIFIED EXCEPT WHERE SHOWN OTHERWISE.</p>		<p>DATE: 2-21-16</p>	<p>REV: 0</p>
<p>THIS DEVICE IS UNCLASSIFIED EXCEPT WHERE SHOWN OTHERWISE. THIS DEVICE IS UNCLASSIFIED EXCEPT WHERE SHOWN OTHERWISE. THIS DEVICE IS UNCLASSIFIED EXCEPT WHERE SHOWN OTHERWISE. THIS DEVICE IS UNCLASSIFIED EXCEPT WHERE SHOWN OTHERWISE.</p>		<p>DATE: 2-21-16</p>	<p>REV: 0</p>
<p>THIS DEVICE IS UNCLASSIFIED EXCEPT WHERE SHOWN OTHERWISE. THIS DEVICE IS UNCLASSIFIED EXCEPT WHERE SHOWN OTHERWISE. THIS DEVICE IS UNCLASSIFIED EXCEPT WHERE SHOWN OTHERWISE. THIS DEVICE IS UNCLASSIFIED EXCEPT WHERE SHOWN OTHERWISE.</p>		<p>DATE: 2-21-16</p>	<p>REV: 0</p>

ANALOG DEVICES		POWER BY LINEAR	
<p>www.analog.com</p>		<p>www.linear.com</p>	
<p>PHONE: (800) 431-1000</p>		<p>PHONE: (800) 431-1000</p>	
<p>TITLE SCHEMATIC</p>		<p>TITLE SCHEMATIC</p>	
<p>SKU NO. DC2638A</p>		<p>SKU NO. DC2638A</p>	
<p>DATE: 2-21-16</p>		<p>DATE: 2-21-16</p>	
<p>REV: 0</p>		<p>REV: 0</p>	
<p>REV: 0</p>		<p>REV: 0</p>	

ANALOG DEVICES		POWER BY LINEAR	
<p>www.analog.com</p>		<p>www.linear.com</p>	
<p>PHONE: (800) 431-1000</p>		<p>PHONE: (800) 431-1000</p>	
<p>TITLE SCHEMATIC</p>		<p>TITLE SCHEMATIC</p>	
<p>SKU NO. DC2638A</p>		<p>SKU NO. DC2638A</p>	
<p>DATE: 2-21-16</p>		<p>DATE: 2-21-16</p>	
<p>REV: 0</p>		<p>REV: 0</p>	
<p>REV: 0</p>		<p>REV: 0</p>	

ANALOG DEVICES		POWER BY LINEAR	
<p>www.analog.com</p>		<p>www.linear.com</p>	
<p>PHONE: (800) 431-1000</p>		<p>PHONE: (800) 431-1000</p>	
<p>TITLE SCHEMATIC</p>		<p>TITLE SCHEMATIC</p>	
<p>SKU NO. DC2638A</p>		<p>SKU NO. DC2638A</p>	
<p>DATE: 2-21-16</p>		<p>DATE: 2-21-16</p>	
<p>REV: 0</p>		<p>REV: 0</p>	
<p>REV: 0</p>		<p>REV: 0</p>	

ANALOG DEVICES		POWER BY LINEAR	
<p>www.analog.com</p>		<p>www.linear.com</p>	
<p>PHONE: (800) 431-1000</p>		<p>PHONE: (800) 431-1000</p>	
<p>TITLE SCHEMATIC</p>		<p>TITLE SCHEMATIC</p>	
<p>SKU NO. DC2638A</p>		<p>SKU NO. DC2638A</p>	
<p>DATE: 2-21-16</p>		<p>DATE: 2-21-16</p>	
<p>REV: 0</p>		<p>REV: 0</p>	
<p>REV: 0</p>		<p>REV: 0</p>	

ANALOG DEVICES		POWER BY LINEAR	
<p>www.analog.com</p>		<p>www.linear.com</p>	
<p>PHONE: (800) 431-1000</p>		<p>PHONE: (800) 431-1000</p>	
<p>TITLE SCHEMATIC</p>		<p>TITLE SCHEMATIC</p>	
<p>SKU NO. DC2638A</p>		<p>SKU NO. DC2638A</p>	
<p>DATE: 2-21-16</p>		<p>DATE: 2-21-16</p>	
<p>REV: 0</p>		<p>REV: 0</p>	
<p>REV: 0</p>		<p>REV: 0</p>	

ANALOG DEVICES		POWER BY LINEAR	
<p>www.analog.com</p>		<p>www.linear.com</p>	
<p>PHONE: (800) 431-1000</p>		<p>PHONE: (800) 431-1000</p>	
<p>TITLE SCHEMATIC</p>		<p>TITLE SCHEMATIC</p>	
<p>SKU NO. DC2638A</p>		<p>SKU NO. DC2638A</p>	
<p>DATE: 2-21-16</p>		<p>DATE: 2-21-16</p>	
<p>REV: 0</p>		<p>REV: 0</p>	
<p>REV: 0</p>		<p>REV: 0</p>	

ANALOG DEVICES		POWER BY LINEAR	
<p>www.analog.com</p>		<p>www.linear.com</p>	
<p>PHONE: (800) 431-1000</p>		<p>PHONE: (800) 431-1000</p>	
<p>TITLE SCHEMATIC</p>		<p>TITLE SCHEMATIC</p>	
<p>SKU NO. DC2638A</p>		<p>SKU NO. DC2638A</p>	
<p>DATE: 2-21-16</p>		<p>DATE: 2-21-16</p>	
<p>REV: 0</p>		<p>REV: 0</p>	
<p>REV: 0</p>		<p>REV: 0</p>	

ANALOG DEVICES		POWER BY LINEAR	
<p>www.analog.com</p>		<p>www.linear.com</p>	
<p>PHONE: (800) 431-1000</p>		<p>PHONE: (800) 431-1000</p>	
<p>TITLE SCHEMATIC</p>		<p>TITLE SCHEMATIC</p>	
<p>SKU NO. DC2638A</p>		<p>SKU NO. DC2638A</p>	
<p>DATE: 2-21-16</p>		<p>DATE: 2-21-16</p>	
<p>REV: 0</p>		<p>REV: 0</p>	
<p>REV: 0</p>		<p>REV: 0</p>	

ANALOG DEVICES		POWER BY LINEAR	
<p>www.analog.com</p>		<p>www.linear.com</p>	
<p>PHONE: (800) 431-1000</p>		<p>PHONE: (800) 431-1000</p>	
<p>TITLE SCHEMATIC</p>		<p>TITLE SCHEMATIC</p>	
<p>SKU NO. DC2638A</p>		<p>SKU NO. DC2638A</p>	
<p>DATE: 2-21-16</p>		<p>DATE: 2-21-16</p>	
<p>REV: 0</p>		<p>REV: 0</p>	
<p>REV: 0</p>		<p>REV: 0</p>	

DEMO MANUAL DC2638A-C

SCHEMATIC DIAGRAM

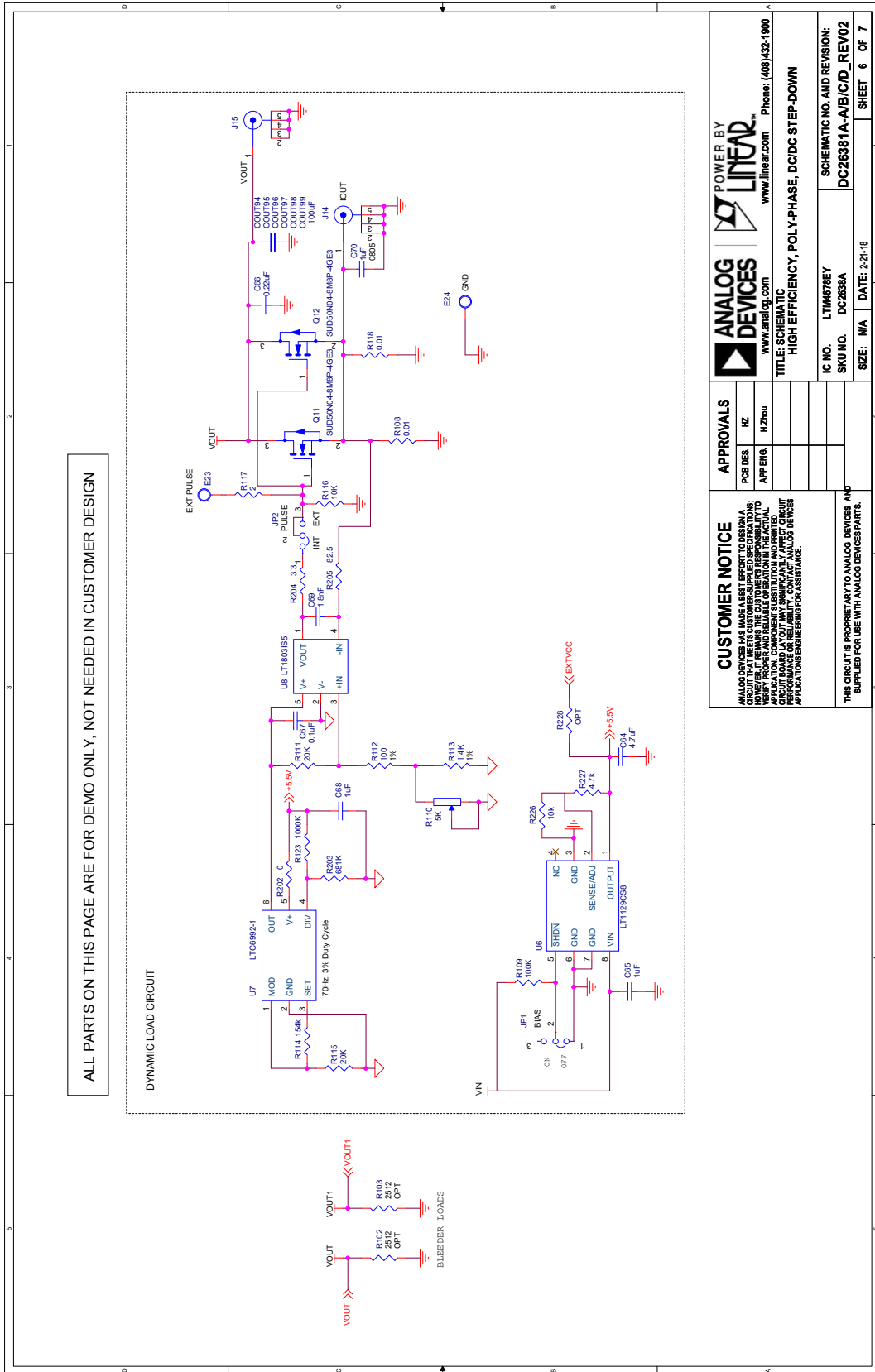

SCHEMATIC DIAGRAM

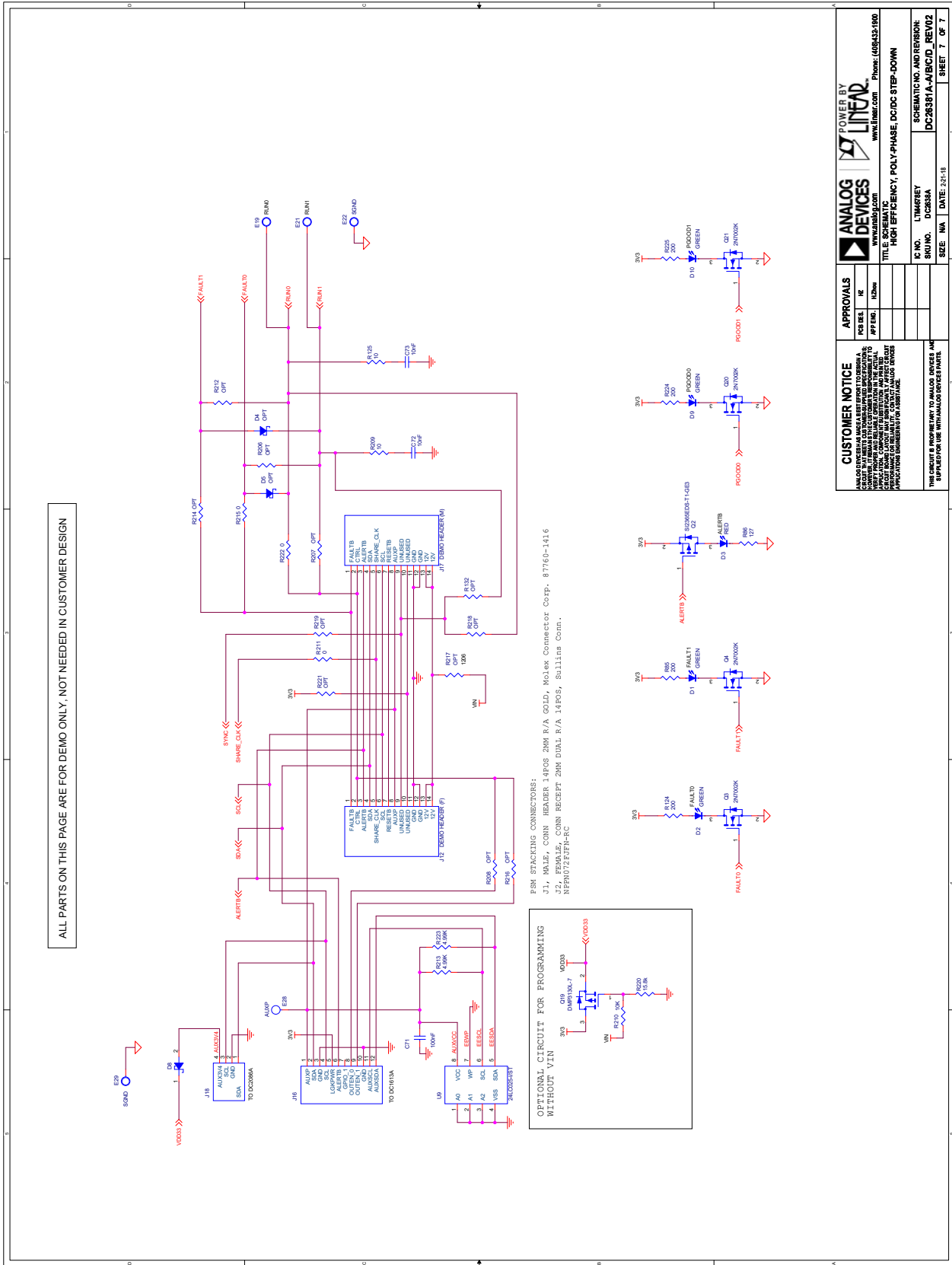

APPROVALS		POWER BY ANALOG DEVICES www.analog.com	LINEAD www.linead.com Phone: (408)433-1800
DESIGNER	IC		
APP NO.	142996	TITLE: SCHEMATIC	
		PROJECT EFFICIENCY, POLY-PHASE, DC/DC STEP-DOWN	
		K. NO. UTMERREY	
		SKU NO. DC2638A	
		SCHEMATIC NO. AND REVISION: DC2638A-A/B/C/D _ REV02	
DATE: 2-21-16	SEE WA	SHEET 7 OF 7	

CUSTOMER NOTICE
THIS SCHEMATIC IS FOR DEMO PURPOSES ONLY. ANALOG DEVICES DOES NOT WARRANT THE ACCURACY OF THE INFORMATION CONTAINED HEREIN. CUSTOMERS SHOULD VERIFY THE INFORMATION CONTAINED HEREIN AGAINST THE ACTUAL DEVICE AND THE ACTUAL BOARD. ANALOG DEVICES IS NOT RESPONSIBLE FOR ANY DAMAGE TO PROPERTY OR PERSONS ARISING FROM THE USE OF THIS SCHEMATIC OR THE INFORMATION CONTAINED HEREIN.

THIS SCHEMATIC IS PROVIDED AS IS. ANALOG DEVICES DOES NOT WARRANT THE ACCURACY OF THE INFORMATION CONTAINED HEREIN. CUSTOMERS SHOULD VERIFY THE INFORMATION CONTAINED HEREIN AGAINST THE ACTUAL DEVICE AND THE ACTUAL BOARD. ANALOG DEVICES IS NOT RESPONSIBLE FOR ANY DAMAGE TO PROPERTY OR PERSONS ARISING FROM THE USE OF THIS SCHEMATIC OR THE INFORMATION CONTAINED HEREIN.

DEMO MANUAL DC2638A-C

PARTS LIST

ITEM	QTY	REFERENCE	PART DESCRIPTION	MANUFACTURER/PART NUMBER
Required Circuit Components				
1	1	CIN1	CAP, 150µF, ALUM. ELECT., 35V, 20%, 8mm x 10.2mm SMD, RADIAL, AEC-Q200	PANASONIC, EEHZA1V151P
2	30	COUT1, COUT2, COUT3, COUT6, COUT7, COUT8, COUT46, COUT47, COUT49, COUT52, COUT53, COUT55, COUT58, COUT59, COUT62, COUT65, COUT66, COUT67, COUT70, COUT71, COUT74, COUT77, COUT78, COUT79, COUT94, COUT95, COUT96, COUT97, COUT98, COUT99	CAP, 100µF, X5R, 6.3V, 20%, 1210	AVX, 12106D107MAT2A MURATA, GRM32ER60J107ME20L TDK, C3225X5R0J107M250AC
3	16	CIN2, CIN3, CIN4, CIN5, CIN6, CIN7, CIN8, CIN9, CIN10, CIN11, CIN12, CIN13, CIN14, CIN15, CIN16, CIN17	CAP, 22µF, X5R, 25V, 10%, 1210	AVX, 12103D226KAT2A MURATA, GRM32ER61E226KE15L TAIYO YUDEN, TMK325BJ226KM-P TAIYO YUDEN, TMK325BJ226KM-T
4	16	COUT4, COUT9, COUT10, COUT11, COUT48, COUT50, COUT54, COUT56, COUT60, COUT61, COUT63, COUT64, COUT72, COUT73, COUT75, COUT80	CAP, 470µF, TANT. POSCAP, 4V, 20%, 7343, 10mΩ, TPF, NO SUBS. ALLOWED	PANASONIC, 4TPF470ML
5	0	COUT5, COUT12, COUT51, COUT57, COUT68, COUT69, COUT76, COUT81, COUT84, COUT85, COUT87, COUT88, COUT92, COUT93	CAP, OPTION, D3L	
6	1	C14	CAP, 0.018µF, X7R, 16V, 10%, 0603	AVX, 0603YC183KAT2A KEMET, C0603C183K4RACTU NIC, NMC0603X7R183K16TRPF
7	1	C15	CAP, 220pF, X7R, 16V, 10%, 0603	AVX, 0603YC221KAT2A KEMET, C0603C221K4RACTU NIC, NMC0603X7R221K16TRPF
10	6	C30, C41, C49, C64, C75, C85	CAP, 4.7µF, X5R, 25V, 10%, 0603, NO SUBS. ALLOWED	MURATA, GRM188R61E475KE11D
11	2	C65, C68	CAP, 1µF, X7R, 25V, 10%, 1206	AVX, 12063C105KAT2A MURATA, GRM31MR71E105KA01L TAIYO YUDEN, TMK316B7105KL-T TDK, C3216X7R1E105K160AA
12	1	C66	CAP, 0.22µF, X5R, 25V, 10%, 0805	AVX, 08053D224KAT2A TAIYO YUDEN, TMK212BJ224KGHT VENKEL LTD., C0805X5R250-224KNE
13	1	C67	CAP, 0.1µF, X7R, 25V, 10%, 1206	AVX, 12063C104KAT2A NIC, NMC1206X7R104K25TRPF
14	1	C69	CAP, 1800pF, X7R, 16V, 10%, 0603	AVX, 0603YC182KAT2A KEMET, C0603C182K4RACTU NIC, NMC0603X7R182K16TRPF
15	1	C70	CAP, 1µF, X5R, 25V, 10%, 0805	AVX, 08053D105KAT2A MURATA, GRM216R61E105KA12D TDK, CGB4B3X5R1E105K055AB
16	1	C71	CAP, 0.1µF, X7R, 25V, 10%, 0603	AVX, 06033C104KAT2A KEMET, C0603C104K3RACTU NIC, NMC0603X7R104K25TRPF TDK, C1608X7R1E104K080AA
17	2	C72, C73	CAP, 0.01µF, X7R, 25V, 10%, 0603	AVX, 06033C103KAT2A MURATA, GRM188R71E103KA01D YAGEO, CC0603KRX7R8BB103
18	5	C80, C81, C82, C83, C84	CAP, 2.2µF, X7R, 25V, 10%, 0603	MURATA, GRM188Z71E225KE43D
19	4	D1, D2, D9, D10	LED, GREEN, WATERCLEAR, 0603	WURTH ELEKTRONIK, 150060GS75000

Rev. 0

PARTS LIST

ITEM	QTY	REFERENCE	PART DESCRIPTION	MANUFACTURER/PART NUMBER
Required Circuit Components				
20	1	D3	LED, SUPER RED, WATERCLEAR, 0603	WURTH ELEKTRONIK, 150060SS75000
22	1	D8	DIODE, SCHOTTKY RECT., 20V, 0.5A, SOD-882D, LEADLESS, 2-TERM.	NEXPERIA, PMEG2005AELD, 315
36	1	Q2	XSTR., MOSFET, P-CH, 20V, 5.9A, TO-236 (SOT23-3)	VISHAY, SI2365EDS-T1-GE3
37	4	Q3, Q4, Q20, Q21	XSTR., MOSFET, SINGLE N-CH, 60V, 380mA, SOT23-3, AEC-Q101	ON SEMICONDUCTOR, 2N7002KT1G
38	2	Q11, Q12	XSTR., MOSFET, N-CH, 40V, TO-252 (DPAK)	VISHAY, SUD50N04-8M8P-4GE3
39	1	Q19	XSTR., MOSFET, P-CH, 30V, 3.5A, SOT23-3, AEC-Q101	DIODES INC., DMP3130L-7
41	36	R9, R33, R91, R92, R106, R107, R127, R128, R129, R146, R147, R148, R149, R150, R151, R152, R164, R177, R178, R179, R185, R186, R187, R195, R196, R197, R202, R211, R215, R222, R229, R230, R238, R239, R240, R245	RES., 0Ω, 1/10W, 0603, AEC-Q200	NIC, NRC06ZOTRF VISHAY, CRCW06030000Z0EA
42	20	R10, R11, R12, R13, R14, R15, R16, R18, R24, R95, R116, R136, R137, R138, R145, R162, R191, R210, R226, R234	RES., 10k, 1%, 1/10W, 0603, AEC-Q200	KOA SPEER, RK73H1JTTD1002F PANASONIC, ERJ3EKF1002V VISHAY, CRCW060310K0FKEA
43	4	R25, R32, R125, R209	RES., 10Ω, 1%, 1/10W, 0603	NIC, NRC06F10R0TRF PANASONIC, ERJ3EKF10R0V ROHM, MCR03EZPFX10R0 VISHAY, CRCW060310R0FKEA YAGEO, RC0603FR-0710RL
44	1	R26	RES., 787Ω, 1%, 1/10W, 0603, AEC-Q200	NIC, NRC06F7870TRF PANASONIC, ERJ3EKF7870V VISHAY, CRCW0603787RFKEA
45	4	R85, R124, R224, R225	RES., 200Ω, 1%, 1/10W, 0603	NIC, NRC06F2000TRF VISHAY, CRCW0603200RFKEA YAGEO, RC0603FR-07200RL
46	1	R86	RES., 127Ω, 1%, 1/10W, 0603, AEC-Q200	NIC, NRC06F1270TRF PANASONIC, ERJ3EKF1270V VISHAY, CRCW0603127RFKEA
47	5	R90, R126, R173, R193, R236	RES., 0.005Ω, 1%, 1/2W, 2010, SENSE, AEC-Q200	VISHAY, WSL20105L000FEA
49	2	R108, R118	RES., 0.01Ω, 1%, 1/2W, 2010, SENSE, AEC-Q200	VISHAY, WSL2010R0100FEA
50	1	R109	RES., 100k OHMS, 1%, 1/10W, 0603, AEC-Q200	NIC, NRC06F1003TRF PANASONIC, ERJ3EKF1003V VISHAY, CRCW0603100KFKEA
51	1	R110	RES., 5k, 10%, 1/2W, THT 3/8 SQ, 1-TURN, TOP ADJ., TRIMPOT	
52	2	R111, R115	RES., 20k, 1%, 1/10W, 0603	PANASONIC, ERJ3EKF2002V VISHAY, CRCW060320K0FKEA YAGEO, RC0603FR-0720KL
53	1	R112	RES., 100Ω, 1%, 1/10W, 0603, AEC-Q200	NIC, NRC06F1000TRF PANASONIC, ERJ3EKF1000V VISHAY, CRCW0603100RFKEA
54	1	R113	RES., 1.4k, 1%, 1/10W, 0603, AEC-Q200	NIC, NRC06F1401TRF PANASONIC, ERJ3EKF1401V VISHAY, CRCW06031K40FKEA
55	1	R114	RES., 154k, 1%, 1/10W, 0603, AEC-Q200	NIC, NRC06F1543TRF PANASONIC, ERJ3EKF1543V VISHAY, CRCW0603154KFKEA

DEMO MANUAL DC2638A-C

PARTS LIST

ITEM	QTY	REFERENCE	PART DESCRIPTION	MANUFACTURER/PART NUMBER
Required Circuit Components				
56	1	R117	RES., 2Ω, 1%, 1/10W, 0603, AEC-Q200	VISHAY, CRCW06032R00FKEA
57	1	R123	RES., 1MΩ, 1%, 1/10W, 0603, AEC-Q200	NIC, NRC06F1004TRF PANASONIC, ERJ3EKF1004V VISHAY, CRCW06031M00FKEA
58	1	R139	RES., 1.65k, 1%, 1/10W, 0603, AEC-Q200	NIC, NRC06F1651TRF PANASONIC, ERJ3EKF1651V VISHAY, CRCW06031K65FKEA
59	4	R153, R154, R155, R156	RES., 0Ω, 3/4W, 2010, AEC-Q200	NIC, NRC50ZOTRF PANASONIC, ERJ12ZY0R00U VISHAY, CRCW20100000Z0EF
60	1	R181	RES., 2.43k, 1%, 1/10W, 0603, AEC-Q200	NIC, NRC06F2431TRF PANASONIC, ERJ3EKF2431V VISHAY, CRCW06032K43FKEA
61	1	R198	RES., 3.24k, 1%, 1/10W, 0603, AEC-Q200	NIC, NRC06F3241TRF PANASONIC, ERJ3EKF3241V VISHAY, CRCW06033K24FKEA
62	1	R203	RES., 681k, 1%, 1/10W, 0603, AEC-Q200	NIC, NRC06F6813TRF PANASONIC, ERJ3EKF6813V VISHAY, CRCW0603681K3FKEA
63	1	R204	RES., 3.3Ω, 1%, 1/10W, 0603, AEC-Q200	VISHAY, CRCW06033R30FKEA
64	1	R205	RES., 82.5Ω, 1%, 1/10W, 0603, AEC-Q200	NIC, NRC06F82R5TRF PANASONIC, ERJ3EKF82R5V VISHAY, CRCW060382R5FKEA
65	2	R213, R223	RES., 4.99k, 1%, 1/10W, 0603, AEC-Q200	NIC, NRC06F4991TRF PANASONIC, ERJ3EKF4991V VISHAY, CRCW06034K99FKEA
66	1	R220	RES., 15.8k, 1%, 1/10W, 0603, AEC-Q200	NIC, NRC06F1582TRF PANASONIC, ERJ3EKF1582V VISHAY, CRCW060315K8FKEA
67	1	R227	RES., 4.7k, 1%, 1/10W, 0603, AEC-Q200	NIC, NRC06F4701TRF PANASONIC, ERJ3EKF4701V VISHAY, CRCW06034K70FKEA
68	1	R241	RES., 4.22k, 1%, 1/10W, 0603, AEC-Q200	NIC, NRC06F4221TRF PANASONIC, ERJ3EKF4221V VISHAY, CRCW06034K22FKEA
69				
70	4	U1, U2, U3, U4	IC, DUAL 25A POP PSM MODULE, BGA-144	ANALOG DEVICES, LTM4678EY#PBF
71	1	U6	IC, 700mA μPOWER LDO WITH SHUTDOWN, SO-8	ANALOG DEVICES, LT1129CS8#PBF ANALOG DEVICES, LT1129CS8#TRPBF
72	1	U7	IC, TIMERBLOX: VOLTAGE-CTRL. PWM, TSOT23-6	ANALOG DEVICES, LTC6992CS6-1#PBF ANALOG DEVICES, LTC6992CS6-1#TRMPBF ANALOG DEVICES, LTC6992CS6-1#TRPBF
73	1	U8	IC, SINGLE R TO R IN/OUT OP AMP, TSOT23-5, 100V/μs, 85MHz	ANALOG DEVICES, LT1803IS5#PBF ANALOG DEVICES, LT1803IS5#TRMPBF ANALOG DEVICES, LT1803IS5#TRPBF
74	1	U9	IC, MEMORY, EEPROM, 2Kb (256x8), TSSOP-8, 400kHz	MICROCHIP, 24LC025-I/ST MICROCHIP, 24LC025T-I/ST

PARTS LIST

ITEM	QTY	REFERENCE	PART DESCRIPTION	MANUFACTURER/PART NUMBER
Additional Demo Board Circuit Components				
1	0	C16, C17, C29, C31, C32, C33, C34, C35, C36, C37, C38, C39, C40, C43, C45, C46, C47, C48, C50, C51, C52, C53, C74, C76, C77, C78, C79	CAP, OPTION, 0603	
2	0	CIN18,CIN19,CIN20,CIN21COUT82,COUT83,COUT86,COUT89,COUT90,COUT91	CAP, OPTION, 1210	
3	0	D4, D5	DIODE, OPTION, SOD-323	
4	0	R8, R27, R28, R29, R30, R31, R104, R105, R130, R131, R132, R133, R134, R135, R140, R141, R142, R143, R144, R158, R159, R160, R166, R174, R182, R183, R184, R188, R189, R190, R192, R194, R199, R200, R201, R206, R207, R208, R212, R214, R216, R218, R219, R221, R228, R231, R232, R233, R235, R237, R242, R243, R244	RES., OPTION, 0603	
5	0	R217	RES., OPTION, 1206	
6	0	R102, R103	RES., OPTION, 2512	
7	0	U5	IC., OPTION, BGA-144	
8	0		PCA ASSY DWG, DC2638A	
Hardware: For Demo Board Only				
1	27	E1, E2, E3, E4, E5, E6, E7, E8, E9, E10, E11, E12, E13, E14, E15, E16, E17, E20, E21, E22, E23, E24, E25, E26, E27, E28, E29	TEST POINT, TURRET, 0.064, MTG. HOLE	MILL-MAX, 2308-2-00-80-00-00-07-0
2	2	JP1, JP2	CONN., HDR, MALE, 1x3, 2mm, VERT, STR, THT	WURTH ELEKTRONIK, 62000311121
3	8	J5, J7, J8, J9, J10, J13, J19, J20	RING, LUG, CRIMP, #10, NON-INSULATED, SOLDERLESS TERMINALS	KEYSTONE, 8205
4	16	J5, J7, J8, J9, J10, J13, J19, J20	NUT, HEX, STEEL, ZINC PLATE, 10-32	KEYSTONE, 4705
5	8	J5, J7, J8, J9, J10, J13, J19, J20	WASHER, FLAT, STEEL, ZINC PLATE, OD: 0.436 [11.1]	KEYSTONE, 4703
6	8	J5, J7, J8, J9, J10, J13, J19, J20	STUD, FASTENER, #10-32	PENNINGENGINEERING, KFH-032-10ET
7	1	J12	CONN., HDR, FEMALE, 2x7, 2mm, R/A THT	SULLINS CONNECTOR SOLUTIONS, NPPN072FJFN-RC
8	2	J14, J15	CONN., RF,BNC, RCPT JACK, 5-PIN, STR, THT, 50 OHMS	AMPHENOL RF, 112404
9	1	J16	CONN., SHROUDED HDR, MALE, 2x6, 2mm, VERT, STR, THT	FCI, 98414-G06-12ULF
10	1	J17	CONN., HDR, MALE, 2x7, 2mm, R/A THT	MOLEX, 0877601416 MOLEX, 87760-1416
11	1	J18	CONN., SHROUDED HDR, MALE, 1x4, 2mm, VERT, STR, THT	HIROSE ELECTRIC, DF3A-4P-2DSA
12	1	LB1	LABEL SPEC, DEMO BOARD SERIAL NUMBER	BRADY, THT-96-717-10
13	2	SW0, SW1	CONN., HDR., MALE, 1x3, 2mm, VERT, STR, THT, 10μ Au	SAMTEC, TMM-103-02-L-S
14	4	MH1, MH2, MH3, MH4	STANDOFF, NYLON, SNAP-ON, 0.50	WURTH ELEKTRONIK, 702935000
15	2	XJP1, XJP2	CONN., SHUNT, FEMALE, 2-POS, 2mm	WURTH ELEKTRONIK, 60800213421
16				
17	1		PCB, DC2638A	MAO BANG, 600-DC2638A
18	1		TOOL, STENCIL, 700-DC2638A	ANALOG DEVICES, 830-DC2638A



ESD Caution

ESD (electrostatic discharge) sensitive device. Charged devices and circuit boards can discharge without detection. Although this product features patented or proprietary protection circuitry, damage may occur on devices subjected to high energy ESD. Therefore, proper ESD precautions should be taken to avoid performance degradation or loss of functionality.

Legal Terms and Conditions

By using the evaluation board discussed herein (together with any tools, components documentation or support materials, the "Evaluation Board"), you are agreeing to be bound by the terms and conditions set forth below ("Agreement") unless you have purchased the Evaluation Board, in which case the Analog Devices Standard Terms and Conditions of Sale shall govern. Do not use the Evaluation Board until you have read and agreed to the Agreement. Your use of the Evaluation Board shall signify your acceptance of the Agreement. This Agreement is made by and between you ("Customer") and Analog Devices, Inc. ("ADI"), with its principal place of business at One Technology Way, Norwood, MA 02062, USA. Subject to the terms and conditions of the Agreement, ADI hereby grants to Customer a free, limited, personal, temporary, non-exclusive, non-sublicensable, non-transferable license to use the Evaluation Board FOR EVALUATION PURPOSES ONLY. Customer understands and agrees that the Evaluation Board is provided for the sole and exclusive purpose referenced above, and agrees not to use the Evaluation Board for any other purpose. Furthermore, the license granted is expressly made subject to the following additional limitations: Customer shall not (i) rent, lease, display, sell, transfer, assign, sublicense, or distribute the Evaluation Board; and (ii) permit any Third Party to access the Evaluation Board. As used herein, the term "Third Party" includes any entity other than ADI, Customer, their employees, affiliates and in-house consultants. The Evaluation Board is NOT sold to Customer; all rights not expressly granted herein, including ownership of the Evaluation Board, are reserved by ADI. CONFIDENTIALITY. This Agreement and the Evaluation Board shall all be considered the confidential and proprietary information of ADI. Customer may not disclose or transfer any portion of the Evaluation Board to any other party for any reason. Upon discontinuation of use of the Evaluation Board or termination of this Agreement, Customer agrees to promptly return the Evaluation Board to ADI. ADDITIONAL RESTRICTIONS. Customer may not disassemble, decompile or reverse engineer chips on the Evaluation Board. Customer shall inform ADI of any occurred damages or any modifications or alterations it makes to the Evaluation Board, including but not limited to soldering or any other activity that affects the material content of the Evaluation Board. Modifications to the Evaluation Board must comply with applicable law, including but not limited to the RoHS Directive. TERMINATION. ADI may terminate this Agreement at any time upon giving written notice to Customer. Customer agrees to return to ADI the Evaluation Board at that time. LIMITATION OF LIABILITY. THE EVALUATION BOARD PROVIDED HEREUNDER IS PROVIDED "AS IS" AND ADI MAKES NO WARRANTIES OR REPRESENTATIONS OF ANY KIND WITH RESPECT TO IT. ADI SPECIFICALLY DISCLAIMS ANY REPRESENTATIONS, ENDORSEMENTS, GUARANTEES, OR WARRANTIES, EXPRESS OR IMPLIED, RELATED TO THE EVALUATION BOARD INCLUDING, BUT NOT LIMITED TO, THE IMPLIED WARRANTY OF MERCHANTABILITY, TITLE, FITNESS FOR A PARTICULAR PURPOSE OR NON-INFRINGEMENT OF INTELLECTUAL PROPERTY RIGHTS. IN NO EVENT WILL ADI AND ITS LICENSORS BE LIABLE FOR ANY INCIDENTAL, SPECIAL, INDIRECT, OR CONSEQUENTIAL DAMAGES RESULTING FROM CUSTOMER'S POSSESSION OR USE OF THE EVALUATION BOARD, INCLUDING BUT NOT LIMITED TO LOST PROFITS, DELAY COSTS, LABOR COSTS OR LOSS OF GOODWILL. ADI'S TOTAL LIABILITY FROM ANY AND ALL CAUSES SHALL BE LIMITED TO THE AMOUNT OF ONE HUNDRED US DOLLARS (\$100.00). EXPORT. Customer agrees that it will not directly or indirectly export the Evaluation Board to another country, and that it will comply with all applicable United States federal laws and regulations relating to exports. GOVERNING LAW. This Agreement shall be governed by and construed in accordance with the substantive laws of the Commonwealth of Massachusetts (excluding conflict of law rules). Any legal action regarding this Agreement will be heard in the state or federal courts having jurisdiction in Suffolk County, Massachusetts, and Customer hereby submits to the personal jurisdiction and venue of such courts. The United Nations Convention on Contracts for the International Sale of Goods shall not apply to this Agreement and is expressly disclaimed.