

## Evaluation Board for the **SSM2377** Filterless, Class-D Audio Amplifier

### PACKAGE CONTENTS

EVAL-SSM2377Z evaluation board

### OTHER SUPPORTING DOCUMENTATION

[SSM2377 data sheet](#)

### GENERAL DESCRIPTION

The **SSM2377** is a fully integrated, high efficiency, Class-D audio amplifier. It is designed to maximize performance for mobile phone applications. The application circuit requires a minimum of external components and operates from a single 2.5 V to 5.5 V supply. It is capable of delivering 2.5 W of continuous output power with <1% THD + N when driving a 4 Ω load from a 5.0 V supply.

Spread-spectrum pulse density modulation (PDM) is used to provide lower EMI-radiated emissions compared with other Class-D architectures. The inherent randomized nature of spread-spectrum PDM eliminates the clock intermodulation (beating effect) of several amplifiers in close proximity.

The **SSM2377** produces ultralow EMI emissions that significantly reduce the radiated emissions at the Class-D outputs, particularly above 100 MHz. The **SSM2377** passes FCC Class B radiated emission testing with 50 cm, unshielded speaker cable without any external filtering.

The device also includes a gain select pin that allows the user to select a 6 dB or a 12 dB gain. This option improves gain matching between multiple **SSM2377** devices within a single application as compared to using external resistors to set the gain. Input impedance is 80 kΩ and is independent of the gain setting.

This user guide describes how to configure and use the **SSM2377** evaluation board. The user guide should be read in conjunction with the **SSM2377** data sheet, which provides detailed information about the specifications, internal block diagrams, and application guidance for the amplifier IC.

### EVALUATION BOARD OVERVIEW

The **SSM2377** evaluation board carries a complete application circuit for driving a loudspeaker. Figure 1 shows the top view of the evaluation board, and Figure 2 shows the bottom view.

### DIGITAL PICTURES OF THE EVALUATION BOARD

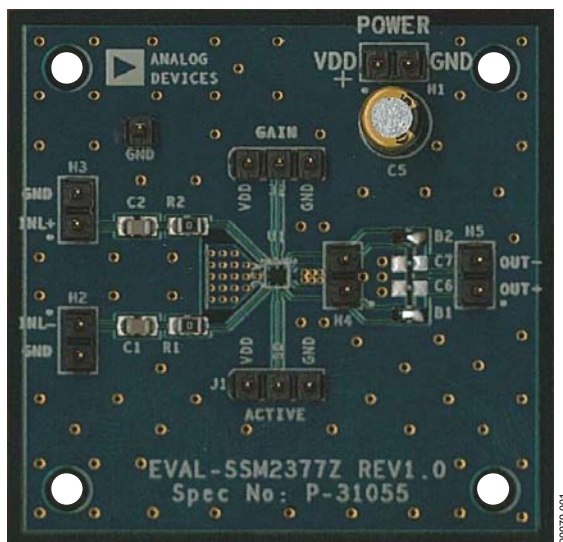

Figure 1. SSM2377 Evaluation Board, Top View

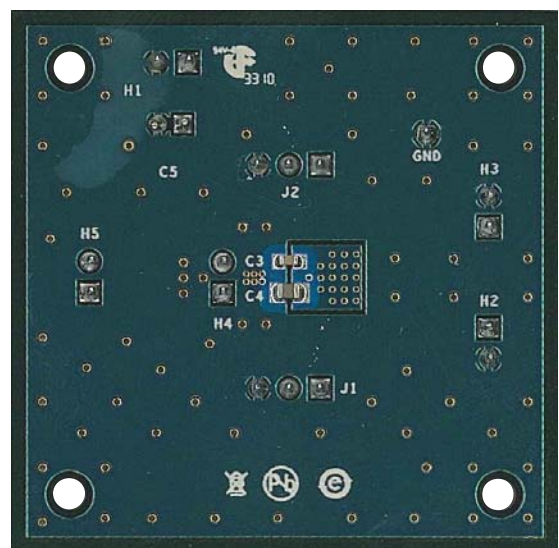

Figure 2. SSM2377 Evaluation Board, Bottom View

**TABLE OF CONTENTS**

Package Contents.....	1	Gain Configuration.....	3
Other Supporting Documentation.....	1	Output Configuration.....	3
General Description.....	1	Power Supply Configuration .....	3
Evaluation Board Overview .....	1	Component Selection .....	3
Digital Pictures of the Evaluation Board.....	1	Getting Started.....	5
Revision History .....	2	What to Test .....	5
Setting Up the Evaluation Board .....	3	Evaluation Board Schematics and Artwork.....	6
Input Configuration .....	3	Ordering Information.....	8
Shutdown Mode.....	3	Bill of Materials.....	8

**REVISION HISTORY**

**6/11—Revision 0: Initial Version**

## SETTING UP THE EVALUATION BOARD

### INPUT CONFIGURATION

A pair of 2-pin, 0.100" headers (H2 and H3) on the left side of the board feed the audio signal into the board (see Figure 1). If the input audio signal is differential, three header pins are used: INL+, INL–, and either GND terminal for input signal ground. For a single-ended audio input, use INL+ and GND for input signal and ground, respectively. Use a jumper to short INL– to GND. If the opposite input polarity is required, use INL– and GND for input signal and ground, respectively.

### SHUTDOWN MODE

J1, the 3-pin header labeled ACTIVE, is used to turn the [SSM2377](#) amplifier on and off. Placing a jumper between the SD and VDD header pins places the [SSM2377](#) in normal operation. Placing the jumper between the SD and GND header pins shuts down the [SSM2377](#) so that only a minimum current (approximately 20 nA) is drawn from the power supply. Because there is no internal pull-up or pull-down, do not omit the jumper; leaving the SD pin floating puts the part in an indeterminate state.

### GAIN CONFIGURATION

A 3-pin header, J2, controls the analog gain of the [SSM2377](#). By placing a jumper across two pins of J2, the amplifier GAIN pin can be connected to GND or VDD. Two jumper settings are used: between the center pin and the right pin (GND), or between the center pin and the left pin (VDD). See Table 1 for configuration instructions.

**Table 1. Gain Configuration**

Gain Setting (dB)	J2 Configuration
6	Tie center pin to VDD
12	Tie center pin to GND

### OUTPUT CONFIGURATION

Two output headers, H4 and H5, are located on the right side of the board before and after a ferrite bead output filter (see Figure 1). Either header can be connected to a loudspeaker; the loudspeaker impedance should be no less than 4 Ω.

Because the [SSM2377](#) does not typically require any external LC output filters due to a low noise modulation scheme, no output filter is installed on the evaluation board. In this case, use thick wire to short across the pads marked B1 and B2, leave the capacitor pads unpopulated, and connect the speaker to H5. To minimize trace lengths, use H4 instead of H5.

If the speaker cable length exceeds 50 cm, place ferrite beads B1 and B2 in the output paths and use capacitors C6 and C7 to couple the output terminals to ground, as shown in the schematic in Figure 3. In this case, Header H5 must be used for the output terminals. Recommended ferrite beads are listed in Table 2. For applications with specific EMI vs. audio performance constraints, users may want to use inductors; see Table 3 for recommended inductors.

For the best THD and SNR performance as specified in the [SSM2377](#) data sheet, do not use an output filter.

### POWER SUPPLY CONFIGURATION

The 2-pin Header H1 is used to power the board. Care must be taken to connect the dc power with correct polarity and voltage. Reverse polarity or overvoltage may permanently damage the board. The maximum supply current is approximately 0.33 A when driving an 8 Ω load with an input voltage of 5 V. Do not allow VDD to exceed 5.5 V.

### COMPONENT SELECTION

Selecting the proper components is the key to achieving the performance required at the budgeted cost.

#### Input Gain Resistor Selection—R1 and R2

If the desired gain must be adjusted beyond the available gain settings (see the Gain Configuration section), a series resistor can be placed in the input signal path. This resistor creates a voltage divider with the 80 kΩ input resistance on each input pin, allowing an arbitrary reduction of the input signal. Because input signal attenuation directly reduces SNR performance, large values compared to the built-in input resistance should be avoided. These components are populated with 0 Ω values on the evaluation board.

#### Input Coupling Capacitor Selection—C1 and C2

The input coupling capacitors, C1 and C2, should be large enough to couple the low frequency signal components in the incoming signal but small enough to reject unnecessary, extremely low frequency signals. For music signals, the cutoff frequency is typically between 20 Hz and 30 Hz. The value of the input capacitor is calculated as follows:

$$C = 1/(2\pi \times R_{IN} \times f_c)$$

where:

$$R_{IN} = 80 \text{ k}\Omega + (R1 \text{ or } R2).$$

$f_c$  is the desired cutoff frequency.

#### Output Ferrite Beads—B1 and B2

The output beads, B1 and B2, are necessary components for filtering out the EMI caused at the switching output nodes when the length of the speaker wire is greater than 50 cm. The penalty for using ferrite beads for EMI filtering is slightly worse noise and distortion performance at the system level due to the nonlinearity of the beads.

Ensure that these beads have enough current-conducting capability while providing sufficient EMI attenuation. The current rating needed for an 8 Ω load is approximately 420 mA, and impedance at 100 MHz should be  $\geq 120 \Omega$ . In addition, the lower the dc resistance (DCR) of these beads, the better for minimizing their power consumption. Table 2 lists the recommended beads.

**Output Shunting Capacitors**

Two output shunting capacitors, C6 and C7, work with the ferrite beads, B1 and B2. Use small size (0603 or 0402), multilayer ceramic capacitors that are made of X7R or C0G (NPO) materials. For the simplest BOM, a single capacitor of approximately 470 pF can be used. Alternatively, for improved performance, a small capacitor (approximately 100 pF) plus a larger capacitor (less than 1 nF) can be placed in parallel. This configuration provides thorough EMI reduction for the entire frequency spectrum.

**Output Inductors**

If you prefer inductors for the purpose of EMI filtering at the output nodes, choose an inductor value that is  $<2.2 \mu\text{H}$ . The higher the inductance, the lower the EMI is at the output. However, the cost and power consumption of the inductors are higher. Using  $0.47 \mu\text{H}$  to  $2.2 \mu\text{H}$  inductors is recommended, and the current rating (and saturation current) should exceed 600 mA for an  $8 \Omega$  load. Table 3 lists the recommended inductors.

**Table 2. Recommended Output Beads**

Part No.	Manufacturer	Z ( $\Omega$ )	I <sub>MAX</sub> (mA)	DCR ( $\Omega$ )	Size (mm)
BLM18PG121SN1D	Murata	120	2000	0.05	1.6 × 0.8 × 0.8
MPZ1608S101A	TDK	100	3000	0.03	1.6 × 0.8 × 0.8
MPZ1608S221A	TDK	220	2200	0.05	1.6 × 0.8 × 0.8
BLM18EG221SN1D	Murata	220	2000	0.05	1.6 × 0.8 × 0.8

**Table 3. Recommended Output Inductors**

Part No.	Manufacturer	L ( $\mu\text{H}$ )	I <sub>MAX</sub> (mA)	DCR ( $\Omega$ )	Size (mm)
LQM31PNR47M00	Murata	0.47	1400	0.07	3.2 × 1.6 × 0.85
LQM31PN1R0M00	Murata	1.0	1200	0.15	3.2 × 1.6 × 0.85
LQM21PNR47MC0	Murata	0.47	1100	0.15	2.0 × 1.25 × 0.5
LQM21PN1R0MC0	Murata	1.0	800	0.2375	2.0 × 1.25 × 0.5
LQH32CN2R2M53	Murata	2.2	790	0.1	3.2 × 2.5 × 1.55

## GETTING STARTED

To ensure proper operation, carefully follow Step 1 through Step 6.

1. To enable the amplifier, use a jumper to tie the center pin of J1 to VDD.
2. To choose a gain setting, use a jumper to tie the center pin of J2 to either VDD (6 dB) or GND (12 dB).
3. For most audio quality testing, any EMI filtering should be removed. Remove Capacitors C6 and C7, if populated, and short across the B1 and B2 terminals with thick wire to make a direct connection from the device output to the H5 speaker header.
4. Connect the load to H5.
5. Connect the audio input to the board in either differential mode or single-ended mode, depending on the application.
6. Connect the power supply with the proper polarity and voltage.

## WHAT TO TEST

- Electromagnetic interference (EMI)—connect wires for the speakers, making sure that they are the same length as the wires required for the actual application environment; then complete the EMI test.
- Signal-to-noise ratio.
- Output noise—make sure to use an A-weighted filter to filter the output before reading the measurement meter.
- Maximum output power.
- Distortion.
- Efficiency.

EVALUATION BOARD SCHEMATICS AND ARTWORK

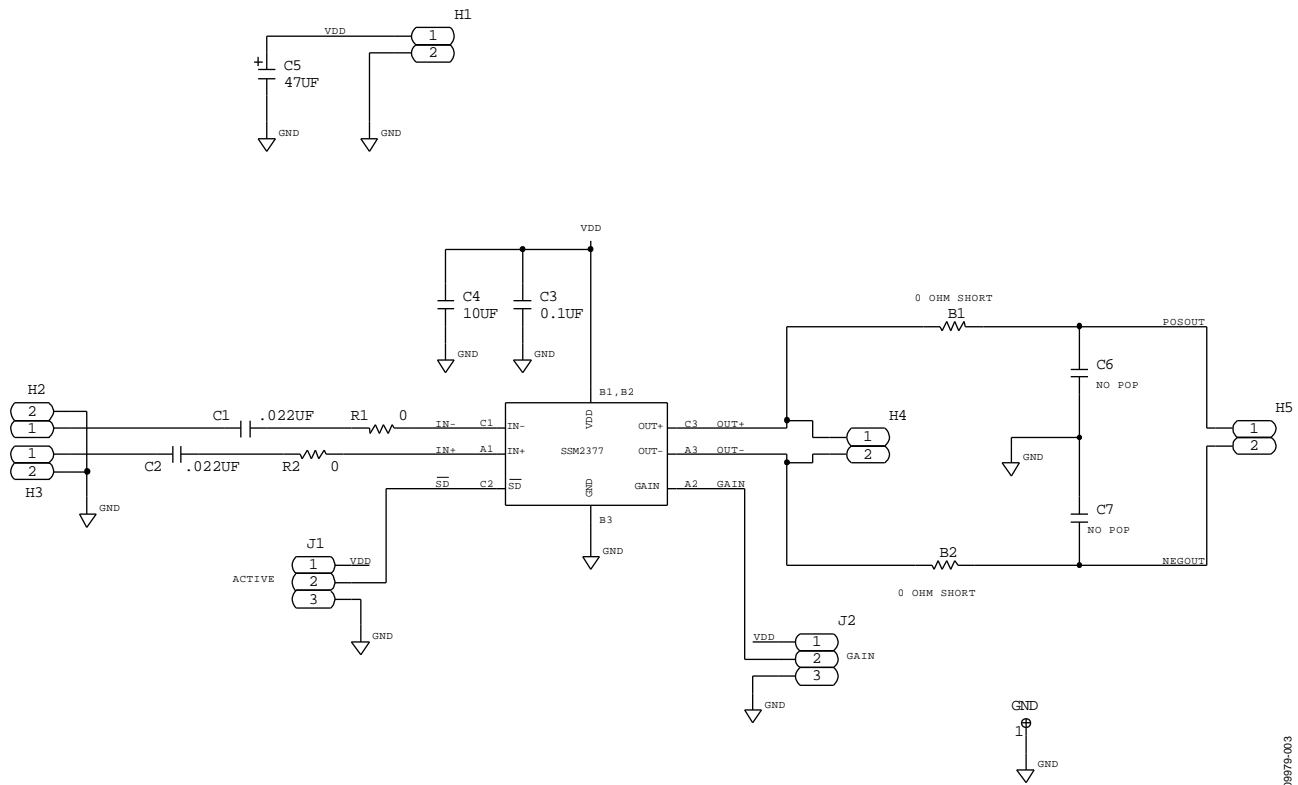

Figure 3. Schematic of the SSM2377 Evaluation Board

06979-003

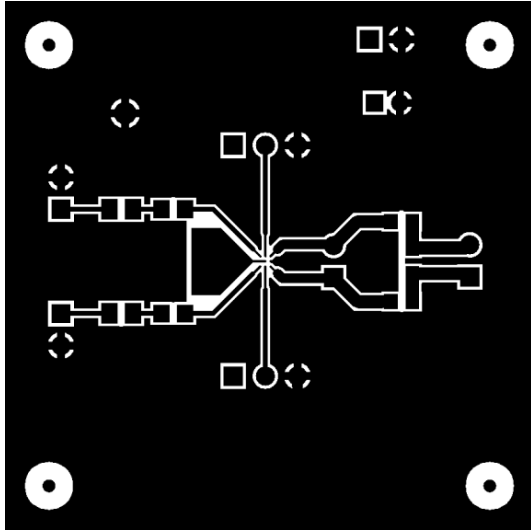

Figure 4. Top Layer Copper

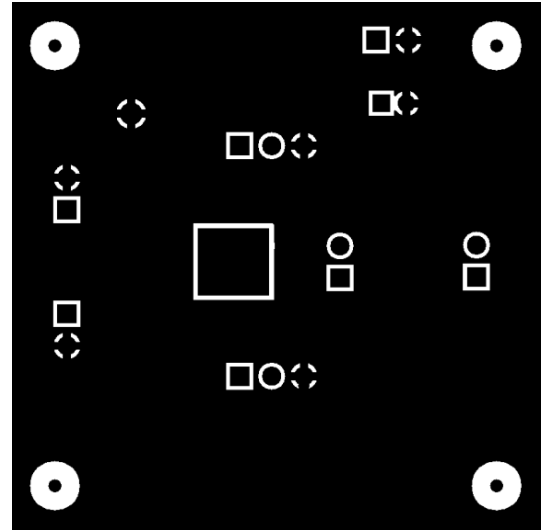

Figure 7. Bottom Layer Copper

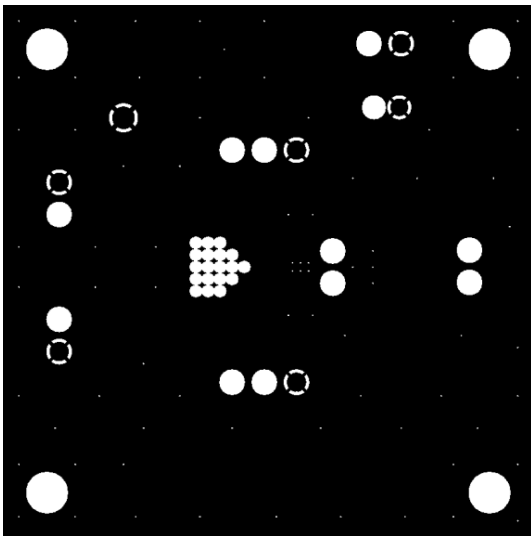

Figure 5. Second Layer Copper—GND Plane

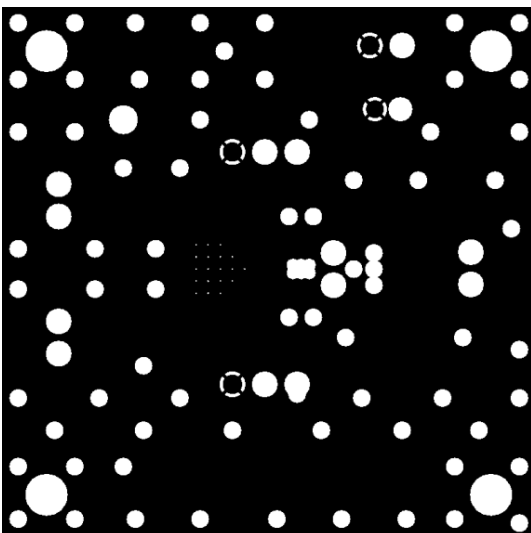
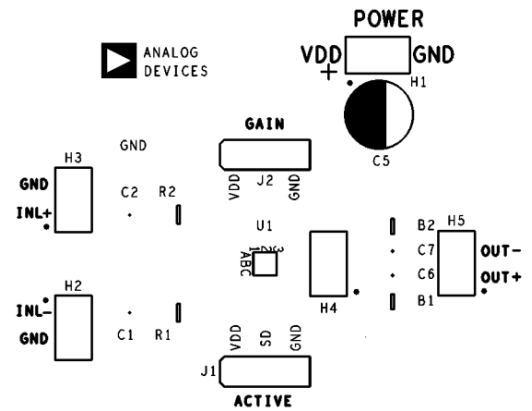

Figure 6. Third Layer Copper—VDD Plane



EVAL-SSM2377Z REV1.0  
Spec No: P-31055

Figure 8. Top Silkscreen

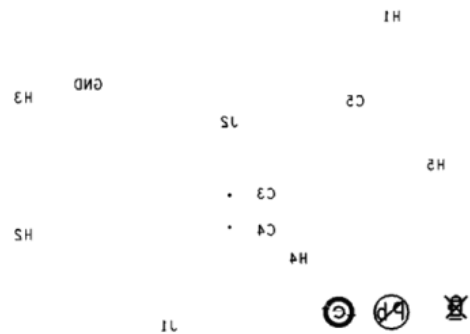

Figure 9. Bottom Silkscreen

## ORDERING INFORMATION

## BILL OF MATERIALS

Table 4.

Qty	Reference Designator	Description	Supplier	Part No.
1	U1	SSM2377 audio amplifier	Analog Devices	SSM2377ACBZ-RL
2	C1, C2	Capacitor, 22 nF, 50 V, $\pm 10\%$ , X7R, 0805	Panasonic	ECJ-2VB1H223K
1	C3	Capacitor, 0.1 $\mu$ F, 50 V, $-20\%/+80\%$ , Y5V, 0603	Panasonic	ECJ-1VF1H104Z
1	C4	Capacitor, 10 $\mu$ F, 10 V, $\pm 10\%$ , X5R, 0805	Taiyo Yuden	LMK212BJ106KG-T
1	C5	Capacitor, 47 $\mu$ F, 25 V, radial electrolytic, audio grade	Nichicon	UFW1E470MDD
2	C6, C7	Not installed	N/A	N/A
2	B1, B2	Wire short	N/A	N/A
2	R1, R2	Resistor, 0 $\Omega$ , 1/8 W, 5%, 0805	Panasonic	ERJ-6GEY0R00V
5	H1 to H5	Header, 2-position, 0.100", single, gold	Tyco	9-146285-0-02
2	J1, J2	Header, 3-position, 0.100", single, gold	Molex	22-28-4033

**ESD Caution**

**ESD (electrostatic discharge) sensitive device.** Charged devices and circuit boards can discharge without detection. Although this product features patented or proprietary protection circuitry, damage may occur on devices subjected to high energy ESD. Therefore, proper ESD precautions should be taken to avoid performance degradation or loss of functionality.

**Legal Terms and Conditions**

By using the evaluation board discussed herein (together with any tools, components documentation or support materials, the "Evaluation Board"), you are agreeing to be bound by the terms and conditions set forth below ("Agreement") unless you have purchased the Evaluation Board, in which case the Analog Devices Standard Terms and Conditions of Sale shall govern. Do not use the Evaluation Board until you have read and agreed to the Agreement. Your use of the Evaluation Board shall signify your acceptance of the Agreement. This Agreement is made by and between you ("Customer") and Analog Devices, Inc. ("ADI"), with its principal place of business at One Technology Way, Norwood, MA 02062, USA. Subject to the terms and conditions of the Agreement, ADI hereby grants to Customer a free, limited, personal, temporary, non-exclusive, non-sublicensable, non-transferable license to use the Evaluation Board FOR EVALUATION PURPOSES ONLY. Customer understands and agrees that the Evaluation Board is provided for the sole and exclusive purpose referenced above, and agrees not to use the Evaluation Board for any other purpose. Furthermore, the license granted is expressly made subject to the following additional limitations: Customer shall not (i) rent, lease, display, sell, transfer, assign, sublicense, or distribute the Evaluation Board; and (ii) permit any Third Party to access the Evaluation Board. As used herein, the term "Third Party" includes any entity other than ADI, Customer, their employees, affiliates and in-house consultants. The Evaluation Board is NOT sold to Customer; all rights not expressly granted herein, including ownership of the Evaluation Board, are reserved by ADI. CONFIDENTIALITY. This Agreement and the Evaluation Board shall all be considered the confidential and proprietary information of ADI. Customer may not disclose or transfer any portion of the Evaluation Board to any other party for any reason. Upon discontinuation of use of the Evaluation Board or termination of this Agreement, Customer agrees to promptly return the Evaluation Board to ADI. ADDITIONAL RESTRICTIONS. Customer may not disassemble, decompile or reverse engineer chips on the Evaluation Board. Customer shall inform ADI of any occurred damages or any modifications or alterations it makes to the Evaluation Board, including but not limited to soldering or any other activity that affects the material content of the Evaluation Board. Modifications to the Evaluation Board must comply with applicable law, including but not limited to the RoHS Directive. TERMINATION. ADI may terminate this Agreement at any time upon giving written notice to Customer. Customer agrees to return to ADI the Evaluation Board at that time. LIMITATION OF LIABILITY. THE EVALUATION BOARD PROVIDED HEREUNDER IS PROVIDED "AS IS" AND ADI MAKES NO WARRANTIES OR REPRESENTATIONS OF ANY KIND WITH RESPECT TO IT. ADI SPECIFICALLY DISCLAIMS ANY REPRESENTATIONS, ENDORSEMENTS, GUARANTEES, OR WARRANTIES, EXPRESS OR IMPLIED, RELATED TO THE EVALUATION BOARD INCLUDING, BUT NOT LIMITED TO, THE IMPLIED WARRANTY OF MERCHANTABILITY, TITLE, FITNESS FOR A PARTICULAR PURPOSE OR NON-INFRINGEMENT OF INTELLECTUAL PROPERTY RIGHTS. IN NO EVENT WILL ADI AND ITS LICENSORS BE LIABLE FOR ANY INCIDENTAL, SPECIAL, INDIRECT, OR CONSEQUENTIAL DAMAGES RESULTING FROM CUSTOMER'S POSSESSION OR USE OF THE EVALUATION BOARD, INCLUDING BUT NOT LIMITED TO LOST PROFITS, DELAY COSTS, LABOR COSTS OR LOSS OF GOODWILL. ADI'S TOTAL LIABILITY FROM ANY AND ALL CAUSES SHALL BE LIMITED TO THE AMOUNT OF ONE HUNDRED US DOLLARS (\$100.00). EXPORT. Customer agrees that it will not directly or indirectly export the Evaluation Board to another country, and that it will comply with all applicable United States federal laws and regulations relating to exports. GOVERNING LAW. This Agreement shall be governed by and construed in accordance with the substantive laws of the Commonwealth of Massachusetts (excluding conflict of law rules). Any legal action regarding this Agreement will be heard in the state or federal courts having jurisdiction in Suffolk County, Massachusetts, and Customer hereby submits to the personal jurisdiction and venue of such courts. The United Nations Convention on Contracts for the International Sale of Goods shall not apply to this Agreement and is expressly disclaimed.