

FEATURES

- **Ultralow Quiescent Current: 8.5µA Max**
- **Reference Output Drives 0.01µF Capacitor**
- **Adjustable Hysteresis (LTC1444/LTC1445)**
- **Wide Supply Range**
 - Single: 2V to 11V
 - Dual: ±1V to ±5.5V
- **Input Voltage Range Includes the Negative Supply**
- **TTL/CMOS Compatible Outputs**
- **Propagation Delay: 12µs (Typ) (10mV Overdrive)**
- **No Crowbar Current**
- **40mA Continuous Source Current**
- **Pin Compatible Upgrades for MAX924 (LTC1443)**
- **Low Profile (5mm × 4mm × 0.8mm) DFN Package**

APPLICATIONS

- **Battery-Powered System Monitoring**
- **Threshold Detectors**
- **Window Comparators**
- **Oscillator Circuits**

LT, LT, LTC, LTM, Linear Technology and the Linear logo are registered trademarks of Linear Technology Corporation. All other trademarks are the property of their respective owners.

DESCRIPTION

The LTC[®]1443/LTC1444/LTC1445 are ultralow power quad comparators with a built-in reference. The comparators feature less than 8.5µA supply current over temperature, an internal reference (1.182V ±1% for LTC1443 or 1.221V ±1% for LTC1444/LTC1445), programmable hysteresis (LTC1444/LTC1445) and TTL/CMOS output (LTC1443/LTC1445) that sinks and sources current (open-drain output for LTC1444). The reference output can drive a bypass capacitor of up to 0.01µF without oscillation.

The comparators operate from a single 2V to 11V supply or a dual ±1V to ±5.5V supply (LTC1443). Comparator hysteresis is easily programmable using two resistors and the HYST pin (LTC1444/LTC1445). Each comparator's input operates from the negative supply to within 1.3V of the positive supply. The LTC1443/LTC1445 comparator output stage can continuously source up to 40mA. By eliminating the cross-conducting current that normally happens when the comparator changes logic states, power supply glitches are eliminated.

The LTC1443/LTC1444/LTC1445 are available in the 16-pin SO, PDIP and DFN packages.

TYPICAL APPLICATION

Reference Settling Test Circuit

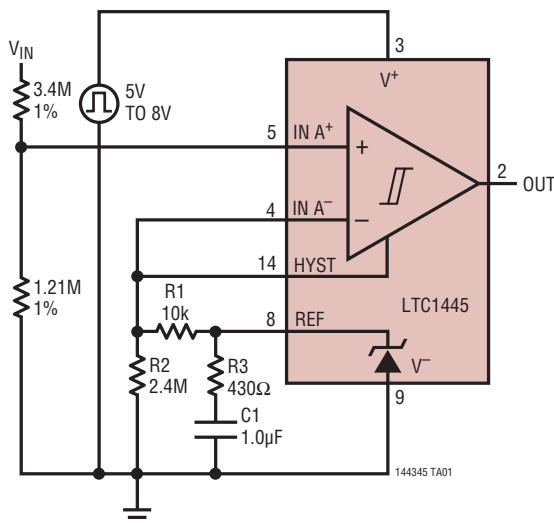

Reference Settling

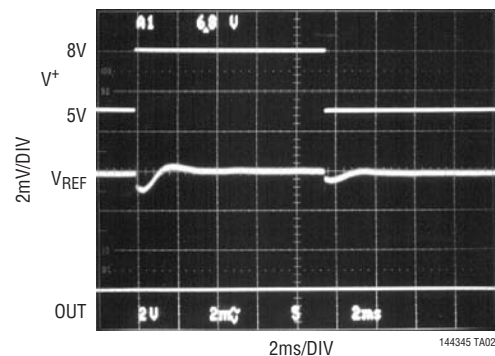

LTC1443/LTC1444/LTC1445

ABSOLUTE MAXIMUM RATINGS (Note 1)

Voltage:

V⁺ to V⁻, V⁺ to GND, GND to V⁻ 12V to -0.3V
 IN⁺, IN⁻, HYST (V⁺ + 0.3V) to (V⁻ - 0.3V)
 REF (V⁺ + 0.3V) to (V⁻ - 0.3V)
 OUT (LTC1443) (V⁺ + 0.3V) to (GND - 0.3V)
 OUT
 (LTC1444/LTC1445) (V⁺ + 0.3V) to (V⁻ - 0.3V)

Current:

IN⁺, IN⁻, HYST 20mA
 REF 20mA
 OUT 50mA

OUT Short-Circuit Duration (V⁺ ≤ 5.5V) Continuous
 Power Dissipation 500mW
 Operating Temperature Range
 Commercial 0°C to 70°C
 Industrial -40°C to 85°C
 Storage Temperature Range
 PDIP, SO -65°C to 150°C
 DFN -65°C to 125°C
 Lead Temperature Range (Soldering, 10 sec)
 PDIP, SO 300°C

PIN CONFIGURATION

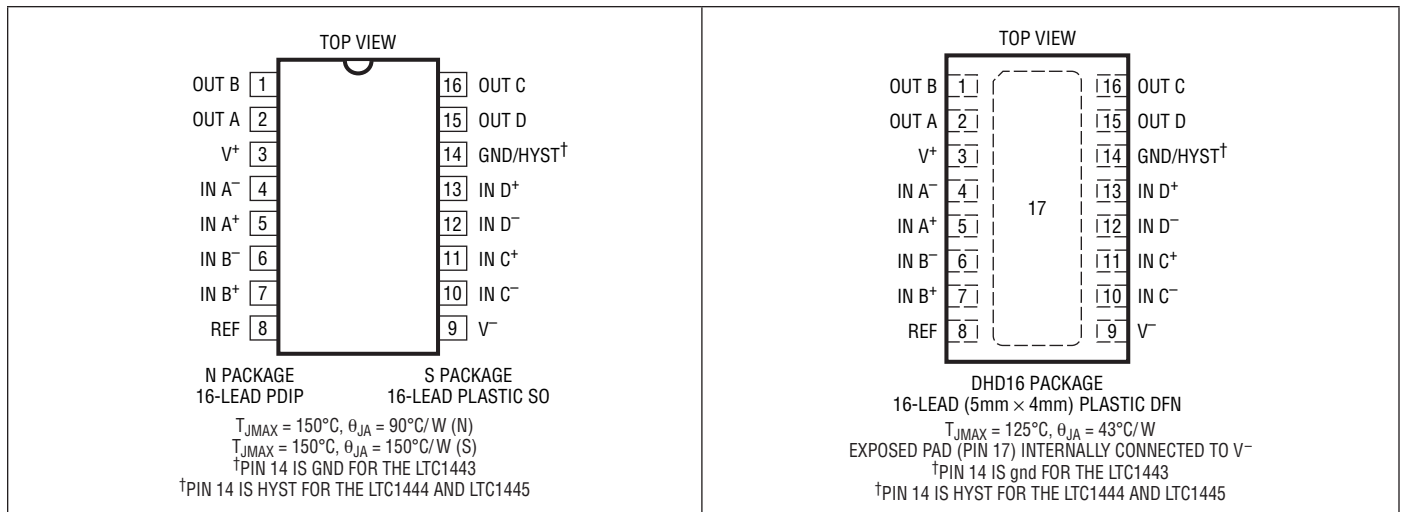

ORDER INFORMATION

LEAD FREE FINISH	TAPE AND REEL	PART MARKING*	PACKAGE DESCRIPTION	TEMPERATURE RANGE
LTC1443CN#PBF	LTC1443CN#TRPBF	LTC1443CN	16-Lead PDIP	0°C to 70°C
LTC1443CS#PBF	LTC1443CS#TRPBF	LTC1443CS	16-Lead Plastic SO	-40°C to 85°C
LTC1443IN#PBF	LTC1443IN#TRPBF	LTC1443IN	16-Lead PDIP	0°C to 70°C
LTC1443IS#PBF	LTC1443IS#TRPBF	LTC1443IS	16-Lead Plastic SO	-40°C to 85°C
LTC1444CN#PBF	LTC1444CN#TRPBF	LTC1444CN	16-Lead PDIP	0°C to 70°C
LTC1444CS#PBF	LTC1444CS#TRPBF	LTC1444CS	16-Lead Plastic SO	-40°C to 85°C
LTC1444IN#PBF	LTC1444IN#TRPBF	LTC1444IN	16-Lead PDIP	0°C to 70°C
LTC1444IS#PBF	LTC1444IS#TRPBF	LTC1444IS	16-Lead Plastic SO	-40°C to 85°C
LTC1445CN#PBF	LTC1445CN#TRPBF	LTC1445CN	16-Lead PDIP	0°C to 70°C
LTC1445CS#PBF	LTC1445CS#TRPBF	LTC1445CS	16-Lead Plastic SO	-40°C to 85°C
LTC1445IN#PBF	LTC1445IN#TRPBF	LTC1445IN	16-Lead PDIP	0°C to 70°C
LTC1445IS#PBF	LTC1445IS#TRPBF	LTC1445IS	16-Lead Plastic SO	-40°C to 85°C
LTC1443CDHD#PBF	LTC1443CDHD#TRPBF	1443	16-Lead (5mm × 4mm) Plastic DFN	0°C to 70°C
LTC1443IDHD#PBF	LTC1443IDHD#TRPBF	1443	16-Lead (5mm × 4mm) Plastic DFN	-40°C to 85°C
LTC1444CDHD#PBF	LTC1444CDHD#TRPBF	1444	16-Lead (5mm × 4mm) Plastic DFN	0°C to 70°C
LTC1444IDHD#PBF	LTC1444IDHD#TRPBF	1444	16-Lead (5mm × 4mm) Plastic DFN	-40°C to 85°C
LTC1445CDHD#PBF	LTC1445CDHD#TRPBF	1445	16-Lead (5mm × 4mm) Plastic DFN	0°C to 70°C
LTC1445IDHD#PBF	LTC1445IDHD#TRPBF	1445	16-Lead (5mm × 4mm) Plastic DFN	-40°C to 85°C
LEAD BASED FINISH	TAPE AND REEL	PART MARKING*	PACKAGE DESCRIPTION	TEMPERATURE RANGE
LTC1443CN	LTC1443CN#TR	LTC1443CN	16-Lead PDIP	0°C to 70°C
LTC1443CS	LTC1443CS#TR	LTC1443CS	16-Lead Plastic SO	-40°C to 85°C
LTC1443IN	LTC1443IN#TR	LTC1443IN	16-Lead PDIP	0°C to 70°C
LTC1443IS	LTC1443IS#TR	LTC1443IS	16-Lead Plastic SO	-40°C to 85°C
LTC1444CN	LTC1444CN#TR	LTC1444CN	16-Lead PDIP	0°C to 70°C
LTC1444CS	LTC1444CS#TR	LTC1444CS	16-Lead Plastic SO	-40°C to 85°C
LTC1444IN	LTC1444IN#TR	LTC1444IN	16-Lead PDIP	0°C to 70°C
LTC1444IS	LTC1444IS#TR	LTC1444IS	16-Lead Plastic SO	-40°C to 85°C
LTC1445CN	LTC1445CN#TR	LTC1445CN	16-Lead PDIP	0°C to 70°C
LTC1445CS	LTC1445CS#TR	LTC1445CS	16-Lead Plastic SO	-40°C to 85°C
LTC1445IN	LTC1445IN#TR	LTC1445IN	16-Lead PDIP	0°C to 70°C
LTC1445IS	LTC1445IS#TR	LTC1445IS	16-Lead Plastic SO	-40°C to 85°C
LTC1443CDHD	LTC1443CDHD#TR	1443	16-Lead (5mm × 4mm) Plastic DFN	0°C to 70°C
LTC1443IDHD	LTC1443IDHD#TR	1443	16-Lead (5mm × 4mm) Plastic DFN	-40°C to 85°C
LTC1444CDHD	LTC1444CDHD#TR	1444	16-Lead (5mm × 4mm) Plastic DFN	0°C to 70°C
LTC1444IDHD	LTC1444IDHD#TR	1444	16-Lead (5mm × 4mm) Plastic DFN	-40°C to 85°C
LTC1445CDHD	LTC1445CDHD#TR	1445	16-Lead (5mm × 4mm) Plastic DFN	0°C to 70°C
LTC1445IDHD	LTC1445IDHD#TR	1445	16-Lead (5mm × 4mm) Plastic DFN	-40°C to 85°C

Consult LTC Marketing for parts specified with wider operating temperature ranges. *The temperature grade is identified by a label on the shipping container.

For more information on lead free part marking, go to: <http://www.linear.com/leadfree/>

For more information on tape and reel specifications, go to: <http://www.linear.com/tapeandree/>

LTC1443/LTC1444/LTC1445

ELECTRICAL CHARACTERISTICS The ● denotes the specifications which apply over the full operating temperature range, otherwise specifications are at $T_A = 25^\circ\text{C}$. $V^+ = 5\text{V}$, $V^- = \text{GND} = 0\text{V}$, unless otherwise noted.

SYMBOL	PARAMETER	CONDITIONS	MIN	TYP	MAX	UNITS		
Power Supply								
V^+	Supply Voltage Range		●	2.0	11.0	V		
I_{CC}	Supply Current	$I_{\text{N}^+} = I_{\text{N}^-} = 80\text{mV}$ HYST = REF (LTC1444/LTC1445)	●	5.5	8.5	μA		
Comparator								
V_{OS}	Comparator Input Offset Voltage	$V_{\text{CM}} = 2.5\text{V}$	●	± 3.0	± 10.0	mV		
I_{IN}	Input Leakage Current (I_{N^+} , I_{N^-})	$V_{\text{IN}^+} = V_{\text{IN}^-} = 2.5\text{V}$	●	± 0.01	± 1.0	nA		
	Input Leakage Current (HYST)	LTC1444/LTC1445	●	± 0.02	± 1.0	nA		
V_{CM}	Comparator Input Common Mode Range		●	V^-	$V^+ - 1.3\text{V}$	V		
CMRR	Common Mode Rejection Ratio	V^- to $(V^+ - 1.3\text{V})$		0.1	1.0	mV/V		
PSRR	Power Supply Rejection Ratio	$V^+ = 2\text{V}$ to 11V		0.1	1.0	mV/V		
Noise	Voltage Noise	100Hz to 100kHz		20		μV_{RMS}		
V_{HYST}	Hysteresis Input Voltage Range	LTC1444, LTC1445	●	REF - 50mV	REF	V		
t_{PD}	Propagation Delay	Overdrive = 10mV, $C_{\text{OUT}} = 100\text{pF}$ Overdrive = 100mV, $C_{\text{OUT}} = 100\text{pF}$		12 4		μs μs		
V_{OH}	Output High Voltage	$I_{\text{O}} = -15\text{mA}$; LTC1443/LTC1445	●	$V^+ - 0.4\text{V}$		V		
V_{OL}	Output Low Voltage	$I_{\text{O}} = 1.8\text{mA}$; LTC1443	●		GND + 0.4V	V		
		$I_{\text{O}} = 1.8\text{mA}$; LTC1444/LTC1445	●		$V^- + 0.4\text{V}$	V		
Reference								
V_{REF}	Reference Voltage	No Load, LTC1443	C Temp Range	●	1.170	1.182	1.194	V
			I Temp Range	●	1.164		1.200	V
		No Load, LTC1444/ LTC1445	C Temp Range	●	1.209	1.221	1.233	V
			I Temp Range	●	1.203		1.239	V
I_{SOURCE}	Reference Output Source Current	$\Delta V_{\text{REF}} \leq 1\text{mV}$	●	100	200	μA		
I_{SINK}	Reference Output Sink Current	$\Delta V_{\text{REF}} \leq 2.5\text{mV}$		10	15	μA		
		$\Delta V_{\text{REF}} \leq 5\text{mV}$	●	10	15	μA		
Noise	Voltage Noise	100Hz to 100kHz		100		μV_{RMS}		

The ● denotes the specifications which apply over the full operating temperature range, otherwise specifications are at $T_A = 25^\circ\text{C}$. $V^+ = 3\text{V}$, $V^- = \text{GND} = 0\text{V}$, unless otherwise noted.

SYMBOL	PARAMETER	CONDITIONS	MIN	TYP	MAX	UNITS
Power Supply						
V^+	Supply Voltage Range		●	2.0	11.0	V
I_{CC}	Supply Current	$I_{\text{N}^+} = I_{\text{N}^-} = 80\text{mV}$, HYST = REF	●	5	8	μA
Comparator						
V_{OS}	Comparator Input Offset Voltage	$V_{\text{CM}} = 1.5\text{V}$	●	± 3.0	± 10.0	mV
I_{IN}	Input Leakage Current (I_{N^+} , I_{N^-})	$V_{\text{IN}^+} = V_{\text{IN}^-} = 1.5\text{V}$	●	± 0.01	± 1.0	nA
	Input Leakage Current (HYST)	LTC1444/LTC1445	●	± 0.02	± 1.0	nA
V_{CM}	Comparator Input Common Mode Range		●	V^-	$V^+ - 1.3\text{V}$	V
CMRR	Common Mode Rejection Ratio	V^- to $(V^+ - 1.3\text{V})$		0.1	1.0	mV/V
PSRR	Power Supply Rejection Ratio	$V^+ = 2\text{V}$ to 11V		0.1	1.0	mV/V
Noise	Voltage Noise	100Hz to 100kHz		100		μV_{RMS}
V_{HYST}	Hysteresis Input Voltage Range	LTC1444, LTC1445	●	REF - 50mV	REF	V
t_{PD}	Propagation Delay	Overdrive = 10mV, $C_{\text{OUT}} = 100\text{pF}$ Overdrive = 100mV, $C_{\text{OUT}} = 100\text{pF}$		14 5		μs μs
V_{OH}	Output High Voltage	$I_{\text{O}} = -10\text{mA}$; LTC1443/LTC1445	●	$V^+ - 0.4\text{V}$		V
V_{OL}	Output Low Voltage	$I_{\text{O}} = 0.8\text{mA}$; LTC1443	●		GND + 0.4V	V
		$I_{\text{O}} = 0.8\text{mA}$; LTC1444/LTC1445	●		$V^- + 0.4\text{V}$	V

144345fd

ELECTRICAL CHARACTERISTICS

The ● denotes the specifications which apply over the full operating temperature range, otherwise specifications are at $T_A = 25^\circ\text{C}$. $V^+ = 3\text{V}$, $V^- = \text{GND} = 0\text{V}$, unless otherwise noted.

SYMBOL	PARAMETER	CONDITIONS	MIN	TYP	MAX	UNITS	
Reference							
V_{REF}	Reference Voltage	No Load, LTC1443	C Temp Range ●	1.170	1.182	1.194	V
			I Temp Range ●	1.164		1.200	V
		No Load, LTC1444/ LTC1445	C Temp Range ●	1.209	1.221	1.233	V
			I Temp Range ●	1.203		1.239	V
I_{SOURCE}	Reference Output Source Current	$\Delta V_{\text{REF}} \leq 1\text{mV}$	●	60	120	μA	
I_{SINK}	Reference Output Sink Current	$\Delta V_{\text{REF}} \leq 2.5\text{mV}$	●	10	15	μA	
		$\Delta V_{\text{REF}} \leq 5\text{mV}$	●	10	15	μA	
Noise	Noise Voltage	100Hz to 100kHz			100	μV_{RMS}	

Note 1: Stresses beyond those listed under Absolute Maximum Ratings may cause permanent damage to the device. Exposure to any Absolute Maximum Rating condition for extended periods may affect device reliability and lifetime.

TYPICAL PERFORMANCE CHARACTERISTICS

**LTC1444/LTC1445
Hysteresis Control**

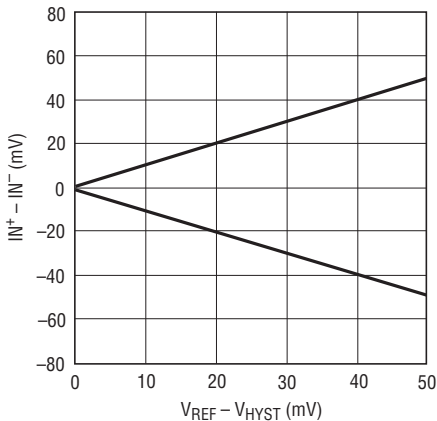

144345 G01

Supply Current vs Supply Voltage

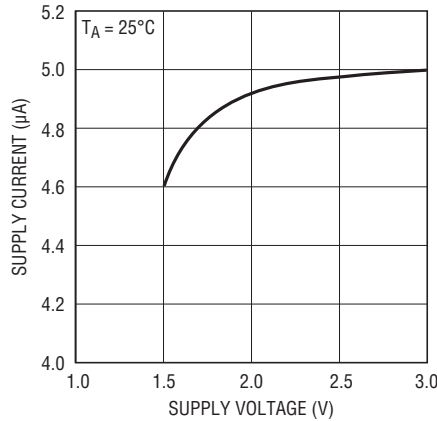

144345 G02

Supply Current vs Temperature

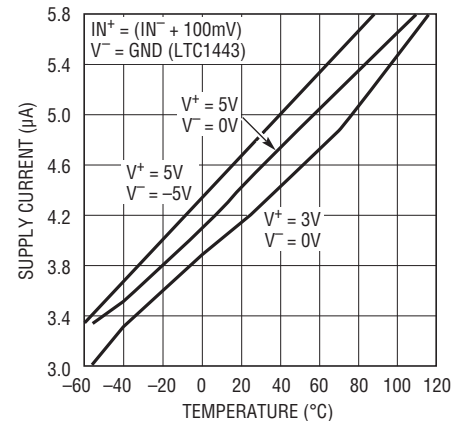

144345 G03

**LTC1444/LTC1445 Reference
Voltage vs Temperature**

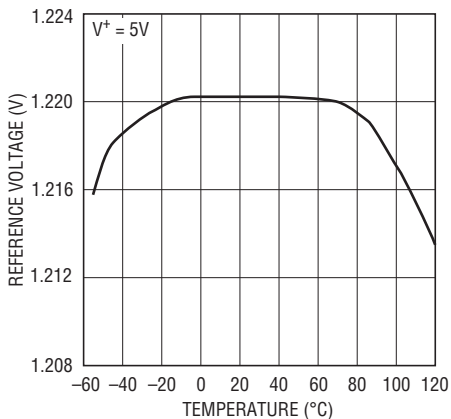

144345 G04

**LTC1443 Reference Voltage
vs Temperature**

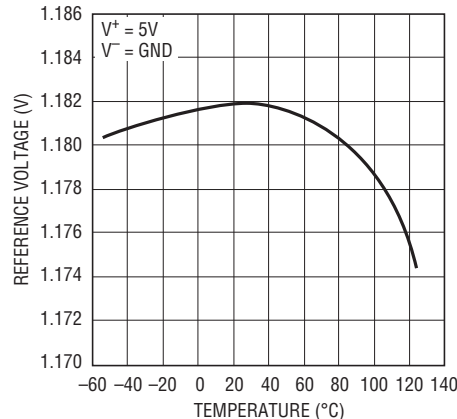

144345 G05

**LTC1443 Reference Output
Voltage vs Output Load Current**

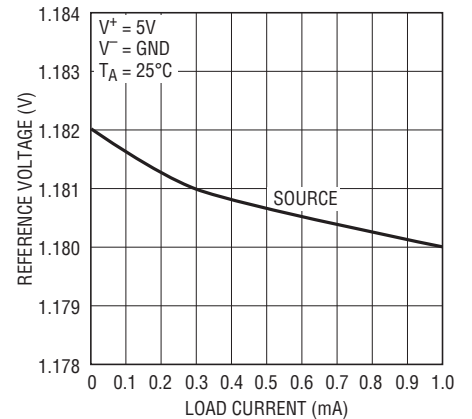

144345 G06
144345fd

TYPICAL PERFORMANCE CHARACTERISTICS

LTC1443 Reference Output Voltage vs Output Load Current

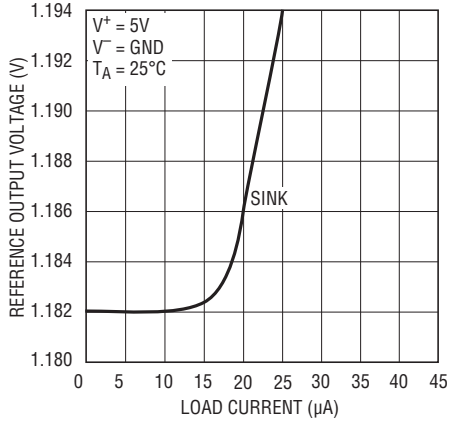

144345 G07

Comparator Output Voltage High vs Load Current

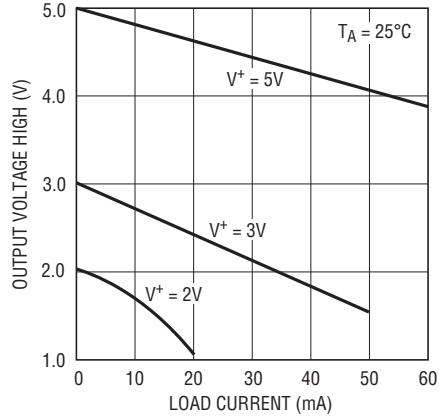

144345 G08

Comparator Output Voltage Low vs Load Current

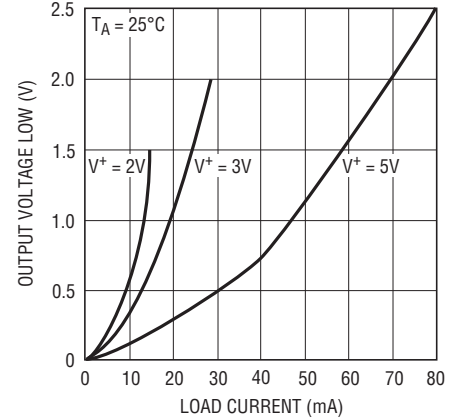

144345 G09

Comparator Response Time vs Input Overdrive

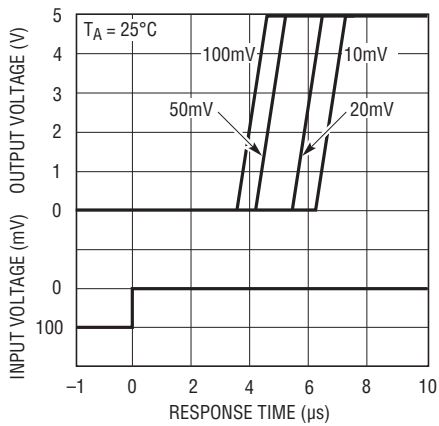

144345 G10

Comparator Response Time vs Input Overdrive

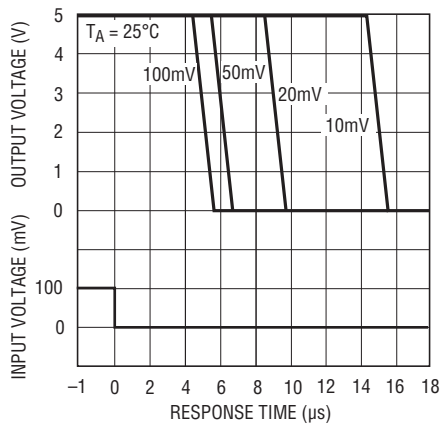

144345 G11

Comparator Short-Circuit Sink Current vs Supply Voltage

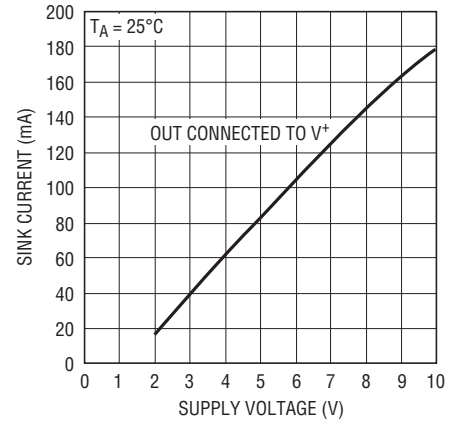

144345 G12

Comparator Short-Circuit Source Current vs Supply Voltage

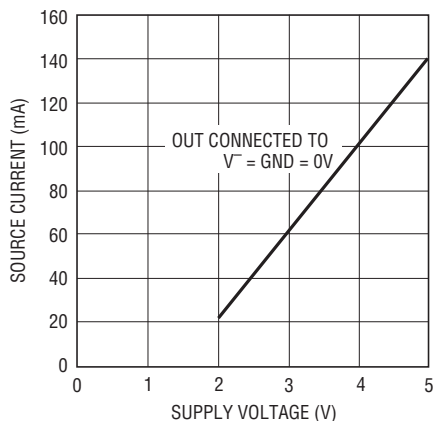

144345 G13

Comparator Response Time vs Load Capacitance

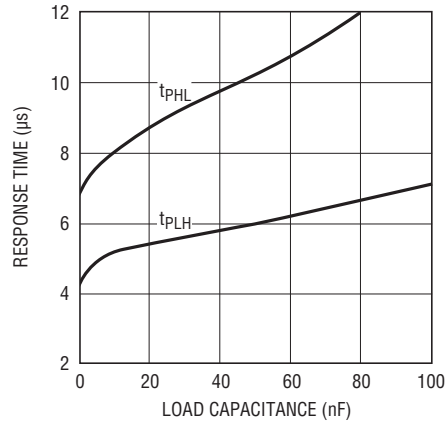

144345 G14

TYPICAL PERFORMANCE CHARACTERISTICS

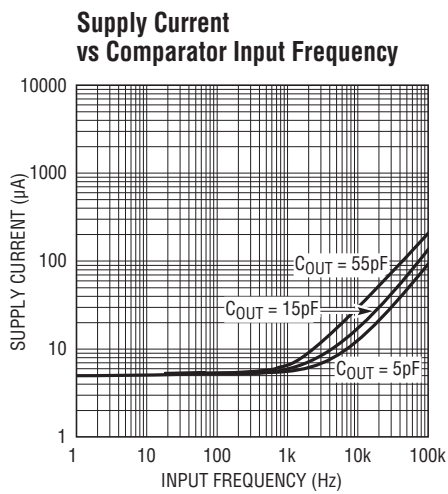

144345 G15

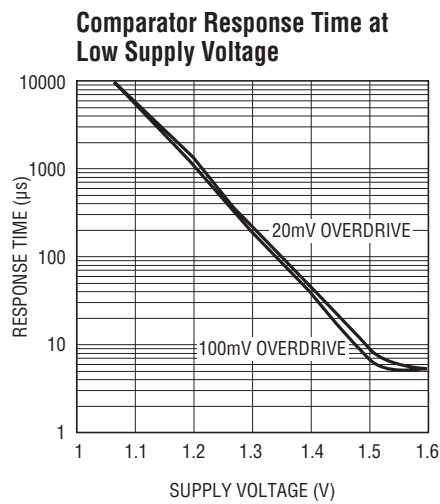

144345 G16

PIN FUNCTIONS

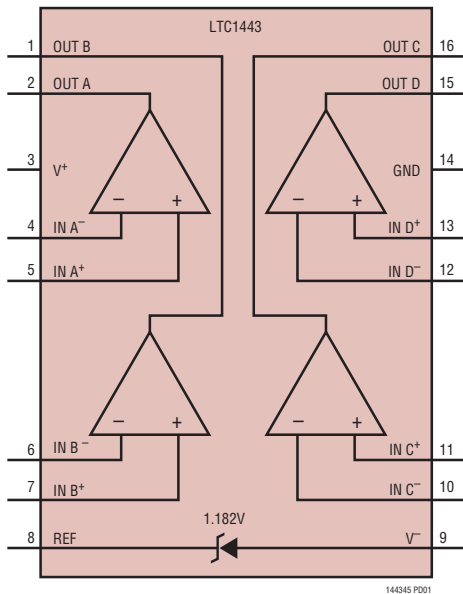

144345 PD01

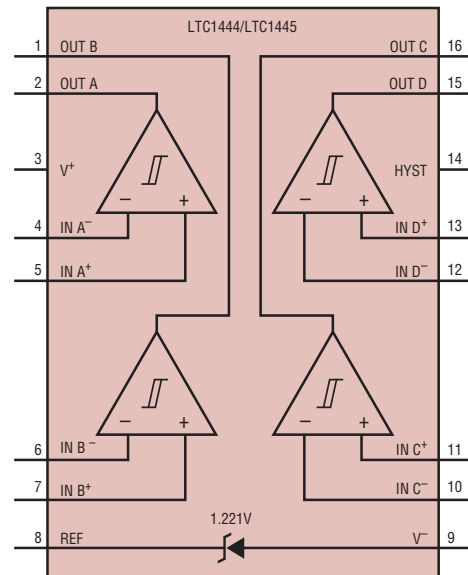

144345 PD02

OUT B (Pin 1): Comparator B Output. (Open-drain output for LTC1444). Output can source up to 40mA (LTC1443, LTC1445) and sink 5mA.

OUT A (Pin 2): Comparator A Output. (Open-drain output for LTC1444). Output can source up to 40mA (LTC1443, LTC1445) and sink 5mA.

V+ (Pin 3): Positive Supply.

IN A- (Pin 4): Inverting Input of Comparator A. Input common mode range from V^- to $V^+ - 1.3V$. Input current typically 10pA at 25°C.

IN A+ (Pin 5): Noninverting Input of Comparator A. Input common mode range from V^- to $V^+ - 1.3V$. Input current typically 10pA at 25°C.

IN B- (Pin 6): Inverting Input of Comparator B. Input common mode range from V^- to $V^+ - 1.3V$. Input current typically 10pA at 25°C.

PIN FUNCTIONS

IN B⁺ (Pin 7): Noninverting Input of Comparator B. Input common mode range from V^- to $V^+ - 1.3V$. Input current typically 10pA at 25°C.

REF (Pin 8): Reference Output. With respect to V^- . Can source up to 200 μ A and sink 15 μ A at 25°C. Drive 0.01 μ F bypass capacitor without oscillation.

V⁻ (Pin 9): Negative Supply. Connect to ground for single supply operation on LTC1443.

IN C⁻ (Pin 10): Inverting Input of Comparator C. Input common mode range from V^- to $V^+ - 1.3V$. Input current typically 10pA at 25°C.

IN C⁺ (Pin 11): Noninverting Input of Comparator C. Input common mode range from V^- to $V^+ - 1.3V$. Input current typically 10pA at 25°C.

IN D⁻ (Pin 12): Inverting Input of Comparator D. Input common mode range from V^- to $V^+ - 1.3V$. Input current typically 10pA at 25°C.

IN D⁺ (Pin 13): Noninverting Input of Comparator D. Input common mode range from V^- to $V^+ - 1.3V$. Input current typically 10pA at 25°C.

GND (Pin 14): LTC1443 Ground. Connect to V^- for single supply operation.

HYST (Pin 14): LTC1444/LTC1445 Hysteresis Input. Connect to REF if not used. Input voltage range is from V_{REF} to $V_{REF} - 50mV$.

OUT D (Pin 15): Comparator D Output. (Open-drain output for LTC1444). Output can source up to 40mA (LTC1443, LTC1445) and sink 5mA.

OUT C (Pin 16): Comparator C Output. (Open-drain output for LTC1444). Output can source up to 40mA (LTC1443, LTC1445) and sink 5mA.

Exposed Pad (Pin 17, DFN Package): This pin is internally connected to V^- . Connection is optional, but will improve thermal dissipation.

APPLICATIONS INFORMATION

The LTC1443/LTC1444/LTC1445 is a family of quad micropower comparators with a built-in reference (1.182V for the LTC1443 and 1.221V for the LTC1444/LTC1445). Features include programmable hysteresis (LTC1444/LTC1445), wide supply voltage range (2V to 11V) and the ability of the reference to drive up to a 0.01 μ F capacitor without oscillation. The comparator CMOS outputs (LTC1443/LTC1445) can source up to 40mA while the LTC1444 has an open-drain output to V^- . The supply current glitches that normally occur when the comparator output switches states have been eliminated.

Power Supplies

The comparator family operates from a single 2V to 11V supply. The LTC1443 includes a separate ground for the comparator output stage, allowing a split supply ranging from $\pm 1V$ to $\pm 5.5V$. Connecting V^- to GND on the LTC1443 allows single supply operation. If the comparator output is required to source more than 1mA or the supply source impedance is high, V^+ should be bypassed with a 0.1 μ F capacitor.

Comparator Inputs

The comparator inputs can swing from the negative supply (V^-) to within 1.3V maximum of the positive supply (V^+). The inputs can be forced 300mV below V^- or above V^+ without damage, and the typical input leakage current is only $\pm 10pA$.

Comparator Outputs

The LTC1443 comparator output swings between GND and V^+ to assure TTL compatibility with a split supply. The LTC1444 and LTC1445 outputs swing between V^- and V^+ . The outputs are capable of sourcing up to 40mA (LTC1443/LTC1445) and sinking up to 5mA while still maintaining microampere quiescent currents. The output stage does not generate crowbar switching currents during transitions which helps minimize parasitic feedback through the supply pins.

Voltage Reference

The internal bandgap reference has a voltage of 1.182V for LTC1443 or 1.221V for LTC1444/LTC1445 referenced to

144345fd

APPLICATIONS INFORMATION

V^- . The reference accuracy is 1.5% from -40°C to 85°C . It can source up to $200\mu\text{A}$ and sink up to $15\mu\text{A}$ with a 5V supply. The reference can drive a bypass capacitor of up to $0.01\mu\text{F}$ without oscillation and by inserting a series resistor, capacitance values up to $100\mu\text{F}$ can be used (Figure 1).

Figure 2 shows the resistor value required for different capacitor values to achieve critical damping.

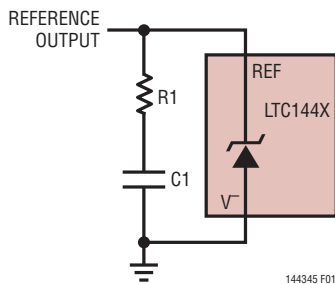

Figure 1. Damping the Reference Output

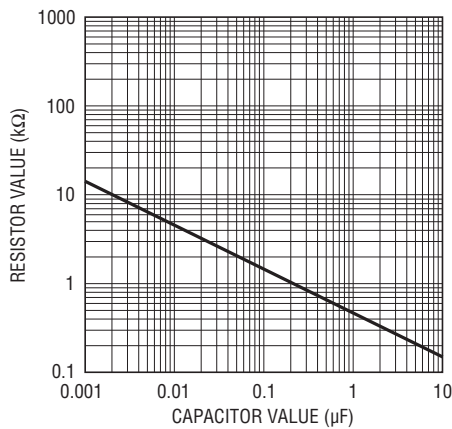

Figure 2. Damping Resistance vs Bypass Capacitor Value

Bypassing the reference can help prevent false tripping of the comparators by preventing glitches on the V^+ or the reference output voltage. Figure 3 shows the bypassed reference output with a square wave applied to the V^+ pin. Resistors R1 and R2 set 10mV of hysteresis, while R3 damps the reference response. Note that the comparator output doesn't trip.

Hysteresis

Hysteresis can be added to the LTC1444/LTC1445 by connecting a resistor (R1) between the REF and HYST pins, and a second resistor (R2) from HYST to V^- (Figure 4).

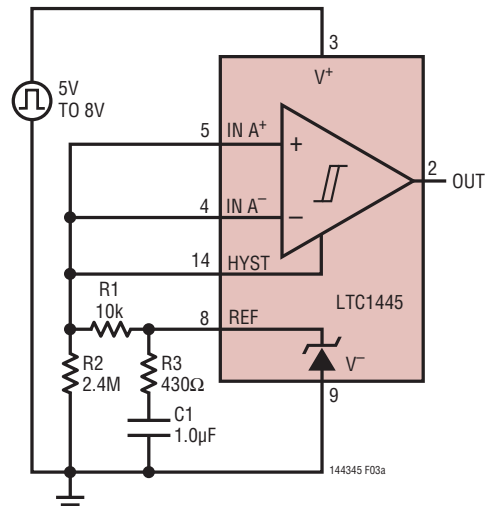

Figure 3a. V^+ Glitching Test Circuit

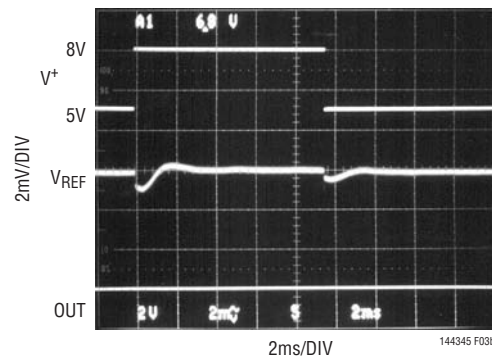

Figure 3b. V^+ Glitching Response

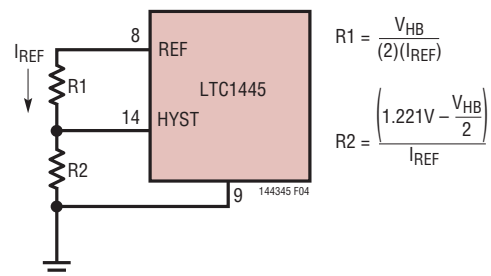

Figure 4. Programmable Hysteresis

The difference between the upper and lower threshold voltages or hysteresis voltage band (V_{HB}) is equal to twice the voltage difference between the REF and HYST pins. When more hysteresis is added, the upper threshold increases the same amount as the lower threshold decreases. The maximum voltage allowed between REF and HYST is

APPLICATIONS INFORMATION

50mV, producing a maximum hysteresis voltage band of 100mV. If hysteresis is not wanted, the HYST pin should be shorted to REF. Acceptable values for I_{REF} range from 0.1 μ A to 5 μ A. If 2.4M is chosen for R2, then $R1(k\Omega) = V_{HB} (mV)$.

Level Detector

The LTC1444 is ideal for use as a multisupply micropower level detector as shown in Figure 5.

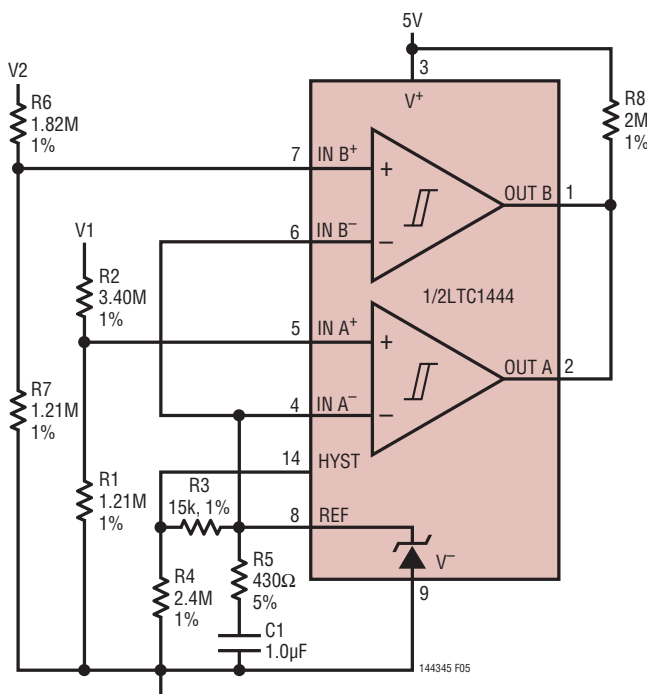

Figure 5. Glitch-Free Level Detector with Hysteresis

R1 and R2 form a voltage divider from V1 to the noninverting comparator A input. R6 and R7 are used to divide down V2, while R8 is the output pull-up resistor for the comparator outputs. R3 and R4 set the hysteresis voltage and R5 and C1 bypass the reference output. The following design procedure can be used to select the component values:

1. Choose the V1 voltage trip level, in this example 4.65V.
2. Calculate the required resistive divider ratio.

$$\text{Ratio} = V_{REF}/V_{IN}$$

$$\text{Ratio} = 1.221V/4.65V = 0.263$$

3. Choose the required hysteresis voltage band at the input, V_{HBIN} , in this example 60mV. Calculate the hysteresis voltage band referred to the comparator input V_{HB} .

$$V_{HB} = (V_{HBIN})(\text{Ratio})$$

$$V_{HB} = (60mV)(0.263)$$

$$V_{HB} = 15.78mV$$

4. Choose the values for R3 and R4 to set the hysteresis.

$$R4 = 2.4M$$

$$R3(k\Omega) = V_{HB} = 15k$$

5. Choose the values for R1 and R2 to set the trip point.

$$R1 = V_{REF}/I_{BIAS} = 1.221V/1\mu A \approx 1.21M$$

$$R2 = (R1) \left[\frac{V_{IN}}{V_{REF} + \frac{V_{HB}}{2}} - 1 \right]$$

$$R2 = (1.21M) \left[\frac{4.65V}{1.221V + \frac{15mV}{2}} - 1 \right]$$

$$R2 = 3.40M$$

Using the same equations, R6 and R7 are 1.82M and 1.21M respectively to set the trip level at 3V for V2.

PACKAGE DESCRIPTION

N Package
16-Lead PDIP (Narrow .300 Inch)
 (Reference LTC DWG # 05-08-1510)

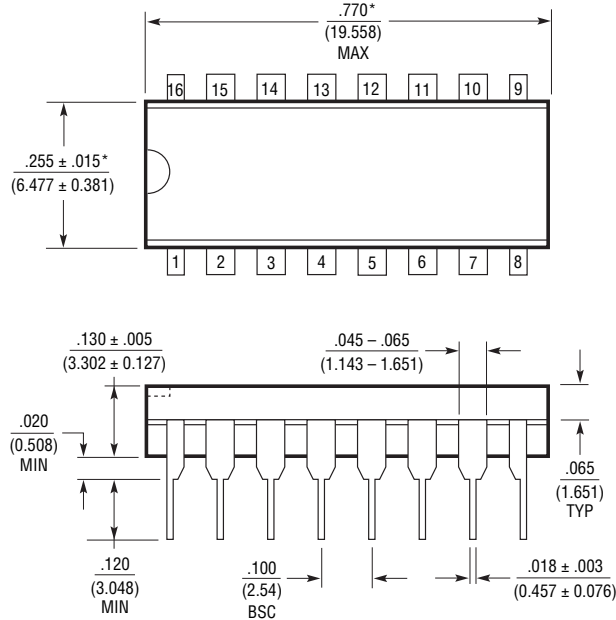

NOTE:
 1. DIMENSIONS ARE $\frac{\text{INCHES}}{\text{MILLIMETERS}}$
 *THESE DIMENSIONS DO NOT INCLUDE MOLD FLASH OR PROTRUSIONS.
 MOLD FLASH OR PROTRUSIONS SHALL NOT EXCEED .010 INCH (0.254mm)

N16 1002

S Package
16-Lead Plastic Small Outline (Narrow .150 Inch)
 (Reference LTC DWG # 05-08-1610)

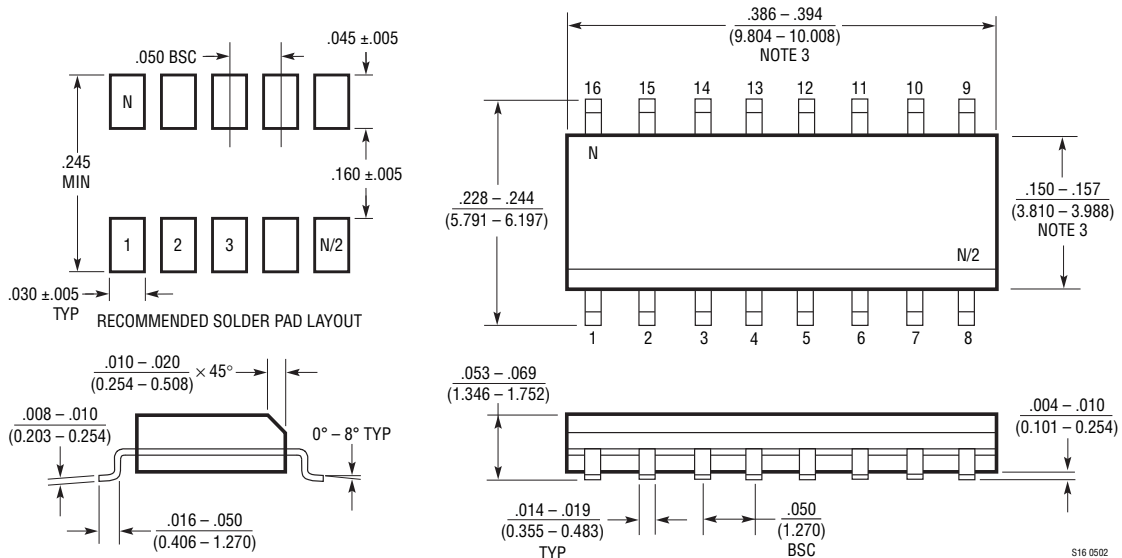

NOTE:
 1. DIMENSIONS IN $\frac{\text{INCHES}}{\text{MILLIMETERS}}$
 2. DRAWING NOT TO SCALE
 3. THESE DIMENSIONS DO NOT INCLUDE MOLD FLASH OR PROTRUSIONS.
 MOLD FLASH OR PROTRUSIONS SHALL NOT EXCEED .006" (0.15mm)

S16 0502

PACKAGE DESCRIPTION

DHD Package
16-Lead Plastic DFN (5mm × 4mm)
 (Reference LTC DWG # 05-08-1707)

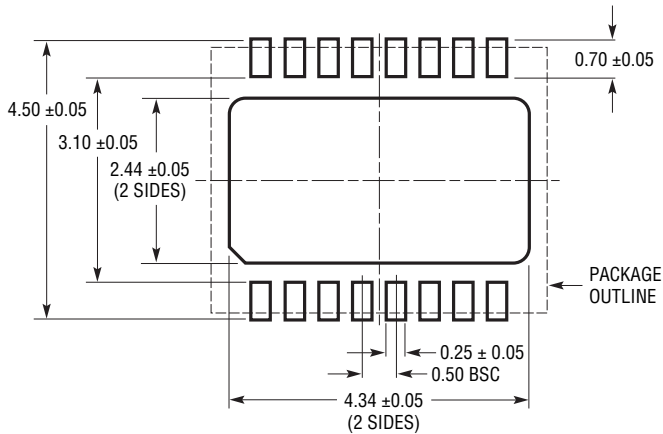

RECOMMENDED SOLDER PAD PITCH AND DIMENSIONS

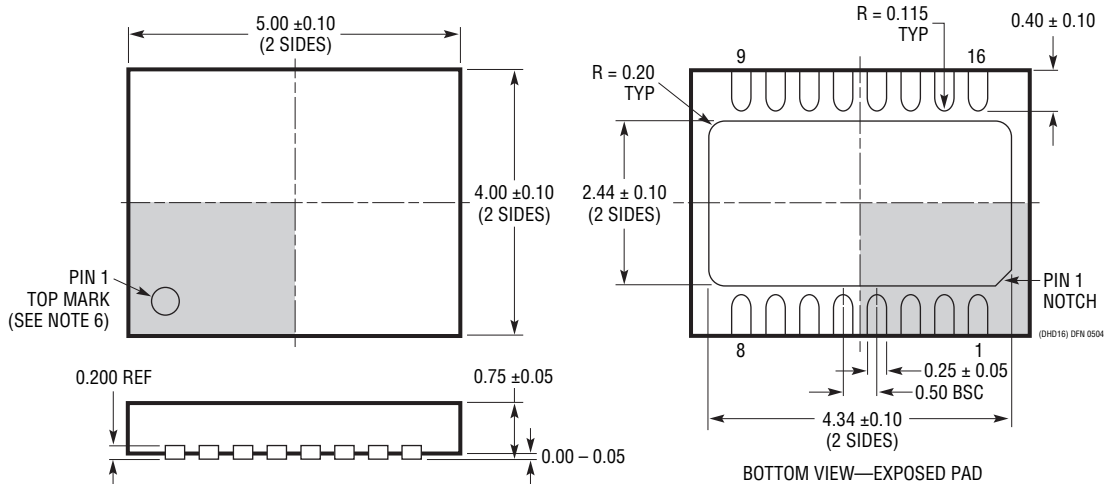

NOTE:

1. DRAWING PROPOSED TO BE MADE VARIATION OF VERSION (WJGD-2) IN JEDEC PACKAGE OUTLINE MO-229
2. DRAWING NOT TO SCALE
3. ALL DIMENSIONS ARE IN MILLIMETERS
4. DIMENSIONS OF EXPOSED PAD ON BOTTOM OF PACKAGE DO NOT INCLUDE MOLD FLASH. MOLD FLASH, IF PRESENT, SHALL NOT EXCEED 0.15mm ON ANY SIDE
5. EXPOSED PAD SHALL BE SOLDER PLATED
6. SHADED AREA IS ONLY A REFERENCE FOR PIN 1 LOCATION ON THE TOP AND BOTTOM OF PACKAGE

REVISION HISTORY (Revision history begins at Rev D)

REV	DATE	DESCRIPTION	PAGE NUMBER
D	4/11	Minor update to Figure 5 in the Applications Information section.	10

LTC1443/LTC1444/LTC1445

TYPICAL APPLICATION

Single Cell to 5V Supply

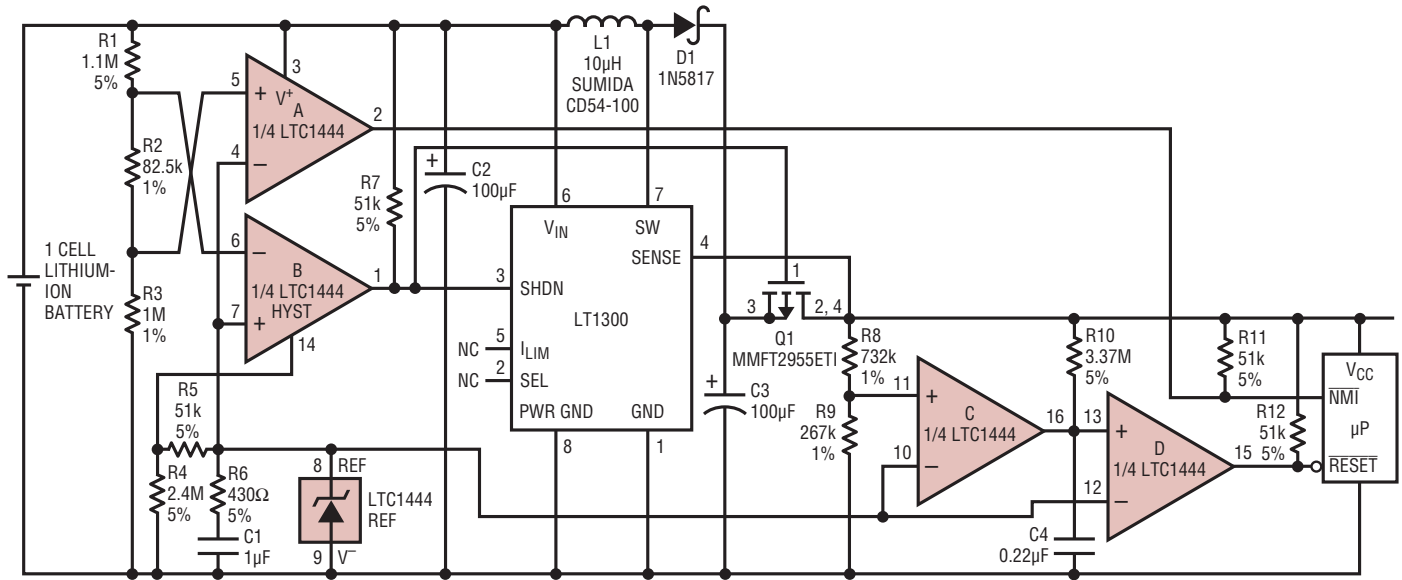

C2, C3: AUX TPSD107M010R0100 OR
SANYO OS-CON 16SA100M

144345 TA03

RELATED PARTS

PART NUMBER	DESCRIPTION	COMMENTS
LTC1041	Bang-Bang Controller with 1nA Off Current	2.8V to 18V, Ideal for Temperature or Motor Control Circuit
LTC1042	Micropower, High Accuracy Window Comparator	Fault Detect, Go/No Go Test, Supply Monitor
LTC1440/LTC1540	Ultralow Power Comparator with Reference	1.128V \pm 1% Reference, \pm 10mV (Max) Input Offset
LTC1441/LTC1442	Dual Ultralow Power Comparators with Reference	1.182V \pm 1% Reference, 8 μ s Prop Delay, 5.7 μ A
LTC1541/LTC1542	Combined Amplifier, Comparator and Reference	1.2V \pm 0.8 Reference, Amplifier Stable with 1000pF Load
LTC1842/LTC1843	Dual Ultralow Power Comparators with Reference	1.182V \pm 1% Reference, 4 μ s, 3.5 μ A, Open-Drain Out
LTC1921	Dual Independent Monitors for -48V Supply and Fuse	-48V Telecom and Network Backplane Monitor
LTC1998	High Accuracy Comparator with 1.2V Reference	Adjustable Threshold and Hysteresis, 2.5mA Supply
LT [®] 6700-1/LT6700-2 LT6700-3	Dual Comparators with 400mV Reference	1.4V to 18V Operating Range, 18 μ s Prop Delay, Available in SOT-23 and 2mm \times 3mm DFN Packages

144345fd