



Chip beads

For general signal line

MMZ series (for automotive)

MMZ1608_{type}

MMZ1608

1608[0603 inch]*

* Dimensions code JIS[EIA]

REMINDERS FOR USING THESE PRODUCTS

Before using these products, be sure to request the delivery specifications.

SAFETY REMINDERS

Please pay sufficient attention to the warnings for safe designing when using this products.

REMINDERS

- The storage period is less than 12 months. Be sure to follow the storage conditions (temperature: 5 to 40°C, humidity: 10 to 75% RH or less).
If the storage period elapses, the soldering of the terminal electrodes may deteriorate.
- Do not use or store in locations where there are conditions such as gas corrosion (salt, acid, alkali, etc.).
- Before soldering, be sure to preheat components.
The preheating temperature should be set so that the temperature difference between the solder temperature and chip temperature does not exceed 150°C.
- Soldering corrections after mounting should be within the range of the conditions determined in the specifications.
If overheated, a short circuit, performance deterioration, or lifespan shortening may occur.
- When embedding a printed circuit board where a chip is mounted to a set, be sure that residual stress is not given to the chip due to the overall distortion of the printed circuit board and partial distortion such as at screw tightening portions.
- Self heating (temperature increase) occurs when the power is turned ON, so the tolerance should be sufficient for the set thermal design.
- Carefully lay out the coil for the circuit board design of the non-magnetic shield type.
A malfunction may occur due to magnetic interference.
- Use a wrist band to discharge static electricity in your body through the grounding wire.
- Do not expose the products to magnets or magnetic fields.
- Do not use for a purpose outside of the contents regulated in the delivery specifications.
- The products listed on this catalog are intended for use in general electronic equipment (AV equipment, telecommunications equipment, home appliances, amusement equipment, computer equipment, personal equipment, office equipment, measurement equipment, industrial robots) under a normal operation and use condition.
The products are not designed or warranted to meet the requirements of the applications listed below, whose performance and/or quality require a more stringent level of safety or reliability, or whose failure, malfunction or trouble could cause serious damage to society, person or property.
If you intend to use the products in the applications listed below or if you have special requirements exceeding the range or conditions set forth in the each catalog, please contact us.

- (1) Aerospace/aviation equipment
- (2) Transportation equipment (electric trains, ships, etc.)
- (3) Medical equipment
- (4) Power-generation control equipment
- (5) Atomic energy-related equipment
- (6) Seabed equipment
- (7) Transportation control equipment

- (8) Public information-processing equipment
- (9) Military equipment
- (10) Electric heating apparatus, burning equipment
- (11) Disaster prevention/crime prevention equipment
- (12) Safety equipment
- (13) Other applications that are not considered general-purpose applications

When designing your equipment even for general-purpose applications, you are kindly requested to take into consideration securing protection circuit/device or providing backup circuits in your equipment.

Chip beads

For general signal line

Product compatible with RoHS directive
 Halogen-free
 Compatible with lead-free solders
 AEC-Q200

Overview of MMZ1608 type

FEATURES

- Noise reduction solution for general signal line.
- Various frequency characteristics with 8 materials of different features for countermeasures against everything from general signals to high-speed signals.

APPLICATION

Various ECUs, powertrains, body controls, and car multimedia (telematics).

PART NUMBER CONSTRUCTION

MMZ	1608	B	121	C	T	DH5	
Series name	LxWxT dimensions (mm)		Impedance (Ω) at 100MHz		Characteristic type	Packaging style	Internal code
	1608	1.6x0.8x0.6	121	120	C	T	D25
		1.6x0.8x0.8			A	Taping	DH5
					B		

OPERATING TEMPERATURE RANGE, PACKAGE QUANTITY, PRODUCT WEIGHT

Type	Temperature ranges		Package quantity (pieces/reel)	Individual weight (mg)
	Operating temperature (°C)	Storage temperature* (°C)		
MMZ1608	t=0.6mm	-55 to +125	4,000	3
	t=0.8mm	-55 to +125	4,000	4

* The storage temperature range is for after the circuit board is mounted.

- RoHS Directive Compliant Product: See the following for more details. <https://product.tdk.com/info/en/environment/rohs/index.html>
- Halogen-free: indicates that Cl content is less than 900ppm, Br content is less than 900ppm, and that the total Cl and Br content is less than 1500ppm.

 Please be sure to request delivery specifications that provide further details on the features and specifications of the products for proper and safe use.
 Please note that the contents may change without any prior notice due to reasons such as upgrading.

MMZ1608 type

RECOMMENDED REFLOW PROFILE

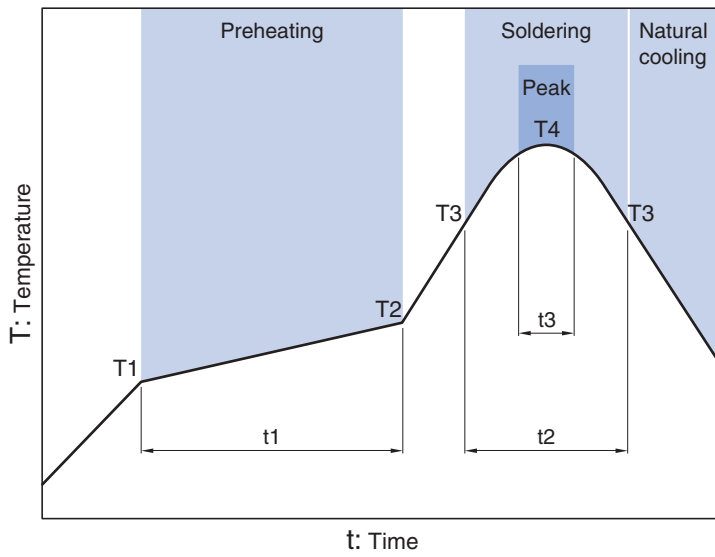

Preheating			Soldering		Peak	
Temp.		Time	Temp.	Time	Temp.	Time
T1	T2	t1	T3	t2	T4	t3
150°C	180°C	60 to 120s	230°C	30 to 60s	250 to 260°C	10s

MMZ1608 type

MATERIAL CHARACTERISTIC

- B material:** This type is perfectly suited for fast digital signals. By equalizing R components and X components that beads possess at a frequency of 5MHz, it is able to suppress overshooting, undershooting and ringing of fast digital signals.
- R material:** For wide frequency applications calling for broad impedance characteristics. For digital signal line applications calling requiring good waveform integrity. Impedance values selected for effectiveness at 10 to 200MHz.
- S material:** Standard type that features impedance characteristics similar to those of a typical ferrite core. For signal line applications in which the blocking region is near 100MHz. Impedance values selected for effectiveness at 40 to 300MHz.
- Y material:** High frequency range type intended for the 100MHz region and above. For signal line applications in which the signal frequency is far from the cutoff frequency. Impedance values selected for effectiveness at 80 to 400MHz.
- A material:** This high-impedance product is based on the impedance frequency characteristics of our Y-material. The product offers excellent impedance characteristics, which is greater than 2500Ω , in the vicinity of 100MHz range (MMZ1608A252B).
- Q material:** High frequency range type intended for the 100MHz region and above. Impedance values selected for effectiveness at 100 to 800MHz.
- D material:** For applications calling for low insertion loss at low frequencies and sharply increasing impedance at high frequencies. Designed for high impedance at high frequencies (300MHz to 1GHz) for signal line applications.
- F material:** This new product inherits the characteristic of our D-material, namely its sharp impedance rise time, and its impedance peak frequency has been shifted higher into range. The product offers excellent noise suppression from 600MHz to as high as in the GHz range.

TYPICAL MATERIAL IMPEDANCE CHARACTERISTICS

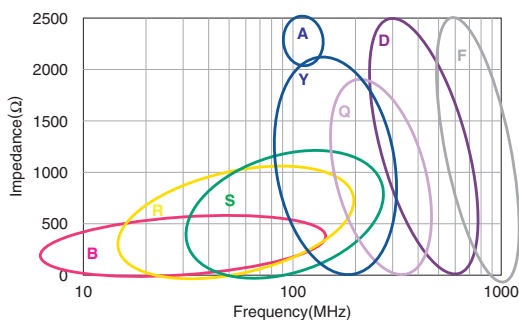

MMZ1608 type

SHAPE & DIMENSIONS

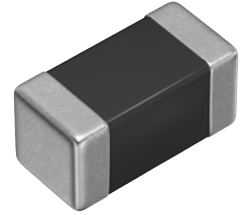
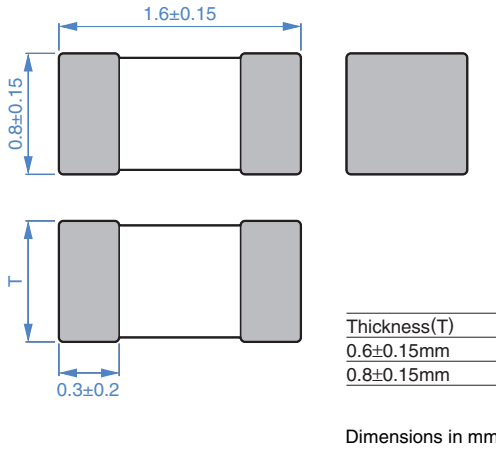

RECOMMENDED LAND PATTERN

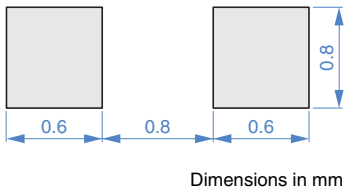

⚠ Please be sure to request delivery specifications that provide further details on the features and specifications of the products for proper and safe use. Please note that the contents may change without any prior notice due to reasons such as upgrading.

MMZ1608 type

ELECTRICAL CHARACTERISTICS

CHARACTERISTICS SPECIFICATION TABLE

Impedance [100MHz] (Ω)		DC resistance (Ω)max.	Rated current (mA)max.	Thickness T (mm)	Part No.
	Tolerance				
120	$\pm 25\%$	0.15	600	0.6	MMZ1608B121CTDH5
220	$\pm 25\%$	0.25	500	0.6	MMZ1608B221CTDH5
300	$\pm 25\%$	0.25	500	0.6	MMZ1608B301CTDH5
470	$\pm 25\%$	0.30	500	0.6	MMZ1608B471CTDH5
600	$\pm 25\%$	0.40	500	0.6	MMZ1608B601CTDH5
1000	$\pm 25\%$	0.60	300	0.8	MMZ1608B102CTD25
15	$\pm 25\%$	0.05	1500	0.8	MMZ1608R150ATD25
30	$\pm 25\%$	0.05	1500	0.8	MMZ1608R300ATD25
60	$\pm 25\%$	0.10	800	0.8	MMZ1608R600ATD25
120	$\pm 25\%$	0.18	500	0.8	MMZ1608R121ATD25
300	$\pm 25\%$	0.25	500	0.8	MMZ1608R301ATD25
470	$\pm 25\%$	0.30	500	0.8	MMZ1608R471ATD25
600	$\pm 25\%$	0.40	500	0.8	MMZ1608R601ATD25
1000	$\pm 25\%$	0.50	400	0.8	MMZ1608R102ATD25
40	$\pm 25\%$	0.10	600	0.8	MMZ1608S400ATD25
80	$\pm 25\%$	0.15	500	0.8	MMZ1608S800ATD25
120	$\pm 25\%$	0.15	500	0.8	MMZ1608S121ATD25
180	$\pm 25\%$	0.20	500	0.8	MMZ1608S181ATD25
220	$\pm 25\%$	0.20	500	0.8	MMZ1608S221ATD25
300	$\pm 25\%$	0.30	500	0.8	MMZ1608S301ATD25
470	$\pm 25\%$	0.30	500	0.8	MMZ1608S471ATD25
600	$\pm 25\%$	0.35	500	0.8	MMZ1608S601ATD25
1000	$\pm 25\%$	0.50	400	0.8	MMZ1608S102ATD25
2000	$\pm 25\%$	0.90	200	0.8	MMZ1608S202ATD25
15	$\pm 25\%$	0.05	1500	0.8	MMZ1608Y150BTD25
30	$\pm 25\%$	0.05	1500	0.8	MMZ1608Y300BTD25
60	$\pm 25\%$	0.15	500	0.8	MMZ1608Y600BTD25
120	$\pm 25\%$	0.20	500	0.8	MMZ1608Y121BTD25
220	$\pm 25\%$	0.30	500	0.8	MMZ1608Y221BTD25
300	$\pm 25\%$	0.30	500	0.8	MMZ1608Y301BTD25
470	$\pm 25\%$	0.35	500	0.8	MMZ1608Y471BTD25
600	$\pm 25\%$	0.40	500	0.8	MMZ1608Y601BTD25
750	$\pm 25\%$	0.45	500	0.8	MMZ1608Y751BTD25
1000	$\pm 25\%$	0.50	400	0.8	MMZ1608Y102BTD25
1500	$\pm 25\%$	0.60	300	0.8	MMZ1608Y152BTD25
1800	$\pm 25\%$	0.80	200	0.8	MMZ1608A182BTD25
2200	$\pm 25\%$	0.80	200	0.8	MMZ1608A222BTD25
2500	$\pm 25\%$	0.80	200	0.8	MMZ1608A252BTD25
120	$\pm 25\%$	0.30	500	0.8	MMZ1608Q121BTD25
220	$\pm 25\%$	0.40	500	0.8	MMZ1608Q221BTD25
330	$\pm 25\%$	0.50	400	0.8	MMZ1608Q331BTD25
470	$\pm 25\%$	0.70	300	0.8	MMZ1608Q471BTD25
600	$\pm 25\%$	0.80	200	0.8	MMZ1608Q601BTD25
1000	$\pm 25\%$	1.00	200	0.8	MMZ1608Q102BTD25

○ Measurement equipment

Measurement item	Product No.	Manufacturer
Impedance	E4991A+16192A	Keysight Technologies
DC resistance	Type-7556	Yokogawa

* Equivalent measurement equipment may be used.

 Please be sure to request delivery specifications that provide further details on the features and specifications of the products for proper and safe use.
Please note that the contents may change without any prior notice due to reasons such as upgrading.

MMZ1608 type

ELECTRICAL CHARACTERISTICS

CHARACTERISTICS SPECIFICATION TABLE

Impedance [100MHz] (Ω)		DC resistance (Ω)max.	Rated current (mA)max.	Thickness T (mm)	Part No.
	Tolerance				
5	$\pm 2\Omega$	0.05	700	0.8	MMZ1608D050CTD25
10	$\pm 5\Omega$	0.10	500	0.6	MMZ1608D100CTDH5
22	$\pm 25\%$	0.20	500	0.6	MMZ1608D220CTDH5
50	$\pm 25\%$	0.25	500	0.6	MMZ1608D500CTDH5
80	$\pm 25\%$	0.30	500	0.6	MMZ1608D800CTDH5
80	$\pm 25\%$	0.30	500	0.8	MMZ1608D800BTD25
120	$\pm 25\%$	0.30	400	0.6	MMZ1608D121CTDH5
120	$\pm 25\%$	0.30	400	0.8	MMZ1608D121BTD25
240	$\pm 25\%$	0.60	300	0.8	MMZ1608D241CTD25
300	$\pm 25\%$	0.70	300	0.8	MMZ1608D301BTD25
3typ.		0.05	700	0.8	MMZ1608F030BTD25
47	$\pm 25\%$	0.40	500	0.8	MMZ1608F470BTD25
75	$\pm 25\%$	0.55	300	0.8	MMZ1608F750BTD25
120	$\pm 25\%$	0.75	200	0.8	MMZ1608F121BTD25

Measurement equipment

Measurement item	Product No.	Manufacturer
Impedance	E4991A+16192A	Keysight Technologies
DC resistance	Type-7556	Yokogawa

* Equivalent measurement equipment may be used.

MMZ1608 type

ELECTRICAL CHARACTERISTICS

Z VS. FREQUENCY CHARACTERISTICS (BY SERIES)

MMZ1608B series

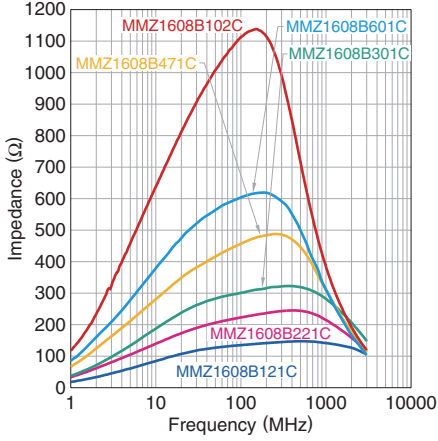

MMZ1608R series

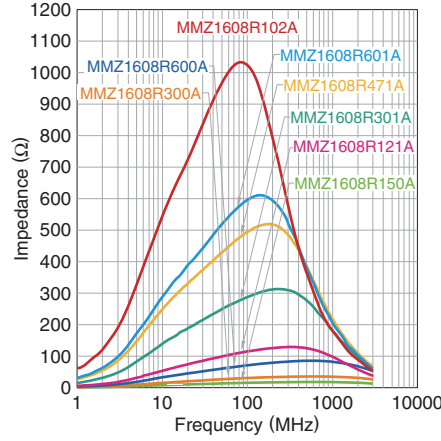

MMZ1608S series

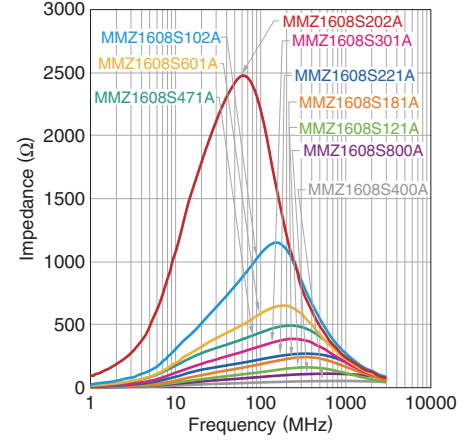

MMZ1608Y series

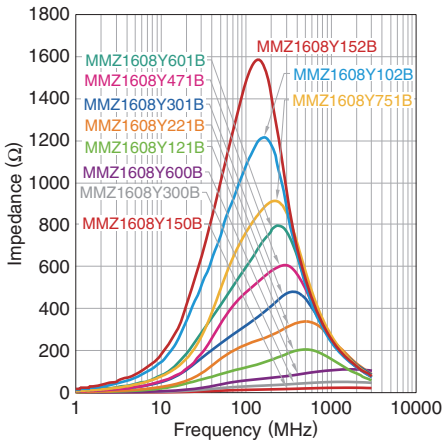

MMZ1608A series

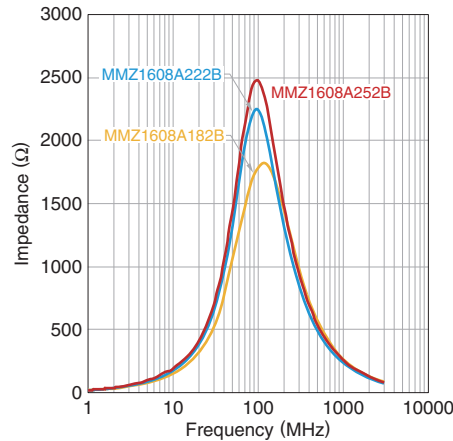

MMZ1608Q series

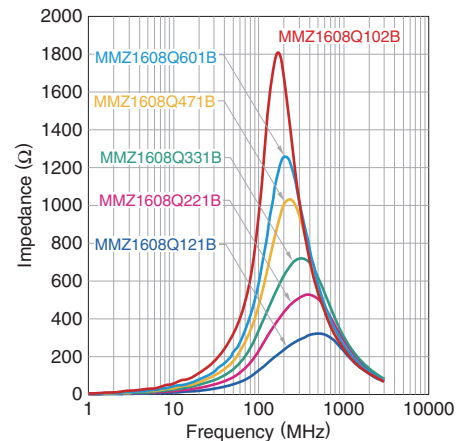

MMZ1608D series

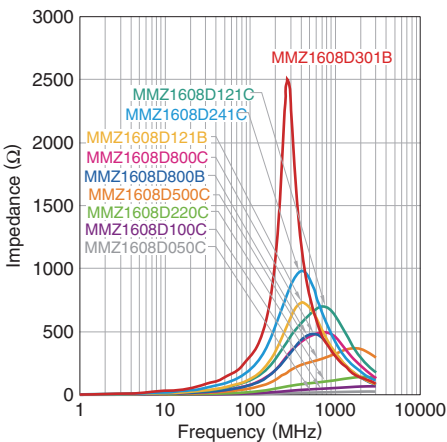

MMZ1608F series

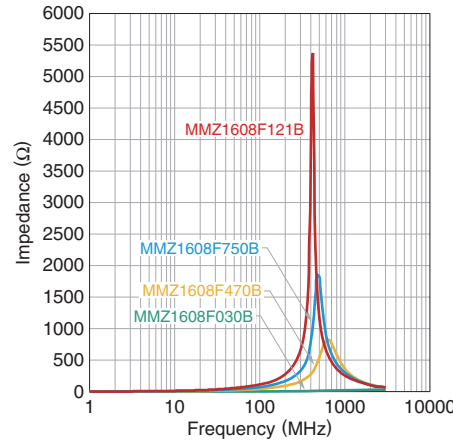

⚠ Please be sure to request delivery specifications that provide further details on the features and specifications of the products for proper and safe use. Please note that the contents may change without any prior notice due to reasons such as upgrading.

MMZ1608 type

ELECTRICAL CHARACTERISTICS

Z, X, R VS. FREQUENCY CHARACTERISTICS

MMZ1608B121CTDH5

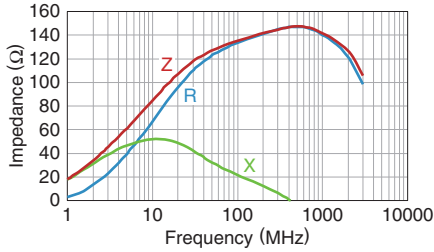

MMZ1608B221CTDH5

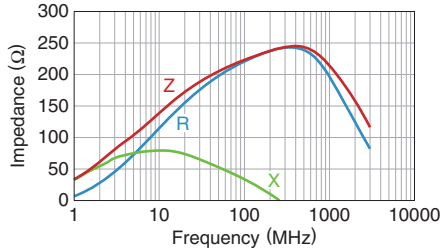

MMZ1608B301CTDH5

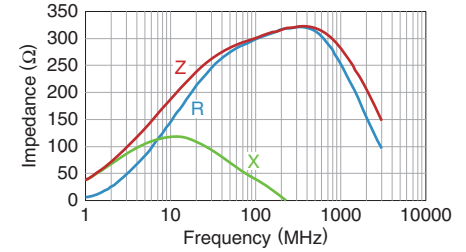

MMZ1608B471CTDH5

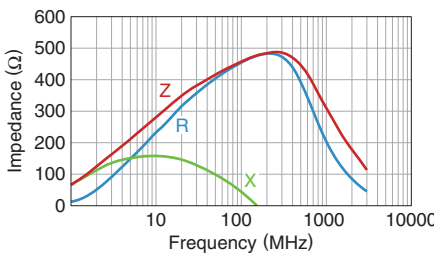

MMZ1608B601CTDH5

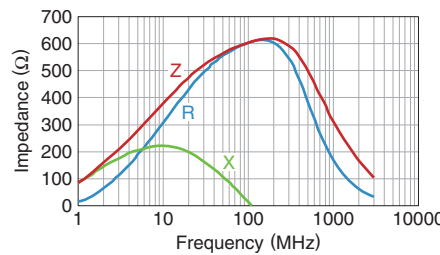

MMZ1608B102CTD25

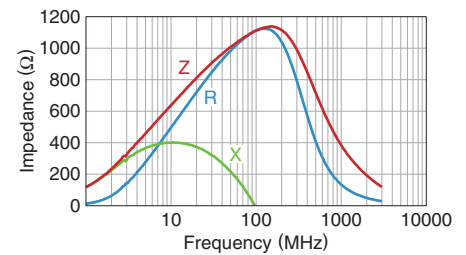

MMZ1608R150ATD25

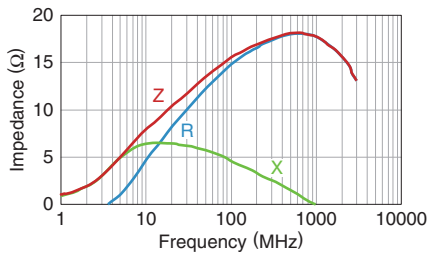

MMZ1608R300ATD25

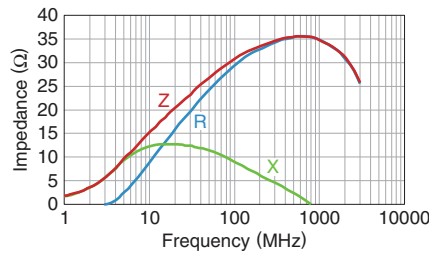

MMZ1608R600ATD25

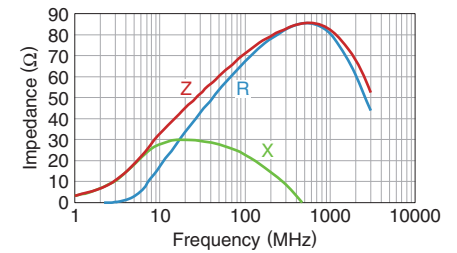

MMZ1608R121ATD25

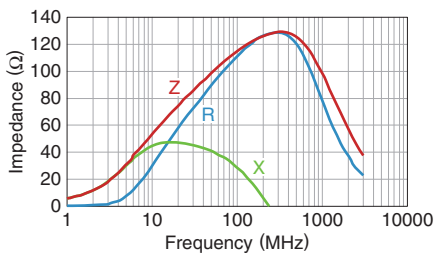

MMZ1608R301ATD25

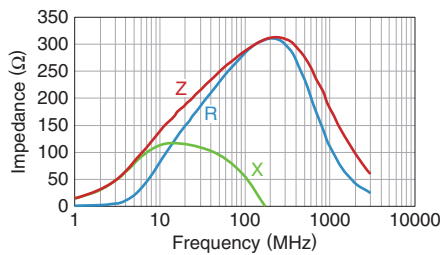

MMZ1608R471ATD25

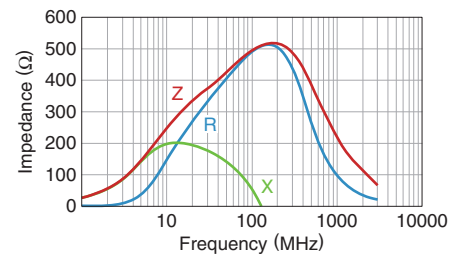

MMZ1608R601ATD25

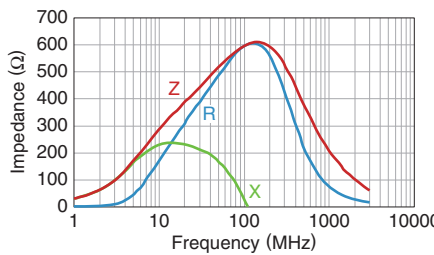

MMZ1608R102ATD25

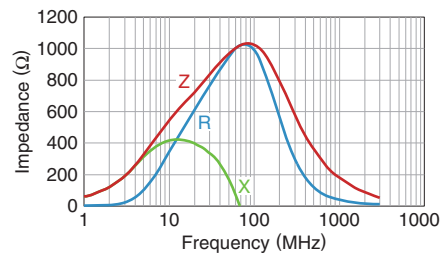

MMZ1608S400ATD25

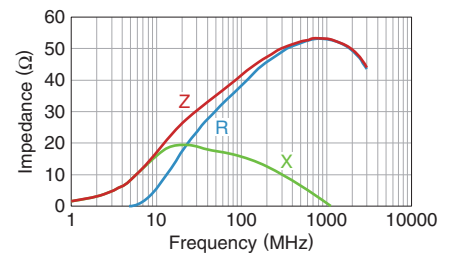

 Please be sure to request delivery specifications that provide further details on the features and specifications of the products for proper and safe use. Please note that the contents may change without any prior notice due to reasons such as upgrading.

MMZ1608 type

ELECTRICAL CHARACTERISTICS

Z, X, R VS. FREQUENCY CHARACTERISTICS

MMZ1608S800ATD25

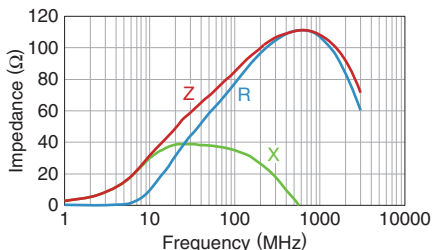

MMZ1608S121ATD25

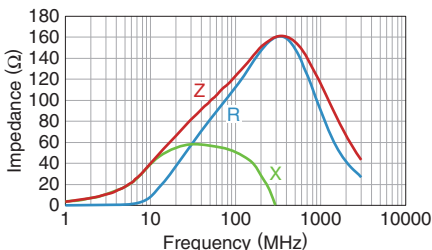

MMZ1608S181ATD25

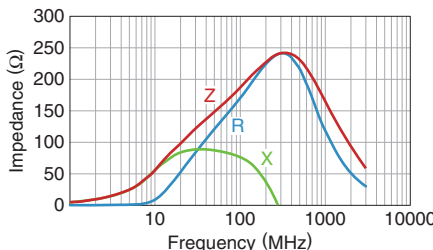

MMZ1608S221ATD25

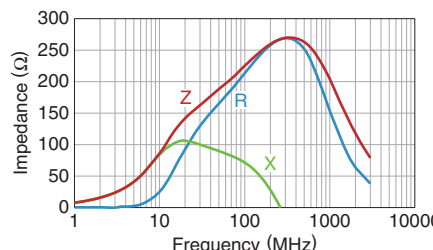

MMZ1608S301ATD25

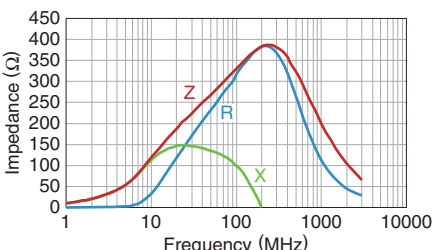

MMZ1608S471ATD25

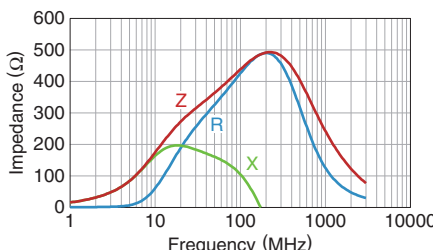

MMZ1608S601ATD25

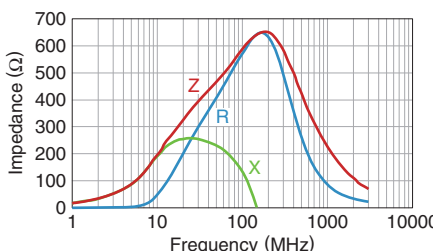

MMZ1608S102ATD25

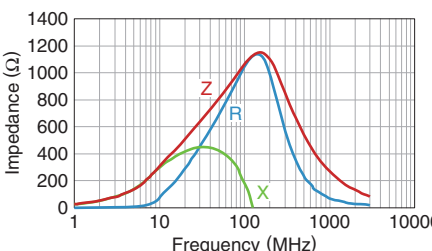

MMZ1608S202ATD25

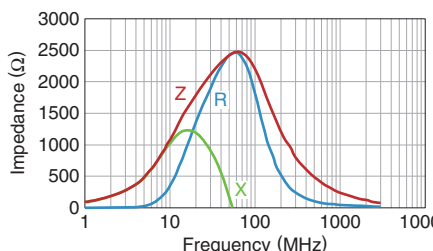

MMZ1608Y150BTD25

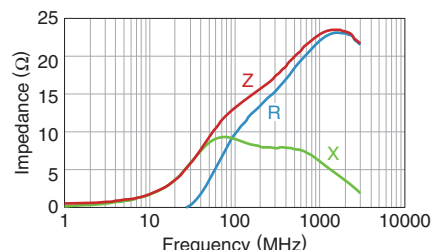

MMZ1608Y300BTD25

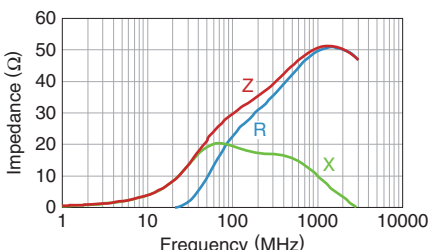

MMZ1608Y600BTD25

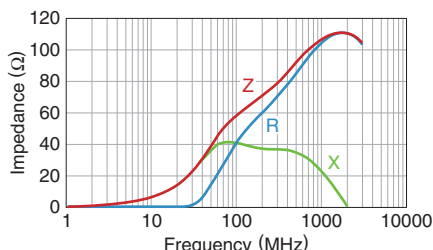

MMZ1608Y121BTD25

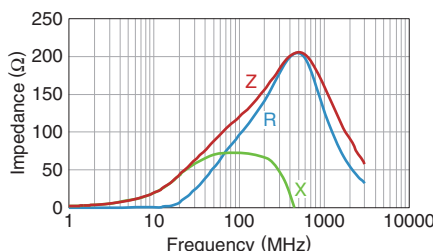

MMZ1608Y221BTD25

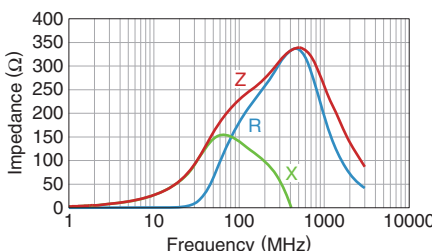

MMZ1608Y301BTD25

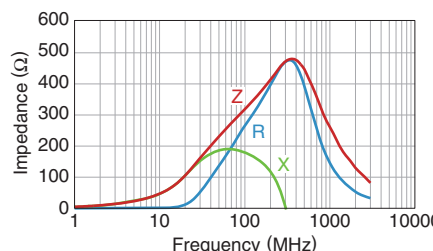

⚠ Please be sure to request delivery specifications that provide further details on the features and specifications of the products for proper and safe use. Please note that the contents may change without any prior notice due to reasons such as upgrading.

MMZ1608 type

ELECTRICAL CHARACTERISTICS

Z, X, R VS. FREQUENCY CHARACTERISTICS

MMZ1608Y471BTD25

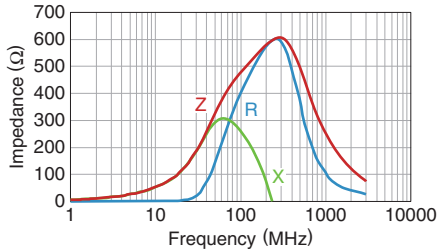

MMZ1608Y601BTD25

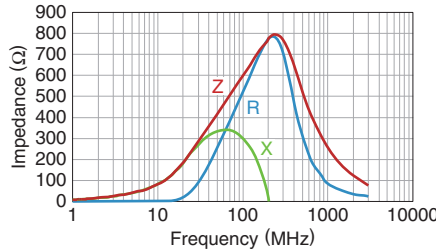

MMZ1608Y751BTD25

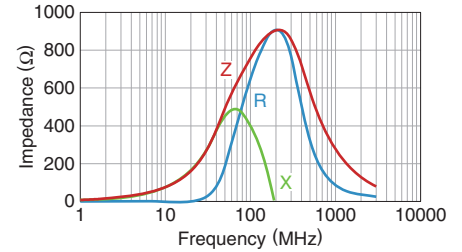

MMZ1608Y102BTD25

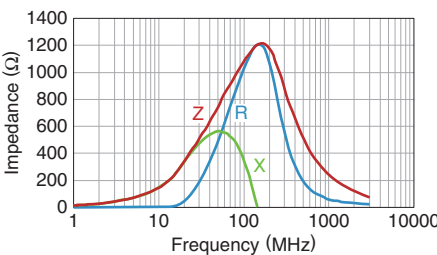

MMZ1608Y152BTD25

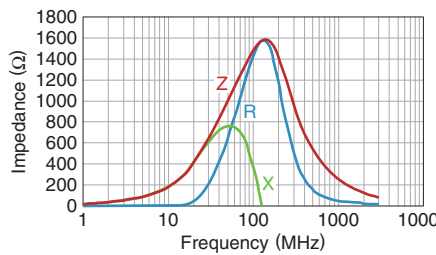

MMZ1608A182BTD25

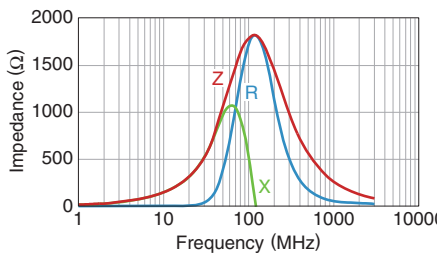

MMZ1608A222BTD25

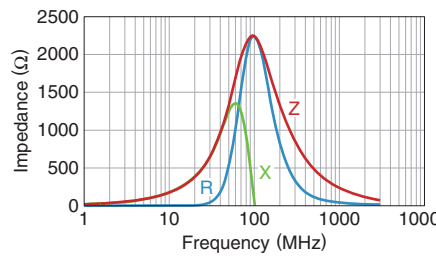

MMZ1608A252BTD25

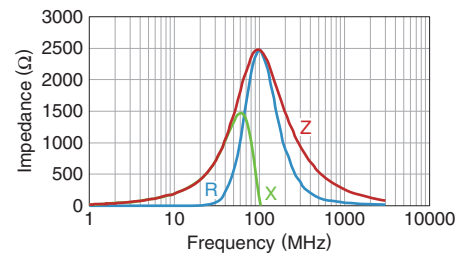

MMZ1608Q121BTD25

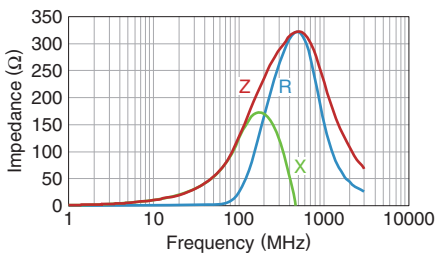

MMZ1608Q221BTD25

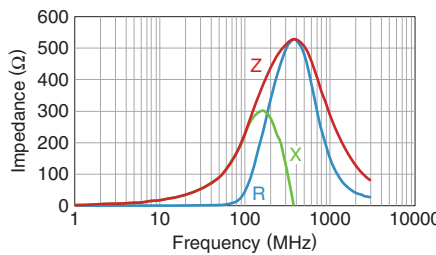

MMZ1608Q331BTD25

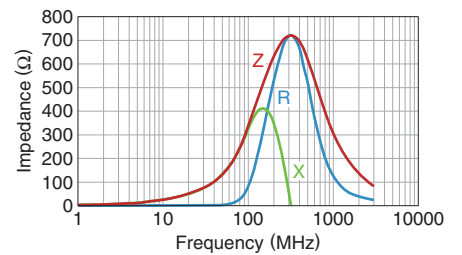

MMZ1608Q471BTD25

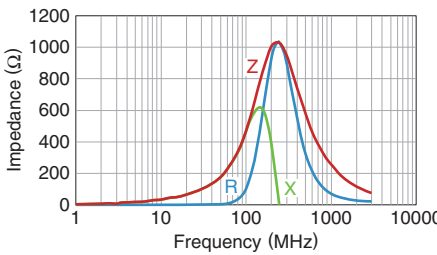

MMZ1608Q601BTD25

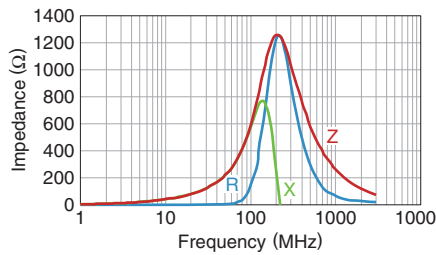

MMZ1608Q102BTD25

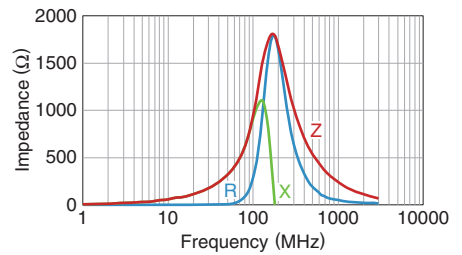

 Please be sure to request delivery specifications that provide further details on the features and specifications of the products for proper and safe use. Please note that the contents may change without any prior notice due to reasons such as upgrading.

MMZ1608 type

ELECTRICAL CHARACTERISTICS

Z, X, R VS. FREQUENCY CHARACTERISTICS

MMZ1608D050CTD25

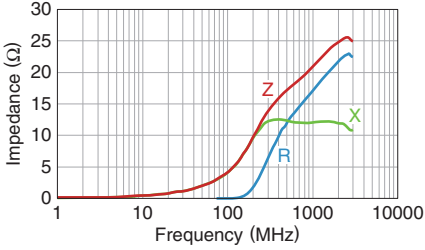

MMZ1608D100CTDH5

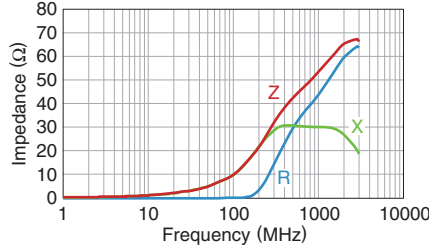

MMZ1608D220CTDH5

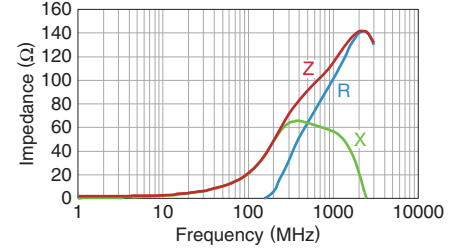

MMZ1608D500CTDH5

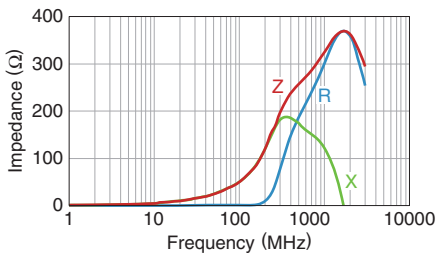

MMZ1608D800CTDH5

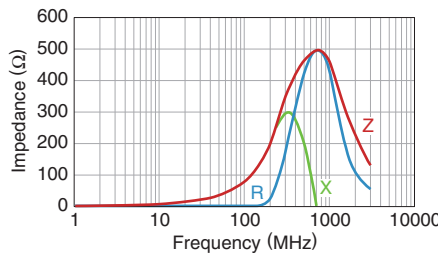

MMZ1608D800BTD25

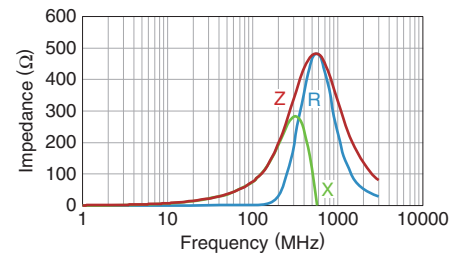

MMZ1608D121CTDH5

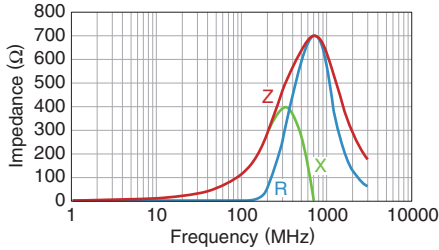

MMZ1608D121BTD25

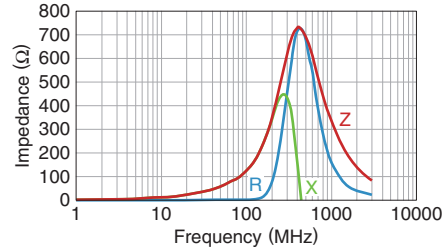

MMZ1608D241CTD25

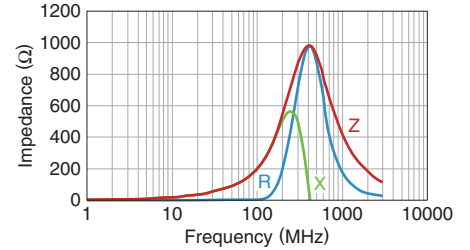

MMZ1608D301BTD25

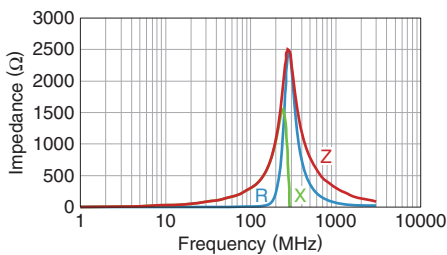

MMZ1608F030BTD25

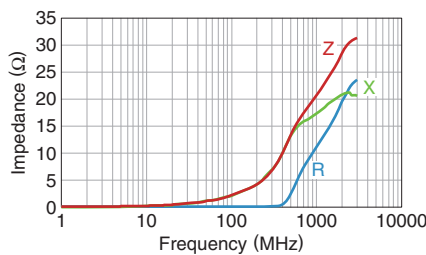

MMZ1608F470BTD25

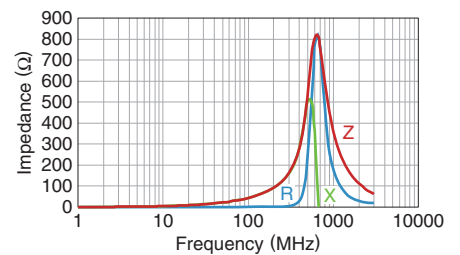

MMZ1608F750BTD25

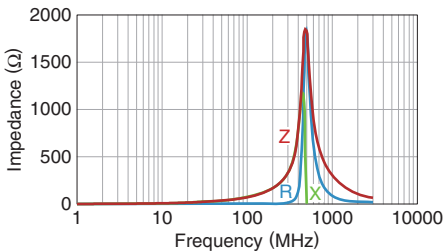

MMZ1608F121BTD25

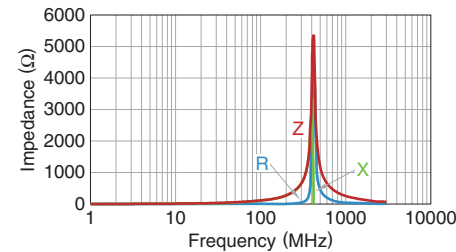

⚠ Please be sure to request delivery specifications that provide further details on the features and specifications of the products for proper and safe use.
Please note that the contents may change without any prior notice due to reasons such as upgrading.

MMZ1608 type

PACKAGING STYLE

REEL DIMENSIONS

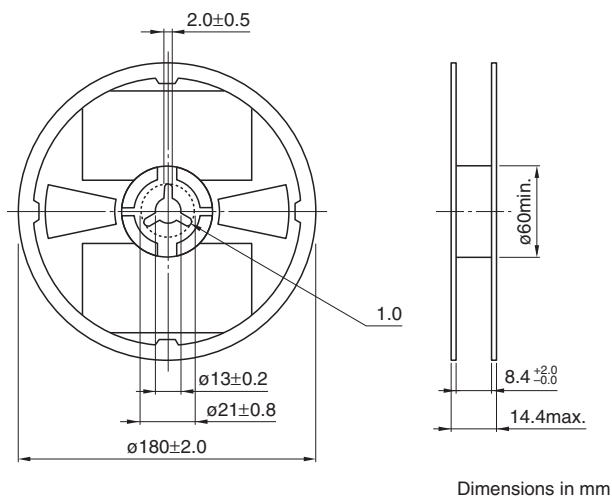

TAPE DIMENSIONS

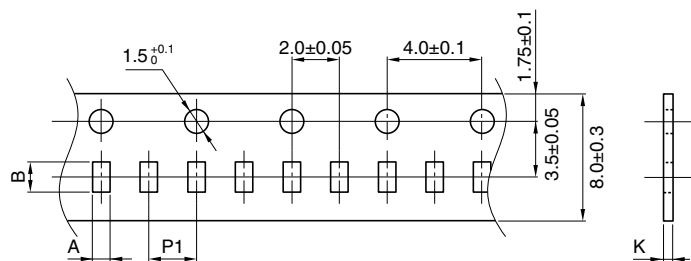

Type	A	B	P1	K
MMZ1608	1.1±0.2	1.9±0.2	4.0±0.1	1.1max.

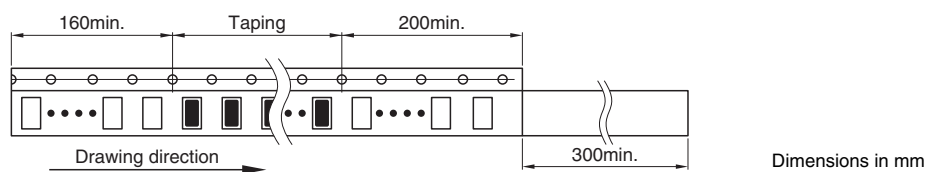

⚠ Please be sure to request delivery specifications that provide further details on the features and specifications of the products for proper and safe use. Please note that the contents may change without any prior notice due to reasons such as upgrading.