

Dual Precision Operational Amplifier

DESCRIPTION

The **RH1013M** is the first precision dual operational amplifier which directly upgrades designs in the industry standard 8-pin DIP LM158/MC1558/OP-221 pin configuration. Low offset voltage (300 μ V max), low drift ($\leq 2.5\mu$ V/ $^{\circ}$ C), low offset current (≤ 1.5 nA), and high gain (1.2 million min) combine to make the RH1013M two truly precision amplifiers in one package.

The wafer lots are processed to Analog Devices' in-house Class S flow to yield circuits usable in stringent military applications.

ABSOLUTE MAXIMUM RATINGS

Supply Voltage	± 22 V
Differential Input Voltage	± 30 V
Input Voltage	Equal to Positive Supply Voltage
.....	5V Below Negative Supply Voltage
Output Short-Circuit Duration	Indefinite
Operating Temperature Range	-55° C to 125° C
Storage Temperature Range	-65° C to 150° C
Lead Temperature (Soldering, 10 sec).....	300° C

All registered trademarks and trademarks are the property of their respective owners.

BURN-IN CIRCUIT

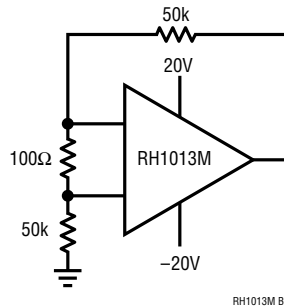

TOTAL DOSE BIAS CIRCUIT

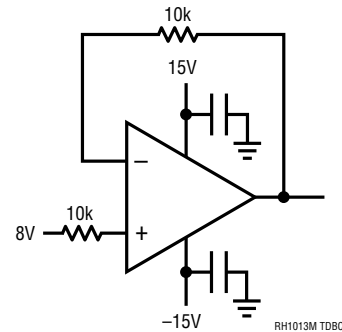

PACKAGE/ORDER INFORMATION

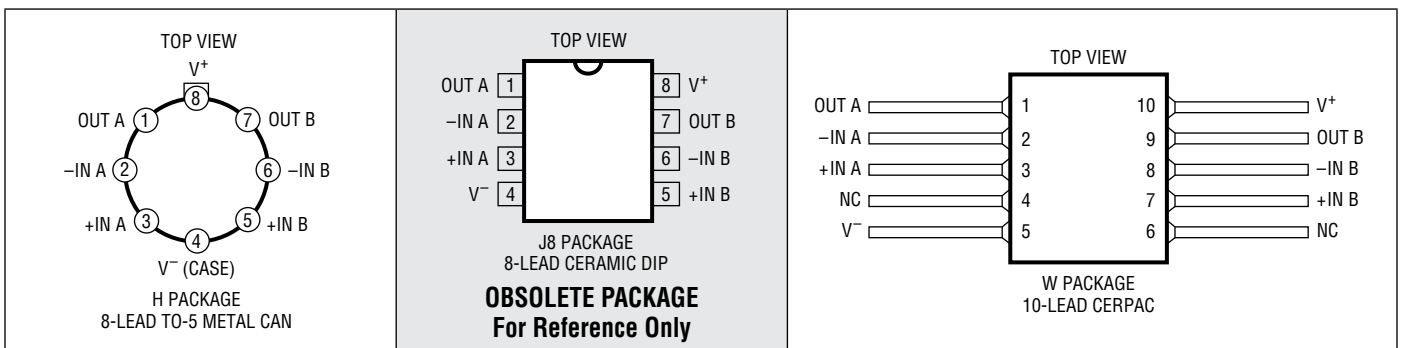

RH1013M

TABLE 1: ELECTRICAL CHARACTERISTICS (Preirradiation)

$V_S = \pm 15V$, $V_{CM} = 0V$, unless otherwise noted.

SYMBOL	PARAMETER	CONDITIONS	NOTES	$T_A = 25^\circ C$			SUB-GROUP	$-55^\circ C \leq T_A \leq 125^\circ C$			SUB-GROUP	UNITS
				MIN	TYP	MAX		MIN	TYP	MAX		
V_{OS}	Input Offset Voltage					300	1		550	2,3	μV	
			2			450	1		750	3	μV	
		$V_{CM} = 0.1V$							750	2	μV	
$\frac{\Delta V_{OS}}{\Delta Temp}$	Average Tempco of Offset Voltage		1						2.5		$\mu V/^\circ C$	
$\frac{\Delta V_{OS}}{\Delta Time}$	Long Term V_{OS} Stability				0.5						$\mu V/Mo$	
I_{OS}	Input Offset Current					10	1		20	2,3	nA	
			2			10	1		20	2,3	nA	
I_B	Input Bias Current					30	1		45	2,3	nA	
			2			50	1		120	2,3	nA	
e_n	Input Noise Voltage	0.1Hz to 10Hz			0.55						μV_{p-p}	
	Input Noise Voltage Density	$f_0 = 10Hz$			24						nV/\sqrt{Hz}	
		$f_0 = 1000Hz$				22					nV/\sqrt{Hz}	
i_n	Input Noise Current Density	$f_0 = 10Hz$			0.07						pA/\sqrt{Hz}	
R_{IN}	Input Resistance	Differential	1	70							$M\Omega$	
		Common Mode			4						$G\Omega$	
A_{VOL}	Large-Signal Voltage Gain	$V_0 = \pm 10V$, $R_L \geq 2k$		1.2			4	0.25		5,6	$V/\mu V$	
		$V_0 = \pm 10V$, $R_L \geq 600\Omega$		0.5			4				$V/\mu V$	
		$V_0 = 5mV$ to $4V$, $R_L = 500\Omega$	2	1							$V/\mu V$	
	Input Voltage Range		1	13.5							V	
			1	-15.0							V	
			1,2	3.5							V	
			1,2	0							V	
CMRR	Common-Mode Rejection Ratio	$V_{CM} = 13.5V$, $-15V$		97			1				dB	
		$V_{CM} = 13V$, $-14.9V$						94		2,3	dB	
PSRR	Power Supply Rejection Ratio	$V_S = \pm 2V$ to $\pm 18V$		100			1	97		2,3	dB	
	Channel Separation	$V_0 = \pm 10V$, $R_L = 2k$		120			1				dB	
V_{OUT}	Output Voltage Swing	$R_L \geq 2k$		± 12.5			4	± 11.5		5,6	V	
		Output Low, No Load	2		25	4					mV	
		Output Low, 600Ω to GND	2		10	4		18	5,6		mV	
		Output Low, $I_{SINK} = 1mA$	2		350	4					mV	
		Output High, No Load	2	4.0		4					V	
		Output High, 600Ω to GND	2	3.4		4	3.1		5,6		V	
SR	Slew Rate			0.2			4				$V/\mu s$	
I_S	Supply Current	Per Amplifier			0.55	1		0.70	2,3		mA	
			2		0.50	1		0.65	2,3		mA	

Rev. F

TABLE 1A: ELECTRICAL CHARACTERISTICS (Postirradiation) $V_S = \pm 15V$, $V_{CM} = 0V$, $T_A = 25^\circ C$, unless otherwise noted.

SYMBOL	PARAMETER	CONDITIONS	NOTES	10KRAD (Si)		20KRAD (Si)		50KRAD (Si)		100KRAD (Si)		200KRAD (Si)		UNITS
				MIN	MAX	MIN	MAX	MIN	MAX	MIN	MAX	MIN	MAX	
V_{OS}	Input Offset Voltage			450	450	600	750	900					μV	
			2	600	600	750	900					μV		
I_{OS}	Input Offset Current			10	10	15	20	25					nA	
			2	10	10	15	20					nA		
I_B	Input Bias Current			60	75	100	175	250					nA	
			2	80	100	125	200					nA		
	Input Voltage Range		1	13.5	13.5	13.5	13.5	13.5					V	
			1	-15.0	-15.0	-15.0	-15.0	-15.0					V	
			2	3.5	3.5	3.5	3.5						V	
			2	0	0	0	0						V	
CMRR	Common-Mode Rejection Ratio	$V_{CM} = 13V, -15V$		97	97	94	90	86					dB	
PSRR	Power Supply Rejection Ratio	$V_S = \pm 10V$ to $\pm 18V$		100	98	94	86	80					dB	
A_{VOL}	Large-Signal Voltage Gain	$R_L \geq 10k$, $V_O = \pm 10V$		500	200	100	50	25					V/mV	
V_{OUT}	Maximum Output Voltage Swing	$R_L \geq 10k$		± 12.5	± 12.5	± 12.5	± 12.5	± 12.5					V	
			2	25	30	40	50					mV		
			2	10	10	10	10					mV		
			2	0.6	0.8	1.0	1.6					V		
			2	4.0	4.0	4.0	4.0					V		
			2	3.4	3.2	3.0	2.8					V		
SR	Slew Rate	$R_L \geq 10k$		0.13	0.12	0.11	0.07	0.01					V/ μs	
I_S	Supply Current	Per Amplifier		0.55	0.55	0.55	0.55	0.55					mA	
			2	0.50	0.50	0.50	0.50					mA		

Note 1: Guaranteed by design, characterization, or correlation to other tested parameters.

Note 2: Specification applies for $V_{S+} = 5V$, $V_{S-} = 0V$, $V_{CM} = 0V$, $V_{OUT} = 1.4V$.

TABLE 2: ELECTRICAL TEST REQUIREMENTS

MIL-STD-883 TEST REQUIREMENTS	SUBGROUP
Final Electrical Test Requirements (Method 5004)	1*, 2, 3, 4, 5, 6
Group A Test Requirements (Method 5005)	1, 2, 3, 4, 5, 6
Group B and D for Class S, and Group C and D for Class B End Point Electrical Parameters (Method 5005)	1, 2, 3

* PDA applies to subgroup 1. See PDA Test Notes.

PDA Test Notes

The PDA is specified as 5% based on failures from group A, subgroup 1, tests after cooldown as the final electrical test in accordance with method 5004 of MIL-STD-883. The verified failures of group A, subgroup 1, after burn-in divided by the total number of devices submitted for burn-in in that lot shall be used to determine the percent for the lot.

Analog Devices, Inc. reserves the right to test to tighter limits than those given.

TYPICAL PERFORMANCE CHARACTERISTICS

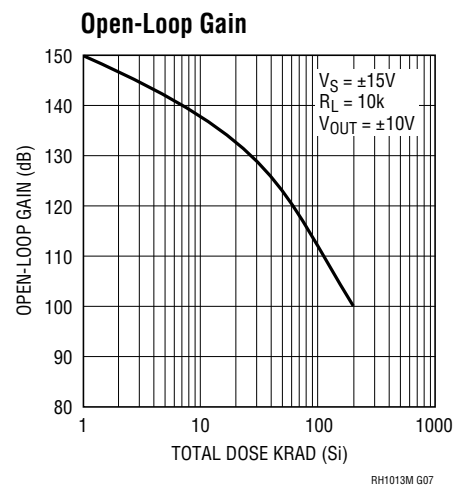
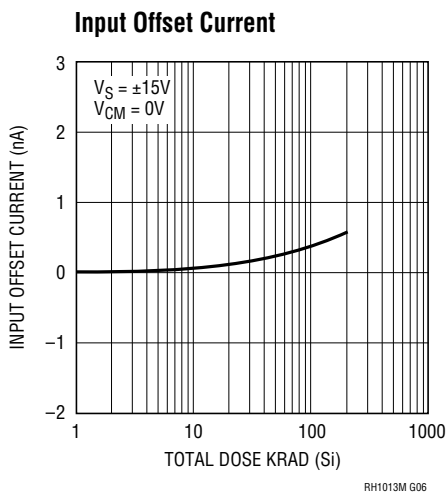
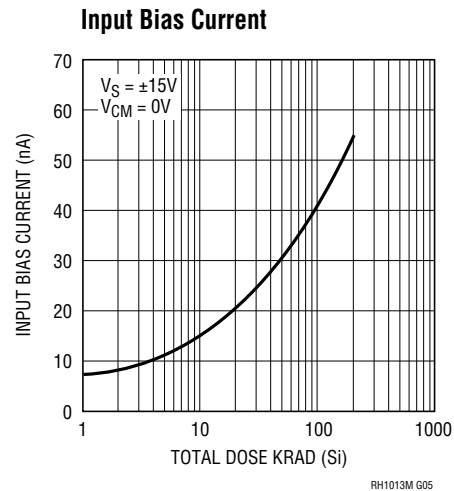
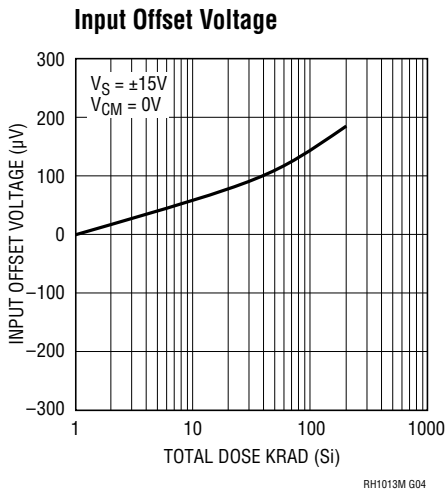
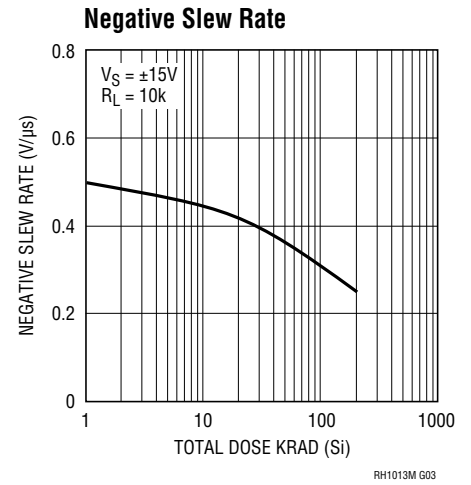
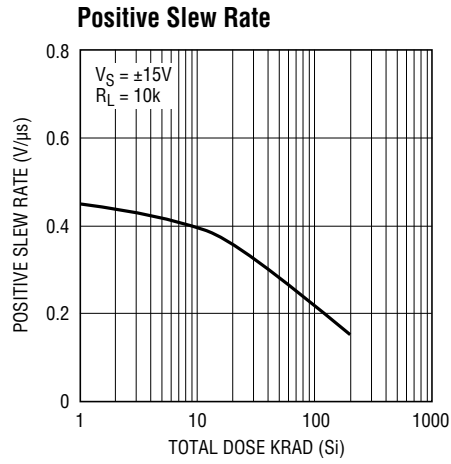
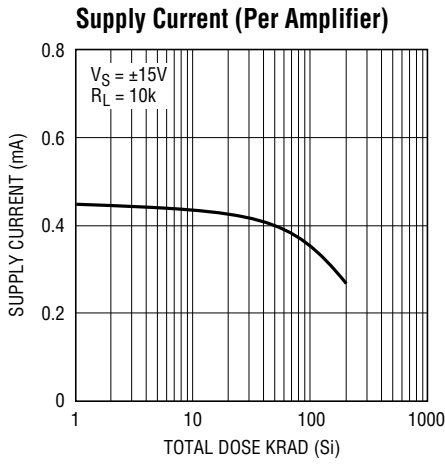

TYPICAL PERFORMANCE CHARACTERISTICS

Common-Mode Rejection Ratio

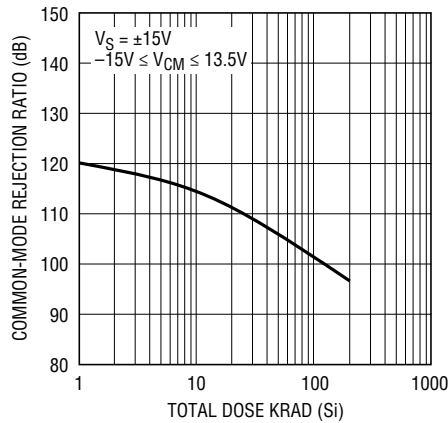

RH1013M G08

Power Supply Rejection Ratio

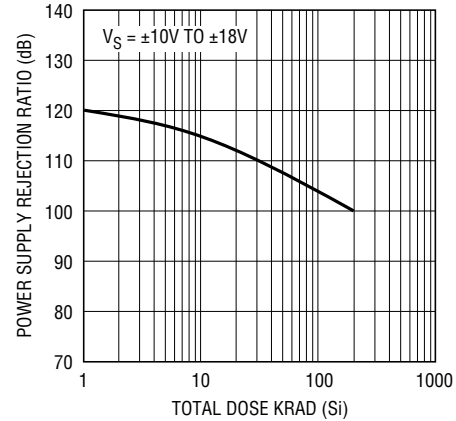

RH1013M G09

Input Noise Voltage Density

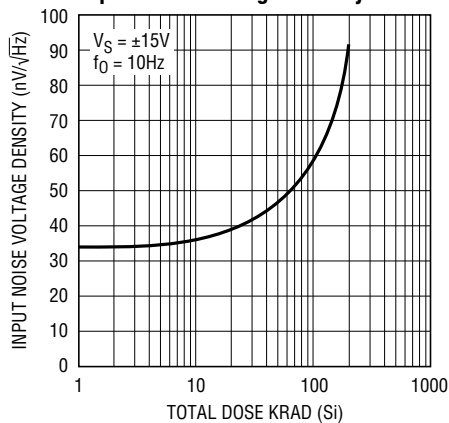

RH1013M G10

Gain Bandwidth Product

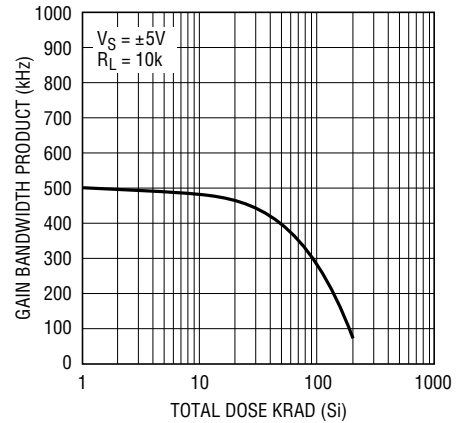

RH1013M G11

REVISION HISTORY (Revision history begins at Rev F)

REV	DATE	DESCRIPTION	PAGE NUMBER
F	02/19	Obsoleting J8 packaging and updating document to ADI format	All Pages

RH1013M

RAD HARD

This table provides example specifications for our Rad Hard products. For complete Rad Hard data sheets, contact Analog Devices, Inc.

DEVICE	SYMBOL	CONDITIONS	10KRAD (Si)		20KRAD (Si)		50KRAD (Si)		80KRAD (Si)		100KRAD (Si)		200KRAD (Si)		UNITS	PACKAGE OPTIONS
			MIN	MAX	MIN	MAX	MIN	MAX	MIN	MAX	MIN	MAX	MIN	MAX		
RH07	V_{OS} I_{OS}		90 2.8	150 4	200 8					250 12	300 20	μV nA	J8, H			
RH27C	V_{OS} I_{OS}		100 75	130 75	180 90					280 120	400 180	μV nA	H, W			
RH37C	V_{OS} I_{OS}		100 75	130 75	180 90					280 120	400 180	μV nA	H, W			
RH101A	V_{OS} I_{OS}		2 10	2 10	2 10					2 10	3 20	mV nA	H, W			
RH108A	V_{OS} I_{OS}		0.5 0.2	0.5 0.2	0.5 0.2	1.0 0.2						mV nA	H, W			
RH117	V_{REF}	$3V \leq (V_{IN} - V_{OUT}) \leq 40V$ $10mA \leq I_{OUT} \leq I_{MAX}, P \leq P_{MAX}$	1.20	1.30	1.20	1.30	1.20	1.30			1.20	1.30	V	H, K		
RH118	V_{OS} SR	$V_S = \pm 15V, A_V = 1$	50	4	50	4	50	4			50	4	10	mV V/ μs	H, W	
RH119	V_{OS} I_{OS}		4 75	4 100	4 150					4 300	8 500	mV nA	H, J, W			
RH129	V_Z $\Delta V_Z / \Delta TEMP$	RH129A RH129B RH129C	6.7 7.2 10 20 50	6.7 7.2 10 20 50	6.7 7.2 10 20 50					6.7 7.2 15 25 55	6.7 7.2 20 30 60	V ppm/ $^{\circ}C$ ppm/ $^{\circ}C$ ppm/ $^{\circ}C$	H			
RH137	V_{REF}	$ V_{IN} - V_{OUT} \leq 5V, I_{OUT} = 10mA$ $3V \leq V_{IN} - V_{OUT} \leq 40V$ $10mA \leq I_{OUT} \leq I_{MAX}, P \leq P_{MAX}$	-1.225 -1.275 -1.2 -1.3	-1.225 -1.275 -1.2 -1.3	-1.225 -1.275 -1.2 -1.3					-1.225 -1.275 -1.2 -1.3	-1.22 -1.23 -1.2 -1.3	V V	K, H			
RH1009	V_Z $\Delta V_Z / \Delta I_Z$		2.495 2.505 6	2.495 2.505 6	2.495 2.505 8					2.495 2.505 10	2.495 2.505 12	V mV	H			
RH1011	V_{OS} I_{OS}		1.5 4	1.5 4	1.5 4					1.5 20	2 50	mV nA	H, J8, W			
RH1013	V_{OS} I_{OS}		450 10	450 10	600 15					750 20	900 25	μV nA	H, J8, W			
RH1014	V_{OS} I_{OS}		450 10	450 10	600 15					750 20	900 25	μV nA	J, W			
RH1021-5	V_{OUT} TCV_{OUT}	RH1021CM-5 RH1021BM-5, DM-5 RH1021BM-5 RH1021CM-5, DM-5	4.9975 5.0025 4.95	4.995 5.005 4.945 5.055 5 20	4.993 5.007 4.942 5.058 5 20					4.9925 5.008 4.94 5.06 7 22	4.99 5.01 4.935 5.065 10 25	V V ppm/ $^{\circ}C$ ppm/ $^{\circ}C$	H			
RH1021-7	V_{OUT} TCV_{OUT}	RH1021BM-7 RH1021DM-7	6.95 7.05 5 20	6.95 7.05 5 20	6.95 7.05 5 20					6.94 7.06 7 22	6.93 7.07 10 25	V V ppm/ $^{\circ}C$ ppm/ $^{\circ}C$	H			
RH1021-10	V_{OUT} TCV_{OUT}	RH1021CM-10 RH1021BM-10, DM-10 RH1021BM-10 RH1021CM-10, DM-10	9.995 10.005 9.95 10.05 5 20	9.99 10.01 9.945 10.055 5 20	9.987 10.013 9.942 10.06 5 20					9.985 10.015 9.98 10.06 7 22	9.98 10.02 9.935 10.065 10 25	V V ppm/ $^{\circ}C$ ppm/ $^{\circ}C$	H			
RH1056A	V_{OS} I_{OS}		180 ± 10	180 ± 50	250 ± 150					450 ± 250	450 ± 350	μV pA	H, W			
RH1078	V_{OS} I_{OS}		350 2	500 18	650 13	75k 18	800			1000 23		μV nA	H, J8, W J, W			
RH1086	V_{REF} Dropout V	$I_{OUT} = 10mA$ $10mA \leq I_{OUT} \leq I_{FULL LOAD}$ $1.5V \leq (V_{IN} - V_{OUT}) \leq 15V$ $\Delta V_{REF} = 1\%, I_{OUT} = 1.5A (K)$ $\Delta V_{REF} = 1\%, I_{OUT} = 0.5A (H)$	1.258 1.271 1.5	1.257 1.269 1.51	1.253 1.265 1.52					1.247 1.260 1.55	1.241 1.253 1.575	V V V	H, K			