

FEATURES

Single Supply Operation:

- Input Goes Below Ground
- Output Swings to Ground Sinking Current
- No Pull-Down Resistors Needed
- Phase Reversal Protection

At 5V, 0V Low Cost Grade Specifications:

- 280 μ V Max Offset Voltage
- 380 μ V Max in S8 Package
- 0.8nA Max Offset Current
- 480 μ A Max Supply Current per Amplifier
- 0.5 μ V/ $^{\circ}$ C Drift
- 1.4 Million Voltage Gain
- 950kHz Gain-Bandwidth Product
- 0.55 μ V_{p-p}, 0.1Hz to 10Hz Noise

APPLICATIONS

- Single Supply Systems
- Two and Three Op Amp Instrumentation Amplifiers
- Active Filters
- Battery-Powered Systems
- Strain Gauge and Bridge Amplifiers

DESCRIPTION

The LT1413 is a low cost, upgraded version of Linear Technology's industry standard LT1013 dual, single supply op amp. The LT1413 is optimized for single 5V applications, although ± 15 V specifications are also provided for completeness.

In the design of the LT1413, particular emphasis has been placed on low cost plastic and SO-8 package performance: 60 μ V offset voltage, 0.1nA offset current, in excess of 10mA output current at 330 μ A supply current and 140dB channel separation are some of the specifications achieved.

Other dual, single supply amplifiers are available to complement the LT1413 family: the micropower LT1078's supply current is 10 times lower with a 4.5 fold speed performance degradation compared to the LT1413. Conversely, the LT1211, LT1213 and LT1215 duals have 4 to 14 times higher supply current, but also 13 to 50 times higher speed.

Protected by U.S. Patent 4,775,884.

TYPICAL APPLICATION

**+90V, -3V Common-Mode Range
 Difference Amplifier ($A_V = 1$)**

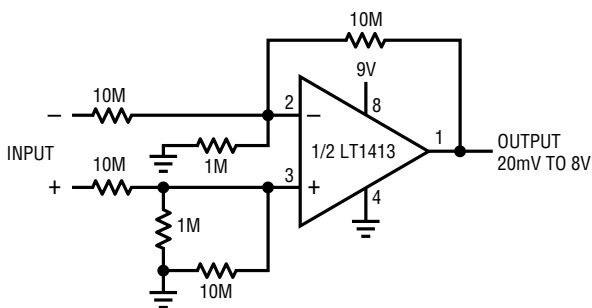

OUTPUT OFFSET = 1.5mV
 (INPUT REFERRED = 125 μ V)
 INPUT RESISTANCE = 11M
 BANDWIDTH = 80kHz

(THE 0.1nA TYPICAL OFFSET CURRENT
 PERMITS THE USE OF 1M Ω RESISTORS)

LT1413 • TA03

**Distribution of Input Offset Voltage
 (In Plastic DIP, N8 Package)**

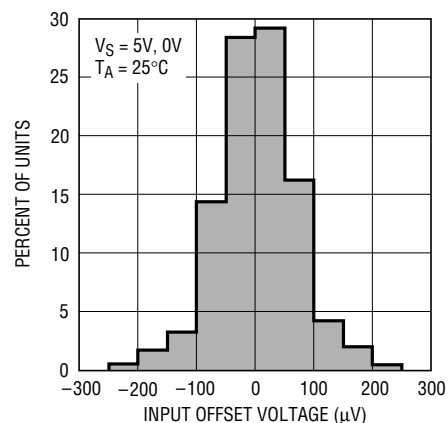

LT1413 • TA01

ABSOLUTE MAXIMUM RATINGS

Supply Voltage $\pm 22V$
 Differential Input Voltage $\pm 30V$
 Input Voltage
 Equal to Positive Supply Voltage
 5V Below Negative Supply Voltage

Output Short-Circuit Duration Indefinite
 Operating Temperature Range $-40^{\circ}C$ to $85^{\circ}C$
 Storage Temperature Range $-65^{\circ}C$ to $150^{\circ}C$
 Lead Temperature (Soldering, 10 sec) $300^{\circ}C$

Note: When the input voltage exceeds the maximum ratings, the input current should be limited to 10mA.

PACKAGE/ORDER INFORMATION

<p>N8 PACKAGE 8-LEAD PLASTIC DIP</p> <p>$T_{JMAX} = 100^{\circ}C, \theta_{JA} = 130^{\circ}C/W$</p>	ORDER PART NUMBER	<p>S8 PACKAGE 8-LEAD PLASTIC SOIC</p> <p>NOTE: THIS PIN CONFIGURATION DIFFERS FROM THE 8-LEAD DIP PIN LOCATIONS. INSTEAD, IT FOLLOWS THE INDUSTRY STANDARD LT1013DS8 SO PACKAGE CONFIGURATION.</p> <p>$T_{JMAX} = 105^{\circ}C, \theta_{JA} = 200^{\circ}C/W$</p>	ORDER PART NUMBER
	LT1413ACN8 LT1413CN8		LT1413S8
			S8 PART MARKING
			1413

ELECTRICAL CHARACTERISTICS $V_S = 5V, 0V, V_{CM} = 0.1V, V_O = 1.4V, T_A = 25^{\circ}C$, unless otherwise noted.

SYMBOL	PARAMETER	CONDITIONS (Note 1)	LT1413ACN8			LT1413CN8/S8			UNITS
			MIN	TYP	MAX	MIN	TYP	MAX	
V_{OS}	Input Offset Voltage	LT1413N8 LT1413S8		50	150		60 80	280 380	μV μV
$\frac{\Delta V_{OS}}{\Delta Time}$	Long-Term Input Offset Voltage Stability			0.4			0.5		$\mu V/Mo$
I_{OS}	Input Offset Current			0.1	0.7		0.1	0.8	nA
I_B	Input Bias Current			9	15		9	18	nA
e_n	Input Noise Voltage	0.1Hz to 10Hz (Note 2)		0.55	1.1		0.55		μV_{p-p}
	Input Noise Voltage Density	$f_0 = 10Hz$ (Note 2) $f_0 = 1000Hz$ (Note 2)		24 23	38 30		24 23		nV/\sqrt{Hz} nV/\sqrt{Hz}
i_n	Input Noise Current	0.1Hz to 10Hz		2.8			2.8		pA_{p-p}
	Input Noise Current Density	$f_0 = 10Hz$ $f_0 = 1000Hz$		0.07 0.02			0.07 0.02		pA/\sqrt{Hz} pA/\sqrt{Hz}
	Input Resistance Differential Mode Common Mode	(Note 3)	300	500 3		250	500 3		$M\Omega$ $G\Omega$
	Input Voltage Range		3.65 0	3.8 -0.3		3.65 0	3.8 -0.3		V V
CMRR	Common-Mode Rejection Ratio	$V_{CM} = 0V$ to $3.65V$	90	101		88	101		dB
PSRR	Power Supply Rejection Ratio	$V_S = 3.2V$ to $12V$	102	118		100	118		dB
A_{VOL}	Large-Signal Voltage Gain	$V_O = 0.05V$ to $4V$, No Load	400	1400		350	1400		V/mV
		$V_O = 0.05V$ to $3.5V, R_L = 2k$	300	1000		250	1000		V/mV

ELECTRICAL CHARACTERISTICS $V_S = 5V, 0V, V_{CM} = 0.1V, V_O = 1.4V, T_A = 25^\circ C$, unless otherwise noted.

SYMBOL	PARAMETER	CONDITIONS	LT1413ACN8			LT1413CN8/S8			UNITS	
			MIN	TYP	MAX	MIN	TYP	MAX		
	Maximum Output Voltage Swing	Output Low, No Load		15	25		15	25	mV	
		Output Low, 600Ω to GND		5	10		5	10	mV	
		Output Low, $I_{SINK} = 1mA$			220	350		220	350	mV
		Output High, No Load	4.1	4.4		4.1	4.4		V	
		Output High, 600Ω to GND	3.4	4.0		3.4	4.0		V	
SR	Slew Rate	$A_V = 1$	0.2	0.3		0.2	0.3		V/μs	
GBW	Gain-Bandwidth Product	$f_0 \leq 100kHz$ (Note 4)	600	950		600	950		kHz	
I_S	Supply Current per Amplifier			330	450		330	480	μA	
	Channel Separation	$\Delta V_{IN} = 3V, R_L = 2k$ (Note 5)	125	140		123	140		dB	
	Minimum Supply Voltage	(Note 6)		2.85	3.0		2.85	3.0	V	

$V_S = 5V, 0V, V_{CM} = 0.1V, V_O = 1.4V, 0^\circ C \leq T_A \leq 70^\circ C$, unless otherwise noted.

SYMBOL	PARAMETER	CONDITIONS (Note 1)	LT1413ACN8			LT1413CN8/S8			UNITS	
			MIN	TYP	MAX	MIN	TYP	MAX		
V_{OS}	Input Offset Voltage	LT1413N8	●	65	240		80	390	μV	
		LT1413S8	●				100	490	μV	
$\Delta V_{OS}/\Delta T$	Input Offset Voltage Drift	(Note 5)	●	0.3	2.0		0.4	2.5	μV/°C	
I_{OS}	Input Offset Current		●	0.1	1.0		0.1	1.2	nA	
I_B	Input Bias Current		●	10	20		10	23	nA	
CMRR	Common-Mode Rejection Ratio	$V_{CM} = 0V$ to 3.6V	●	88	100		85	100	dB	
PSRR	Power Supply Rejection Ratio	$V_S = 3.45V$ to 12V	●	100	117		97	117	dB	
A_{VOL}	Large-Signal Voltage Gain	$V_O = 0.07V$ to 3.9V, No Load	●	300	1100		300	1100	V/mV	
		$V_O = 0.07V$ to 3.2V, $R_L = 2k$	●	200	800		200	800	V/mV	
	Maximum Output Voltage Swing	Output Low, No Load	●		18	32		18	32	mV
		Output Low, $I_{SINK} = 1mA$	●		270	430		270	430	mV
		Output High, No Load	●	4.0	4.3		4.0	4.3		V
		Output High, 600Ω to GND	●	3.3	3.9		3.2	3.9		V
I_S	Supply Current per Amplifier		●	350	500		350	530	μA	

$V_S = 5V, 0V, V_{CM} = 0.1V, V_O = 1.4V, -40^\circ C \leq T_A \leq 85^\circ C$ (Note 7)

SYMBOL	PARAMETER	CONDITIONS (Note 1)	LT1413ACN8			LT1413CN8/S8			UNITS	
			MIN	TYP	MAX	MIN	TYP	MAX		
V_{OS}	Input Offset Voltage	LT1413N8	●	70	300		85	470	μV	
		LT1413S8	●				110	570	μV	
$\Delta V_{OS}/\Delta T$	Input Offset Voltage Drift		●	0.3	2.2		0.4	2.8	μV/°C	
I_{OS}	Input Offset Current		●	0.2	1.4		0.2	1.7	nA	
I_B	Input Bias Current		●	11	25		11	30	nA	
CMRR	Common-Mode Rejection Ratio	$V_{CM} = 0V$ to 3.4V	●	85	99		82	99	dB	
PSRR	Power Supply Rejection Ratio	$V_S = 3.9V$ to 12V	●	98	116		94	116	dB	
A_{VOL}	Large-Signal Voltage Gain	$V_O = 0.08V$ to 3.8V, No Load	●	220	1000		220	1000	V/mV	
		$V_O = 0.08V$ to 3.0V, $R_L = 2k$	●	150	700		150	700	V/mV	
	Maximum Output Voltage Swing	Output Low, No Load	●		20	38		20	38	mV
		Output Low, $I_{SINK} = 1mA$	●		300	480		300	480	mV
		Output High, No Load	●	3.9	4.2		3.9	4.2		V
		Output High, 600Ω to GND	●	3.1	3.8		3.0	3.8		V
I_S	Supply Current per Amplifier		●	360	550		360	580	μA	

ELECTRICAL CHARACTERISTICS $V_S = \pm 15V$, $T_A = 25^\circ C$, unless otherwise noted.

SYMBOL	PARAMETER	CONDITIONS (Note 1)	LT1413ACN8			LT1413CN8/S8			UNITS
			MIN	TYP	MAX	MIN	TYP	MAX	
V_{OS}	Input Offset Voltage	LT1413N8 LT1413S8		75	280		90 110	480 580	μV μV
I_{OS}	Input Offset Current			0.1	0.7		0.1	0.8	nA
I_B	Input Bias Current			8	15		8	18	nA
	Input Voltage Range		13.5 -15.0	13.8 -15.3		13.5 -15.0	13.8 -15.3		V V
CMRR	Common-Mode Rejection Ratio	$V_{CM} = 13.5V, -15V$		100	117		97	114	dB
PSRR	Power Supply Rejection Ratio	$V_S = \pm 2V$ to $\pm 18V$		103	120		100	117	dB
A_{VOL}	Large-Signal Voltage Gain	$V_O = \pm 10V, R_L = 2k$		1500	5000		1200	4000	V/mV
V_{OUT}	Maximum Output Voltage Swing	$R_L = 2k$		± 13	± 14		± 12.5	± 14	V
SR	Slew Rate			0.2	0.4		0.2	0.4	V/ μs
I_S	Supply Current per Amplifier			350	500		350	550	μA

$V_S = \pm 15V$, $0^\circ C \leq T_A \leq 70^\circ C$, unless otherwise noted.

SYMBOL	PARAMETER	CONDITIONS (Note 1)	LT1413ACN8			LT1413CN8/S8			UNITS
			MIN	TYP	MAX	MIN	TYP	MAX	
V_{OS}	Input Offset Voltage	LT1413N8 LT1413S8		95	390		110 130	620 720	μV μV
$\Delta V_{OS}/\Delta T$	Input Offset Voltage Drift	(Note 5)		0.4	2.5		0.5	3.0	$\mu V/^\circ C$
I_{OS}	Input Offset Current			0.1	1.0		0.1	1.2	nA
I_B	Input Bias Current			9	20		9	23	nA
A_{VOL}	Large-Signal Voltage Gain	$V_O = \pm 10V, R_L = 2k$		1000	4000		700	3000	V/mV
CMRR	Common-Mode Rejection Ratio	$V_{CM} = 13V, -15V$		98	116		94	113	dB
PSRR	Power Supply Rejection Ratio	$V_S = \pm 2V$ to $\pm 18V$		101	119		97	116	dB
	Maximum Output Voltage Swing	$R_L = 2k$		± 12.5	± 13.9		± 12.0	± 13.9	V
I_S	Supply Current per Amplifier			360	550		360	600	μA

$V_S = \pm 15V$, $-40^\circ C \leq T_A \leq 85^\circ C$ (Note 7)

SYMBOL	PARAMETER	CONDITIONS (Note 1)	LT1413ACN8			LT1413CN8/S8			UNITS
			MIN	TYP	MAX	MIN	TYP	MAX	
V_{OS}	Input Offset Voltage	LT1413N8 LT1413S8		100	460		120 140	700 800	μV μV
$\Delta V_{OS}/\Delta T$	Input Offset Voltage Drift			0.4	2.8		0.5	3.3	$\mu V/^\circ C$
I_{OS}	Input Offset Current			0.2	1.4		0.2	1.7	nA
I_B	Input Bias Current			10	25		10	30	nA
A_{VOL}	Large-Signal Voltage Gain	$V_O = \pm 10V, R_L = 2k$		800	3000		500	2400	V/mV
CMRR	Common-Mode Rejection Ratio	$V_{CM} = 13V, -15V$		97	115		92	112	dB
PSRR	Power Supply Rejection Ratio	$V_S \pm 2V$ to $\pm 18V$		100	118		95	115	dB
	Maximum Output Voltage Swing	$R_L = 2k$		± 12.2	± 13.8		± 11.8	± 13.8	V
I_S	Supply Current per Amplifier			370	580		370	630	μA

The ● denotes specifications which apply over the full operating temperature range.

Note 1: Typical parameters are defined as the 60% yield of parameter distributions of individual amplifiers; i.e., out of 100 LT1413s typically 120 op amps will be better than the indicated specification.

Note 2: This parameter is tested on a sample basis only. All noise parameters are tested with $V_S = \pm 2.5V$, $V_O = 0V$.

Note 3: This parameter is guaranteed by design and is not tested.

Note 4: Gain-Bandwidth Product is not tested. It is inferred from the slew rate measurement.

Note 5: This parameter is not 100% tested.

Note 6: At the minimum supply voltage, the offset voltage changes less than 200 μV compared to its value at 5V, 0V.

Note 7: The LT1413 is not tested and is not quality-assurance sampled at $-40^\circ C$ and at $85^\circ C$. These specifications are guaranteed by design, correlation and/or inference from $0^\circ C$, $25^\circ C$ and/or $70^\circ C$ tests.

TYPICAL PERFORMANCE CHARACTERISTICS

Distribution of Input Offset Voltage (In S8 Package)

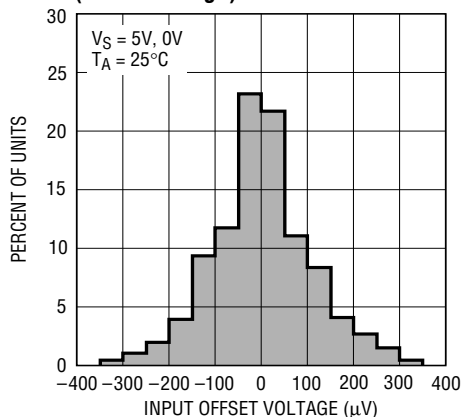

LT1413 • TA02

Supply Current vs Temperature

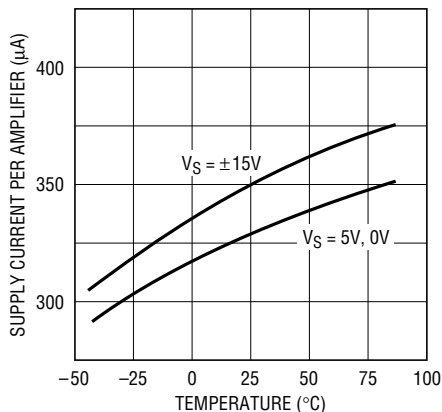

LT1413 • TA04

Output Saturation vs Sink Current vs Temperature

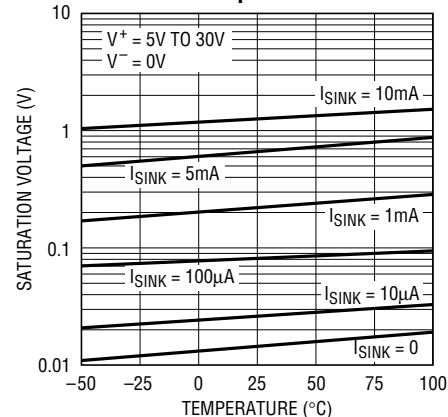

LT1413 • TA05

Input Offset Current vs Temperature

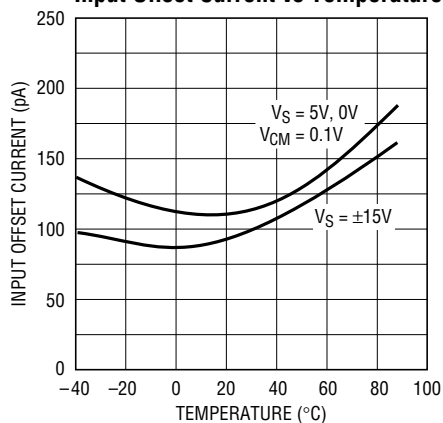

LT1413 • TA06

Input Bias Current vs Temperature

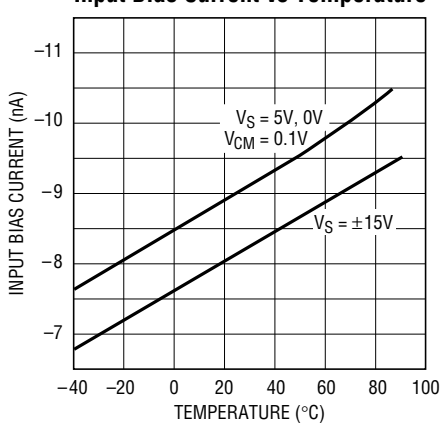

LT1413 • TA07

Input Bias Current vs Common-Mode Voltage

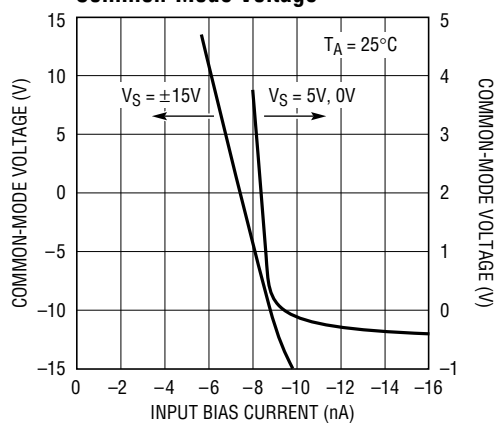

LT1413 • TA08

0.1Hz to 10Hz Noise

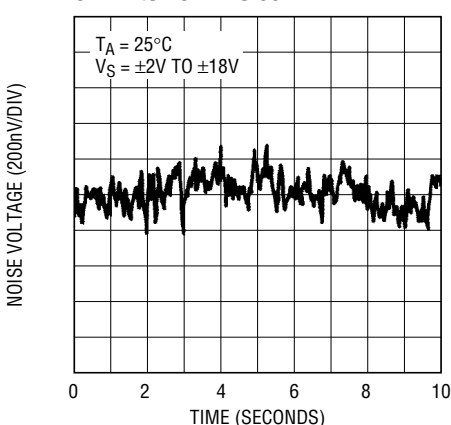

LT1413 • TA09

Noise Spectrum

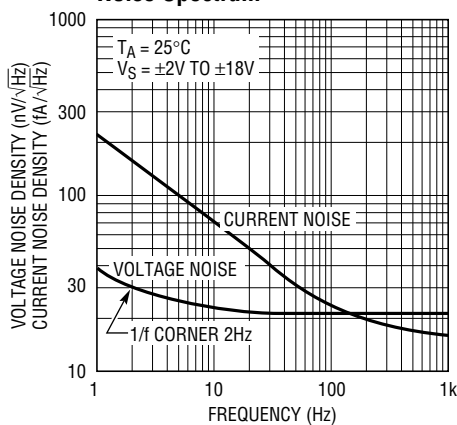

LT1413 • TA10

Minimum Supply Voltage

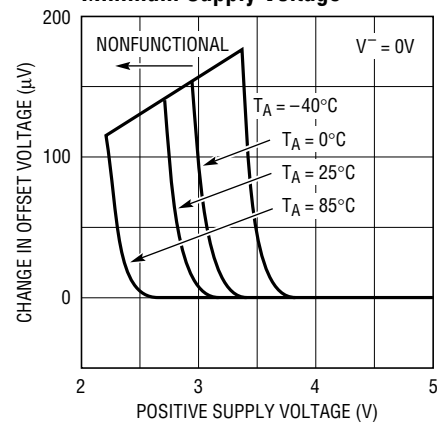

LT1413 • TA11

TYPICAL PERFORMANCE CHARACTERISTICS

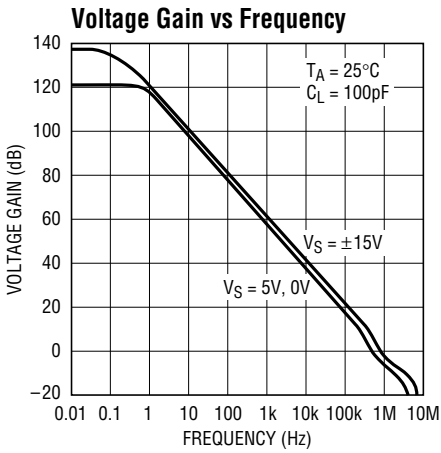

LT1413 • TA12

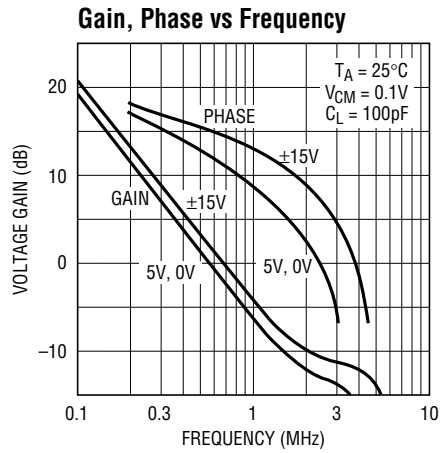

LT1413 • TA13

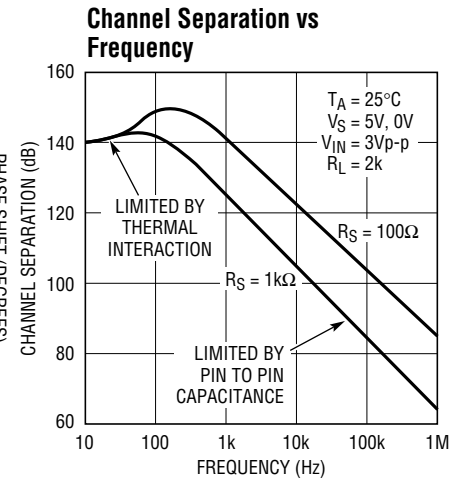

LT1413 • TA14

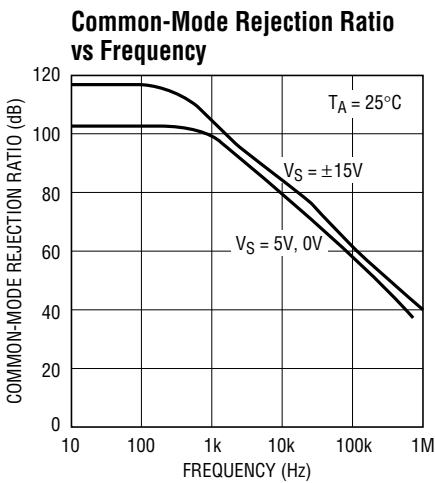

LT1413 • TA15

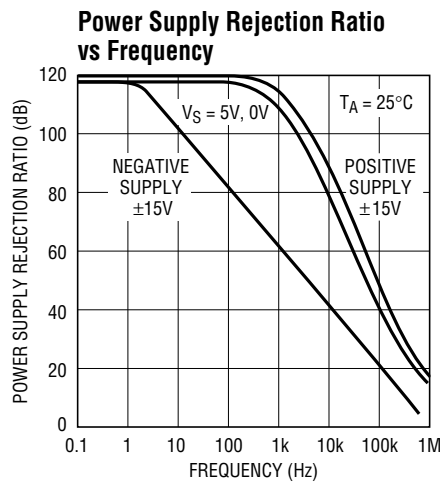

LT1413 • TA16

Small Signal Transient Response, $V_S = \pm 15\text{V}$

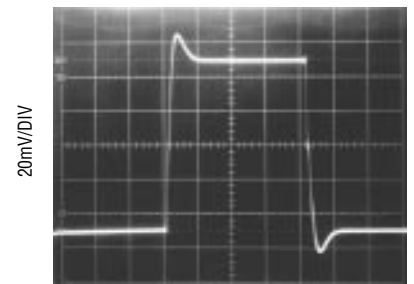

LT1413 • TA17

Small Signal Transient Response, $V_S = 5\text{V}, 0\text{V}$

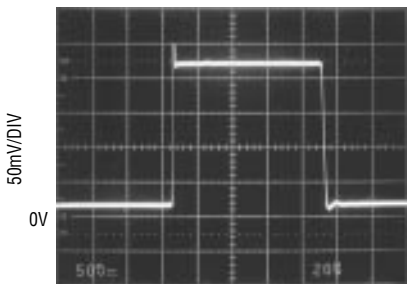

LT1413 • TA18

Large Signal Transient Response, $V_S = 5\text{V}, 0\text{V}$

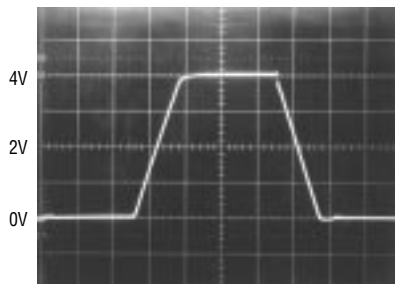

LT1413 • TA19

Large Signal Transient Response, $V_S = \pm 15\text{V}$

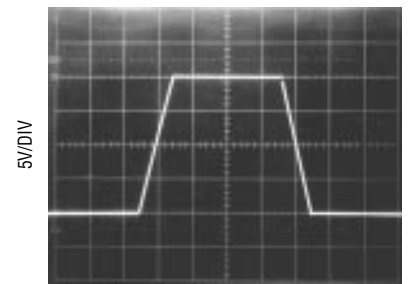

LT1413 • TA20

APPLICATIONS INFORMATION

Single Supply Operation

The LT1413 is fully specified for single supply operation, i.e., when the negative supply is 0V. Input common-mode range includes ground; the output swings within a few millivolts of ground.

If the input is more than a few hundred millivolts below ground, two distinct problems can occur on previous single supply designs, such as the LM124, LM158, OP-21 and OP-221.

a) When the input is more than a diode drop below ground, unlimited current will flow from the substrate (V^- terminal) to the input. This can destroy the unit. On the LT1413, the 400Ω resistors, in series with the input (see Schematic Diagram), protect the devices even when the input is 5V below ground.

b) When the input is more than 400mV below ground (at 25°C), the input stage saturates (transistors Q3 and Q4) and phase reversal occurs at the output. This can cause lock-up in servo systems. Due to a unique phase reversal protection circuitry (Q21, Q22, Q27, Q28), the LT1413 outputs do not reverse, as illustrated below, even when the inputs are at $-1.5V$. Keep the output of the

other amplifier out of negative saturation for the phase reversal protection to function properly.

Since the output of the LT1413 cannot go exactly to ground, but can only approach ground to within a few millivolts, care should be exercised to ensure that the output is not saturated. For example, a 1mV input signal will cause the amplifier to set up in its linear region in the gain 100 configuration shown below, but is not enough to make the amplifier function properly in the voltage-follower mode.

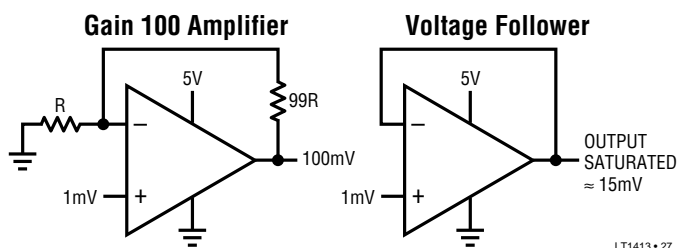
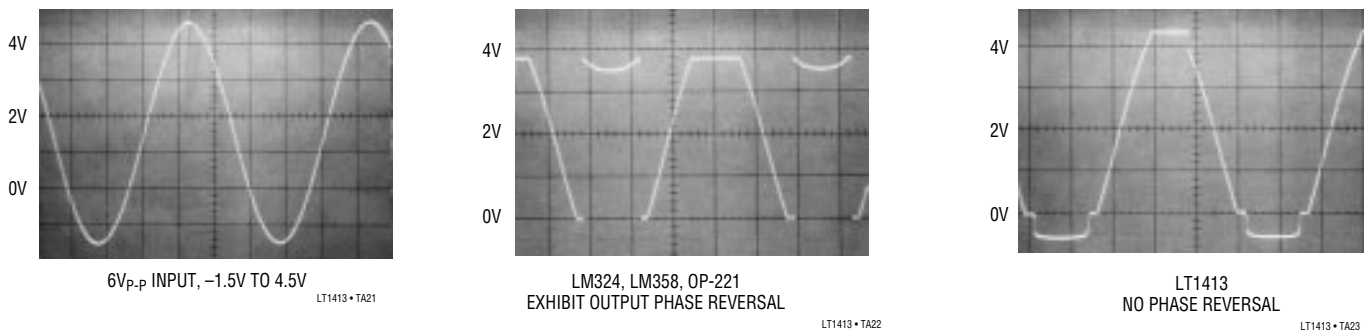

Figure 1.

Comparator Applications

The single supply operation of the LT1413 lends itself to its use as a precision comparator with TTL compatible output; the response time is shown below.

Voltage Follower with Input Exceeding the Negative Common-Mode Range



Comparator Rise Response Time 10mV, 5mV, 2mV Overdrives

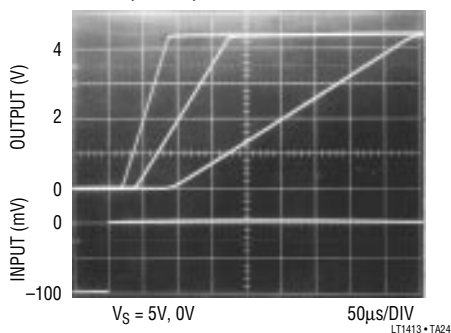

Comparator Fall Response Time to 10mV, 5mV, 2mV Overdrives

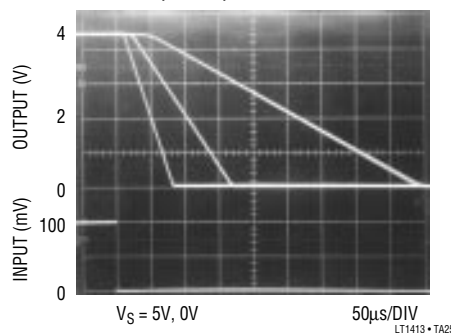

SIMPLIFIED SCHEMATIC

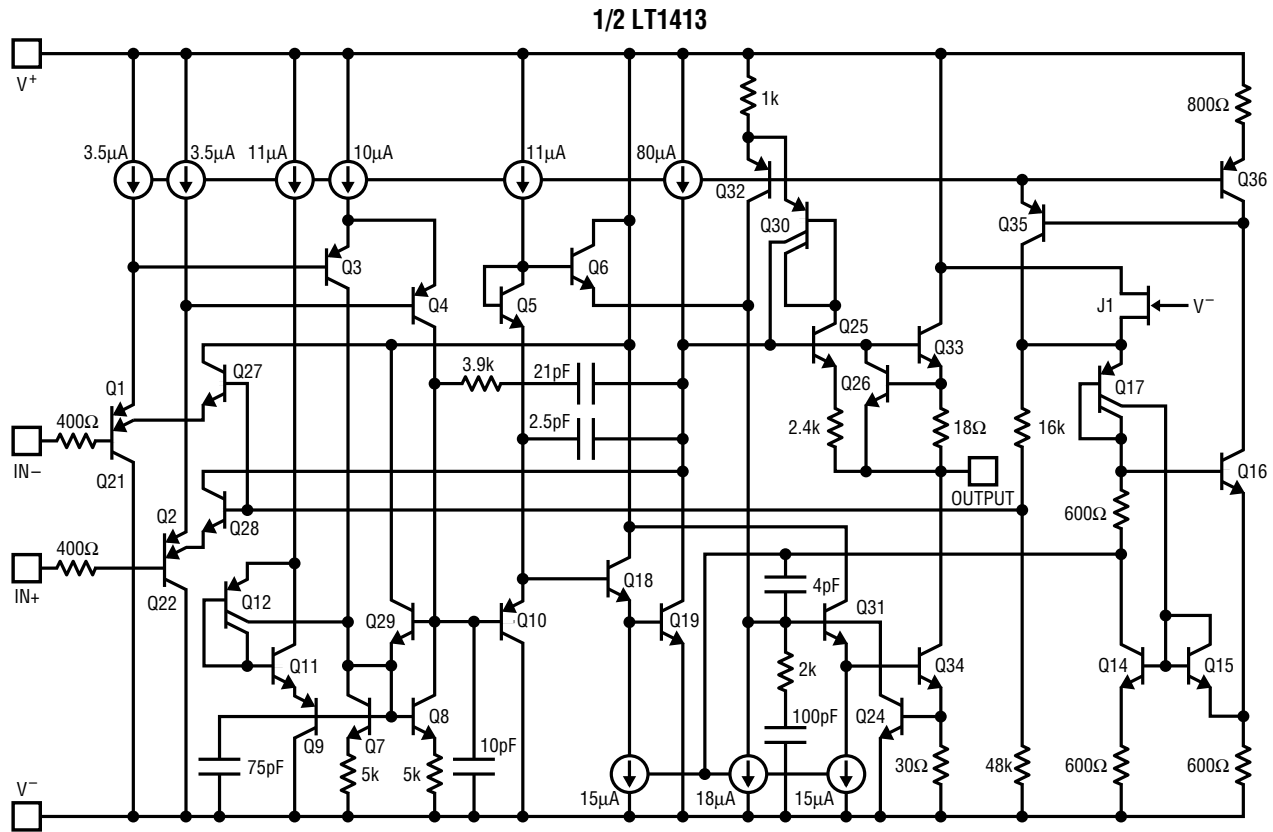

LT1413 • TA26

PACKAGE DESCRIPTION

N8 Package, 8-Lead Plastic DIP

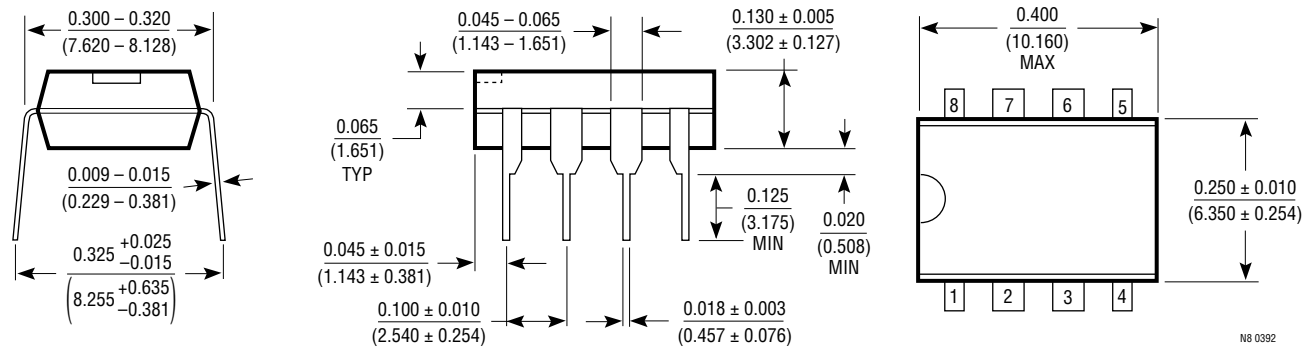

N8 0392

S8 Package, 8-Lead Plastic SOIC

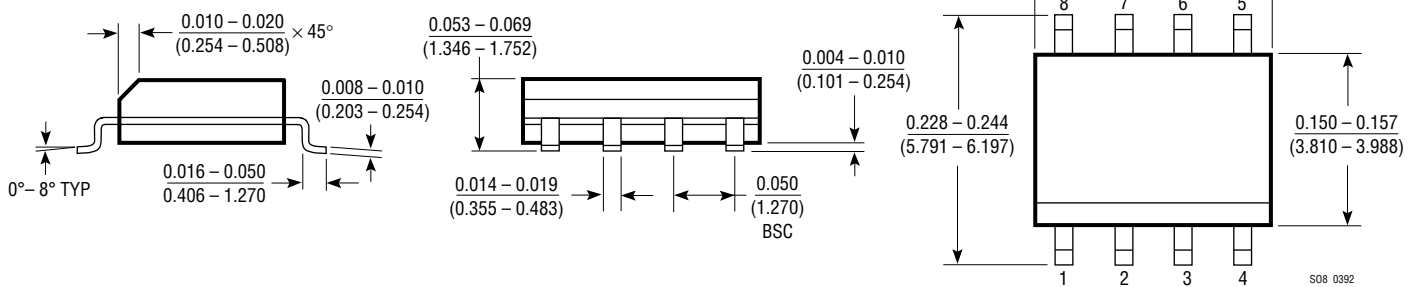

S08 0392