

GaAs MMIC SMT DOUBLE-BALANCED MIXER, 1.5 - 4.5 GHz



Typical Applications

The HMC213AMS8(E) is ideal for:

- Base Stations
- PCMCIA Transceivers
- Wireless Local Loop

Features

- Ultra Small Package: MSOP8
- Conversion Loss: 8.5 dB
- LO / RF Isolation: 40 dB

Functional Diagram

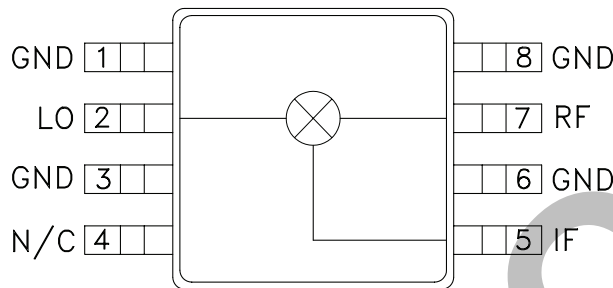

General Description

The HMC213AMS8(E) is an ultra miniature double-balanced mixer in 8 lead plastic surface mount package (MSOP). This passive MMIC mixer is constructed of GaAs Schottky diodes and novel planar transformer baluns on the chip. The device can be used as an upconverter, downconverter, biphase (de)modulator, or phase comparator. The consistent MMIC performance will improve system operation and assure regulatory compliance.

Electrical Specifications, $T_A = +25^\circ\text{C}$, As a Function of LO Drive

Parameter	LO = +13 dBm IF = 100 MHz			LO = +10 dBm IF = 100 MHz			Units
	Min.	Typ.	Max.	Min.	Typ.	Max.	
Frequency Range, RF & LO	1.5 - 4.5			1.7 - 3.6			GHz
Frequency Range, IF	DC - 1.5			DC - 1.5			GHz
Conversion Loss		8.5	10		9	10.5	dB
Noise Figure (SSB)		8.5	10		9	10.5	dB
LO to RF Isolation	29	40		32	40		dB
LO to IF Isolation	27	35		26	35		dB
IP3 (Input)	16	19		14	18		dBm
1 dB Gain Compression (Input)	7	10		5	8		dBm

Information furnished by Analog Devices is believed to be accurate and reliable. However, no responsibility is assumed by Analog Devices for its use, nor for any infringements of patents or other rights of third parties that may result from its use. Specifications subject to change without notice. No license is granted by implication or otherwise under any patent or patent rights of Analog Devices. Trademarks and registered trademarks are the property of their respective owners.

For price, delivery, and to place orders: Analog Devices, Inc., One Technology Way, P.O. Box 9106, Norwood, MA 02062-9106
Phone: 781-329-4700 • Order online at www.analog.com
Application Support: Phone: 1-800-ANALOG-D



GaAs MMIC SMT DOUBLE-BALANCED MIXER, 1.5 - 4.5 GHz

Conversion Gain vs. Temperature @ LO = +13 dBm

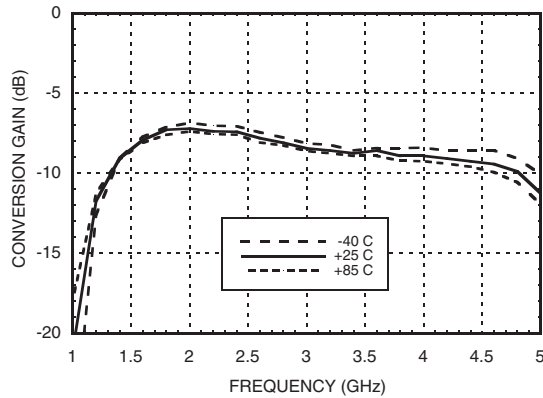

Isolation @ LO = +13 dBm

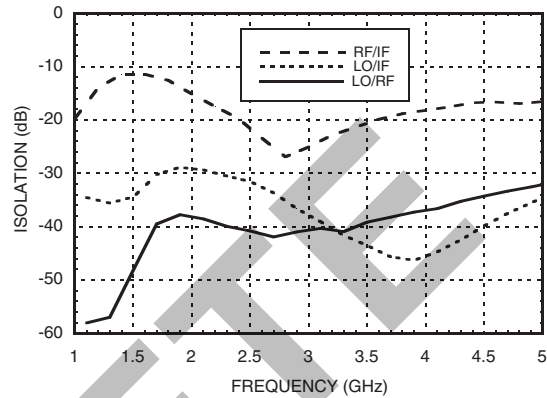

Conversion Gain vs. LO Drive

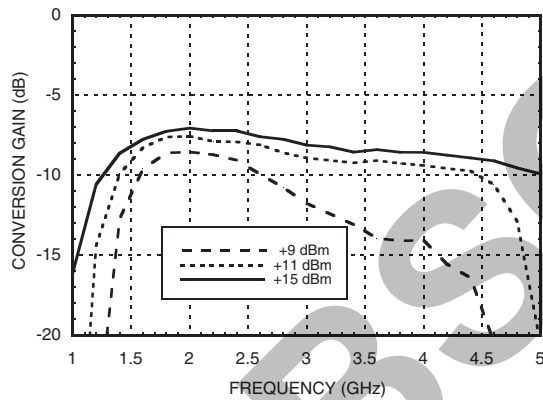

Return Loss @ LO = +13 dBm

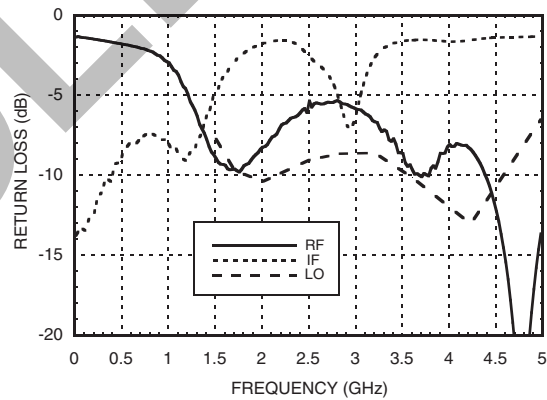

IF Bandwidth @ LO = +13 dBm

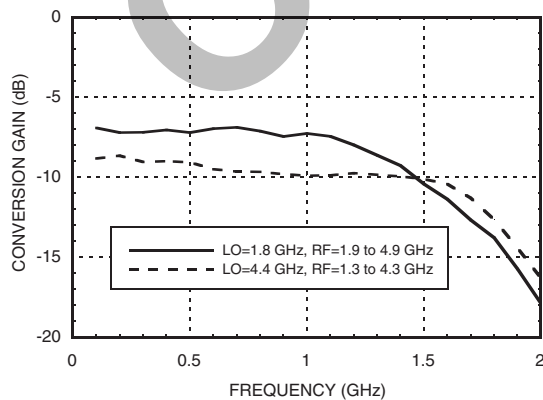

P1dB vs. Temperature @ LO = +13 dBm

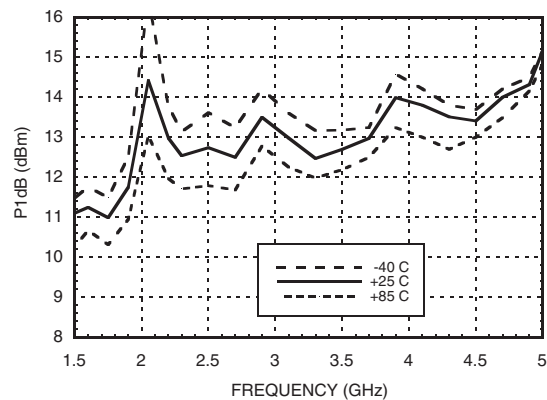

Information furnished by Analog Devices is believed to be accurate and reliable. However, no responsibility is assumed by Analog Devices for its use, nor for any infringements of patents or other rights of third parties that may result from its use. Specifications subject to change without notice. No license is granted by implication or otherwise under any patent or patent rights of Analog Devices. Trademarks and registered trademarks are the property of their respective owners.

For price, delivery, and to place orders: Analog Devices, Inc., One Technology Way, P.O. Box 9106, Norwood, MA 02062-9106 Phone: 781-329-4700 • Order online at www.analog.com Application Support: Phone: 1-800-ANALOG-D



GaAs MMIC SMT DOUBLE-BALANCED MIXER, 1.5 - 4.5 GHz

Input IP3 vs. LO Drive

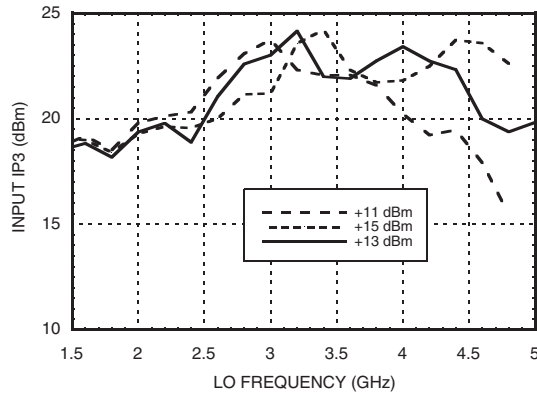

Input IP3 vs. Temperature @ LO = +13 dBm

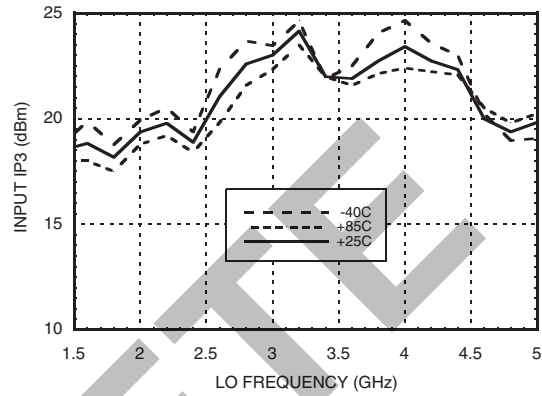

Input IP2 vs. LO Drive

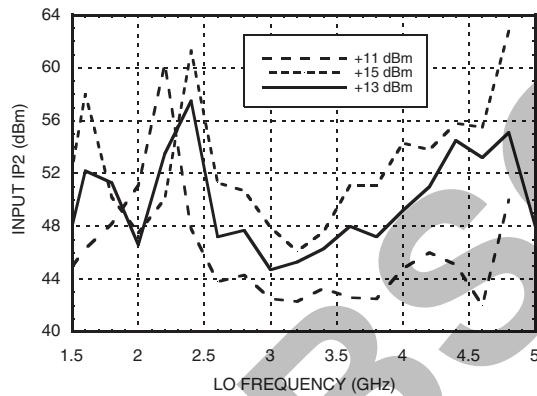

Input IP2 vs. Temperature @ LO = +13 dBm

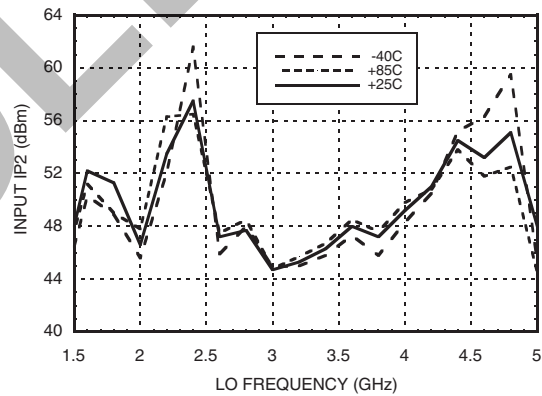

Information furnished by Analog Devices is believed to be accurate and reliable. However, no responsibility is assumed by Analog Devices for its use, nor for any infringements of patents or other rights of third parties that may result from its use. Specifications subject to change without notice. No license is granted by implication or otherwise under any patent or patent rights of Analog Devices. Trademarks and registered trademarks are the property of their respective owners.

For price, delivery, and to place orders: Analog Devices, Inc., One Technology Way, P.O. Box 9106, Norwood, MA 02062-9106 Phone: 781-329-4700 • Order online at www.analog.com Application Support: Phone: 1-800-ANALOG-D



GaAs MMIC SMT DOUBLE-BALANCED MIXER, 1.5 - 4.5 GHz

MxN Spurious Outputs

mRF	nLO				
	0	1	2	3	4
0	xx	12.7	20.8	19.8	76.2
1	13.4	0	39.8	38.9	56.2
2	73.8	78.2	66.5	82.2	68.8
3	93.8	89.2	92.2	82.4	89.0
4	>105	>105	>105	>105	>105

RF = 3.5 GHz @ -10 dBm
 LO = 3.6 GHz @ +13 dBm
 All values in dBc below IF power level (-1RF + 1LO)

Harmonics of LO @ RF Port

LO Freq. (GHz)	nLO Spur			
	1	2	3	4
1.5	40	30	62	57
2.0	38	25	55	58
2.5	41	28	34	61
3.0	41	35	36	61
3.5	38	45	52	62
4.0	35	47	55	62
4.5	33	50	65	73
5.0	32	52	68	82

LO = +13 dBm
 Values in dBc below input LO level measured at RF Port.

Absolute Maximum Ratings

RF / IF Input	+13 dBm
LO Drive	+27 dBm
Continuous Pdiss (T = 85 °C) (derate 10.6 mW/°C above 85 °C)	0.69 W
Thermal Resistance (Channel to package lead)	93.7 °C/W
Junction Temperature	150 °C
Storage Temperature	-65 to +150 °C
Operating Temperature	-40 to +85 °C



ELECTROSTATIC SENSITIVE DEVICE
 OBSERVE HANDLING PRECAUTIONS



GaAs MMIC SMT DOUBLE-BALANCED MIXER, 1.5 - 4.5 GHz

Outline Drawing

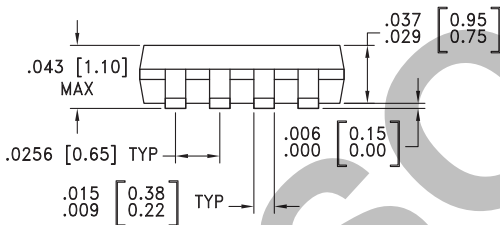
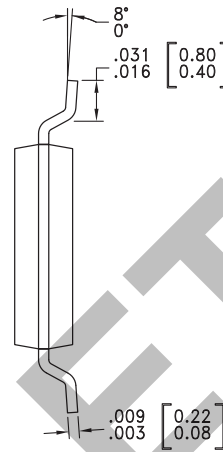
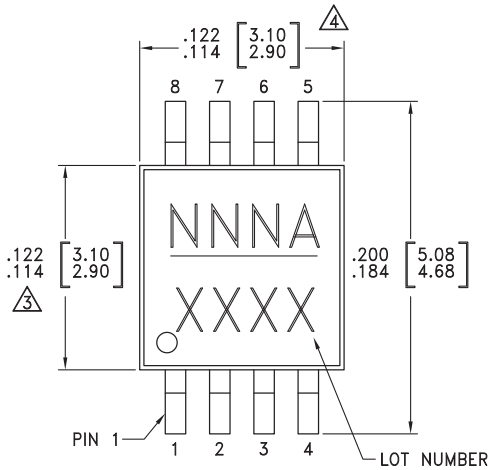

NOTES:

1. LEADFRAME MATERIAL: COPPER ALLOY
2. DIMENSIONS ARE IN INCHES [MILLIMETERS].
3. DIMENSION DOES NOT INCLUDE MOLDFLASH OF 0.15mm PER SIDE.
4. DIMENSION DOES NOT INCLUDE MOLDFLASH OF 0.25mm PER SIDE.
5. ALL GROUND LEADS MUST BE SOLDERED TO PCB RF GROUND.

Package Information

Part Number	Package Body Material	Lead Finish	MSL Rating	Package Marking ^[3]
HMC213AMS8	Low Stress Injection Molded Plastic	Sn/Pb Solder	MSL1 ^[1]	213A XXXX
HMC213AMS8E	RoHS-compliant Low Stress Injection Molded Plastic	100% matte Sn	MSL1 ^[2]	213A XXXX

[1] Max peak reflow temperature of 235 °C
 [2] Max peak reflow temperature of 260 °C
 [3] 4-Digit lot number XXXX



Evaluation PCB

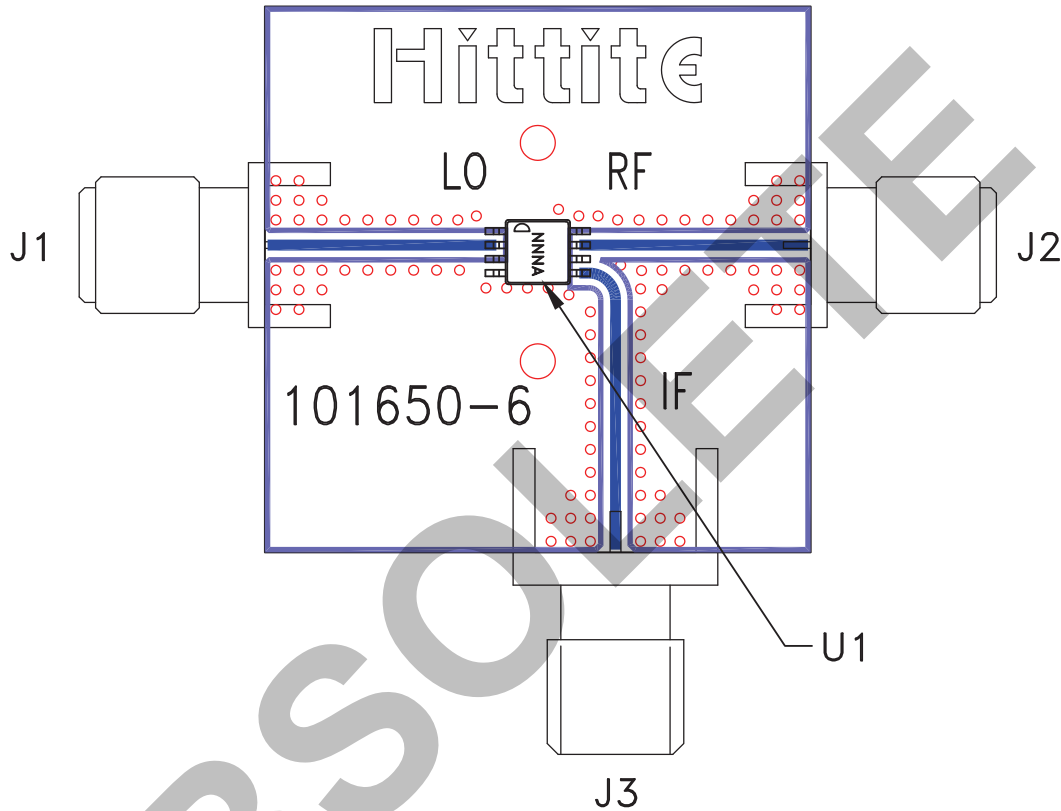

List of Materials for Evaluation PCB 103350 [1]

Item	Description
J1 - J3	PCB Mount SMA RF Connector
U1	HMC213AMS8(E) Mixer
PCB [2]	101650 Evaluation Board

[1] Reference this number when ordering complete evaluation PCB

[2] Circuit Board Material: Rogers 4350

The circuit board used in the application should use RF circuit design techniques. Signal lines should have 50 Ohm impedance while the package ground leads and exposed paddle should be connected directly to the ground plane similar to that shown. A sufficient number of via holes should be used to connect the top and bottom ground planes. The evaluation circuit board shown is available from Hittite upon request.