

FEATURES

- Industry's first loop-powered meter with a large, easy-to-read, LED display!
- Self-powered, no external supply required
- Unipolar, Bipolar and Positive Reading Models
- Large, 0.37"/9.4mm digits
- Excellent display intensity
- High-quality, 20-turn, span (gain) and zero (offset) adjustments
- DIP-switch selectable range and decimal points
- Hundreds of input/readout combinations
- Vibration-resistant package; Reliable screw-terminal input connections

The DMS-20PC-4/20 Series are the world's first loop-powered digital panel meters with a large, easy-to-read, bright red, LED display. All operating power is derived directly from the loop current itself—no external power supply is required! The large, 0.37"/9.4mm digits exhibit uniform intensity over the entire 4-20mA operating range. Additionally, the total maximum loop voltage drop is only 5V! Users no longer have to settle for difficult-to-read LCD displays in loop-powered applications.

Both gain (span) and offset (zero) adjustments are performed with on-board, precision, 20-turn potentiometers. All decimal-point and range-change selections are made on a six-position DIP switch featuring vibration-resistant, gold-plated contacts. Unlike competitive meters, there are no jumpers or solder gaps to open or close. Connections to the current loop are made via a reliable, two-position, screw-type terminal block.

The DMS-20PC-4/20's DIP switch and adjustment potentiometers accommodate hundreds of different input-current/output-reading combinations. This versatility practically eliminates the need to order more costly, long-lead-time, factory-customized "specials" in applications in which several different-range meters are required. An optional bezel assembly, featuring screw fasteners and a rubber seal, simplifies panel mounting and provides excellent resistance to environmental dust and moisture. All these outstanding features combine to make the DMS-20PC-4/20 Series the perfect meters for prototype and OEM 4-20mA current-loop instrumentation.

SIMPLIFIED SCHEMATIC DIAGRAM

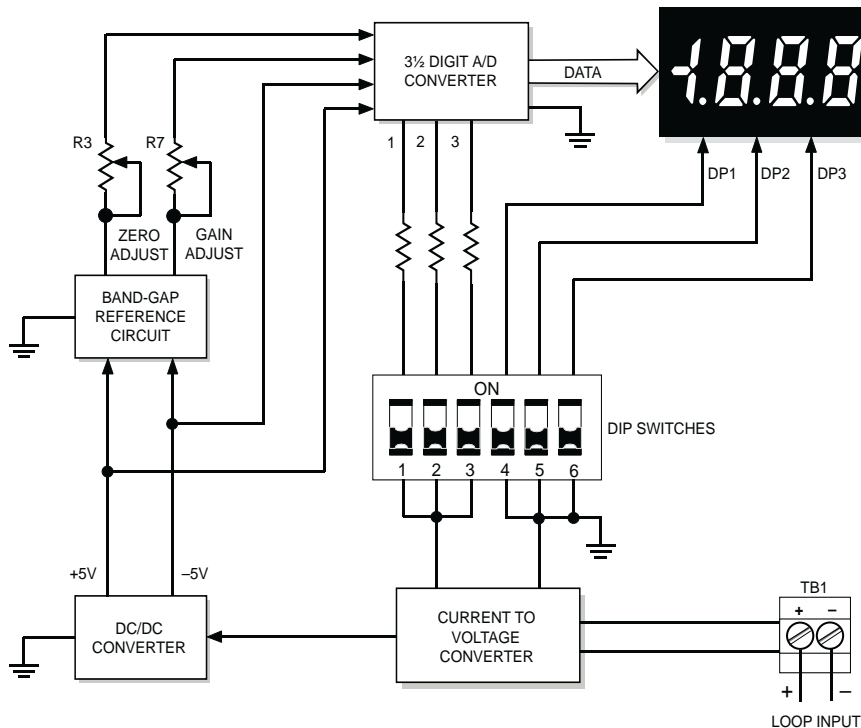

Performance/Functional Specifications

Typical at T_A = +25°C, unless otherwise noted.

Current Loop Input	Min.	Typ.	Max.	Units
Full Scale Input Range: ①	+4	–	+20	mA
Input Impedance: ②	–	250		Ω
Voltage Drop ②	–	4.5	5.0	Volts
Overcurrent Protection ①	–	–	±40	mA
Performance				
Sampling Rate	2.5 reading per second			
Accuracy (1 minute warm-up):	±0.05%FS ±1 Count			
Temperature Drift (0 to +60°C)	–	±0.15	±0.3	Cnts/°C
Display				
Display Type and Size	3½ digit, 0.37"/9.4mm high red LED			
Polarity Indication	"–" for negative reading			
Overrange Indication	"–1____" for negative Vin "1____" for positive Vin			
Physical/Environmental				
Operating Temperature	0	–	+60	°C
Storage Temperature	–40	–	+75	°C
Humidity (non-condensing)	0	–	95	%
Case Material	Polycarbonate			
Weight	0.6 ounces (17 grams)			

① The DMS-20PC-4/20, using any of the DIP-switch settings described above, can withstand overcurrents, including those resulting from accidental reverse-polarity connections, up to ±40mA without sustaining any damage.

② Because Murata Power Solutions' DMS-4/20 loop-powered meters employ active circuitry to convert the loop current into a voltage, the meters' effective series impedance varies in a manner that maintains the loop voltage drop constant over the full 4-to-20mA current range. Listed impedance specification applies at 20mA.

③ When looking up DIP-switch settings in the Tables and the desired display readings can be achieved with either of two different settings, using the higher setting # will produce less sensitive offset (R3) and span (R7) adjustments. Please keep in mind that the DMS-20PC standard meter (from which the DMS-20PC-4/20 is derived) has an accuracy specification of ±2 counts (max.). Thus, it may not always be possible to obtain the exact desired display reading.

Ordering Information

DMS-20PC-4/20S-C	Unipolar reading, loop-powered LED meter
DMS-20PC-4/20B-C	Bipolar reading, loop-powered LED meter
DMS-20PC-4/20P-C	Positive reading, loop-powered LED meter
DMS-BZL3-C	Bezel assembly
DMS-BZL4-C	Bezel assembly with sealing gasket
DMS-20-CP	Panel cutout punch

A panel-mount retaining clip is supplied with each model.



OPERATING AND SETUP INSTRUCTIONS

DMS-20PC-4/20S (Unipolar Reading Model)

As shipped, the DMS-20PC-4/20S is factory calibrated to read "000" for a 4mA input and "1000" for a 20mA input. The following worst-case procedure assumes the DMS-20PC-4/20S is completely mis-adjusted, i.e., both potentiometers and the DIP switches are randomly set. When performing DIP-switch settings, be sure the DIP switch's small actuators are firmly engaged in their fully-ON or fully-OFF positions.

1. Set R7 (full scale span/gain adjust) and R3 (zero/offset adjust) fully clockwise, roughly 22 turns, and place SW1-SW6 to OFF.
2. Select DIP switch setting #2.
3. Apply a precision 4mA input, with proper polarity, and adjust R3 until the meter's display reads "000".
4. Apply a precision 20mA input and adjust R7 until the meter's display reads "1000". Repeat steps 3 and 4 to make sure the adjustments do not affect one another.
5. Select the appropriate decimal point by setting SW4, SW5 or SW6 to ON (DP1, DP2 or DP3 respectively).

NOTE: If a display reading other than "000" to "1000" is desired, refer to DIP-Switch Settings Table 1 for SW1-SW3 settings.

Table 1. DMS-20PC-4/20S (Unipolar Model) DIP-Switch Settings

Display Reading	SW1	SW2	SW3
4mA 20mA			
1. 000 to 1050-1999	Off	Off	Off
2. 000 to 650-1350	On	Off	Off
3. 000 to 450-800	Off	On	Off
4. 000 to 300-500	Off	Off	On
5. 000 to 200-300	On	On	On

Examples (DMS-20PC-4/20S-Unipolar Model)

1. Desired display readings are:

4mA = "0.00"
20mA = "6.00"



Use DIP-switch setting #3 in Table 1 and enable decimal point DP2 via SW5. Apply 4mA and adjust R3 so the display reads "0.00". Apply 20mA and adjust R7 so the display reads "6.00".

2. Desired display readings are:

4mA = "000"
20mA = "800"

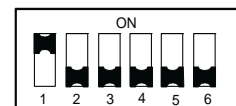

Use DIP-switch setting #2 in Table 1. Apply 4mA and adjust R3 so the display reads "000". Apply 20mA and adjust R7 so the display reads "800". For these display readings, no decimal points are used. Set SW4, SW5 and SW6 to OFF.

3. Desired display readings are:

4mA = ".000"
12mA = ".250"

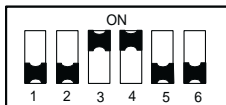

This example is not as straightforward as the previous two. Notice that 12mA is exactly halfway between 4mA and 20mA. If we assume that the input could go up to 20mA, the display reading would then be: 2 x .250 or ".500". From Table 1 we can now select DIP-switch setting #4 and enable DP1 via SW4. Apply 4mA and adjust R3 so the display reads ".000". Apply 12mA and adjust R7 so the display reads ".250".

DMS-20PC-4/20B (Bipolar Reading Model)

The DMS-20PC-4/20B's zero-offset circuit differs from the unipolar 'S' model described above in that with the 'B' model, a half-scale 12mA input is normally set to display "000". Therefore, all of the of the DIP-switch settings in Table 2 assume a reading of "000" is desired with a 12mA input. Display readings other than those shown in Table 2 are possible, contact Murata Power Solutions for more information.

When configuring the DMS-20PC-4/20B for the first time, or when selecting a new range, set both R3 and R7 fully clockwise (roughly 22 turns) to their minimum offset/minimum-span positions, respectively. Then select the desired readings from Table 2 and configure DIP-switches SW1, SW2, and SW3 accordingly.

The procedure below illustrates how to calibrate the DMS-20PC-4/20B to its factory-calibrated readings of "-1000" with a 4mA input and "1000" with a 20mA input. When performing DIP-switch settings, be sure the DIP-switch's small actuators are firmly engaged in their fully-ON or fully-OFF positions.

1. Set both R3 and R7 fully clockwise.
2. Select DIP-switch setting #1 from Table 2.
3. Apply a precision 12mA input and adjust R3 until the meter's display reads "000".
4. Apply a precision 20mA input and adjust R7 until the meter's display reads "1000".
5. Apply a precision 4mA input and the display should read "-1000". Repeat steps 3 and 4 to make sure the two adjustments did not affect one another.

Table 2. DMS-20PC-4/20B (Bipolar Model) DIP-Switch Settings

Display Reading			SW1	SW2	SW3
4mA	12mA	20mA			
1. -600 to -1000	000	600 to 1000	Off	Off	Off
2. -350 to -650	000	350 to 650	On	Off	Off
3. -250 to -400	000	250 to 400	Off	On	Off
4. -150 to -250	000	150 to 250	Off	Off	On
5. -100 to -150	000	100 to 150	On	On	On

Examples (DMS-20PC-4/20B-Bipolar Model)

1. Desired display readings are:

4mA = "-1.00"
20mA = "1.00"



Use DIP-switch setting #5 in Table 2 and enable decimal point DP2 via SW5. Apply 12mA and adjust R3 so the display reads "0.00". Apply 20mA and adjust R7 so the display reads "1.00". Apply 4mA and verify that the display reads "-1.00", readjust R3 and R7 if necessary.

2. Desired display readings are:

4mA = "-450"
20mA = "450"

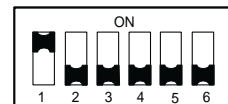

Use DIP-switch setting #2 in Table 2. Apply 12mA and adjust R3 so the display reads "000". Apply 20mA and adjust R7 so the display reads "450". Apply 4mA and verify that the display reads "-450". Repeat adjustment procedure if necessary. For these display readings, no decimal points are used. Set SW4, SW5 and SW6 to OFF.

3. Desired display readings are:

4mA = "-650"
20mA = "650"



Notice that these readings can be obtained using either DIP-switch setting #1 or DIP-switch setting #2 in Table 2. In situations like this where DIP-switch settings overlap, less-sensitive R3/R7 adjustments can be achieved if the higher DIP-setting # is selected (setting #2 in this example). Apply 12mA and adjust R3 so the display reads "000". Apply 20mA and adjust R7 so the display reads "650". Apply 4mA and verify that the display reads "-650". Repeat adjustment procedure if necessary.

DMS-20PC-4/20P (Positive Reading Model)

The DMS-20PC-4/20P's Zero-Offset circuit is optimized to produce positive readings at both 4mA and 20mA input levels. As shown in Table 3's first three columns, a 4mA input can be typically adjusted (using R3, Zero/Offset Adjust) to display any positive reading between "000" and "800". The corresponding 20mA-input reading is then added to the 4mA offset as a differential whose magnitude is varied by adjusting R7 (Gain/Span Adjust).

The 'Differential Range' column in Table 3 lists the nominal differential display-readings which can be obtained with R7 at, or very close to, its full-clockwise, minimum span position. The Differential Range column can be used as a guide when configuring the meter for the majority of user applications. Higher differential ranges are obtainable; however, the use of higher differential readings results in correspondingly-lower positive readings with 4mA inputs, that is, R3's clockwise adjustment-range is reduced. Example #3 below illustrates this concept. Please contact Murata Power Solutions if there is any doubt as to whether or not the DMS-20PC-4/20P can be configured for your display readings requirements.

The first step when configuring the DMS-20PC-4/20P for the first time, or when selecting a new range, is to set R3 fully counterclockwise and R7

fully clockwise (roughly 22 turns) to their minimum offset/minimum span positions, respectively.

The next step is to calculate the required display differential-reading; this is accomplished by subtracting the desired 4mA display reading from the desired 20mA display reading, disregarding decimal points. Then, using the calculated differential display-reading to select the appropriate DIP-switch setting # from Table 3, configure DIP-switches SW1, SW2, and SW3 accordingly. Make certain that the DIP-switch's small actuators are firmly engaged in their fully-ON or fully-OFF positions.

The procedure below describes how to calibrate the meter for an application which the DMS-20PC-4/20P easily accommodates: displaying the output of a 4-20mA transmitter, that is, "04.0" with a 4mA input and "20.0" with a 20mA input.

1. Set R3 fully counterclockwise (minimum offset position) and R7 fully clockwise (minimum differential span position), roughly 22 turns.
2. Subtract 040 from 200 to yield a differential value of 160; use this value to select DIP-switch setting #5 in Table 3. Enable decimal point DP3 by placing SW6 to the ON position.
3. Set the transmitter's output to 4.0mA and carefully adjust R3 clockwise until the meter's display reads "000".
4. Set the transmitter's output to 20.0mA and adjust R7 counterclockwise until the meter's display reads "16.0".
5. Set the transmitter back to 4.0mA and slowly adjust R3 clockwise until the display reads "04.0". Reapply 20.0mA and the display should now read "20.0". Repeat steps 3, 4 and 5 to make sure the adjustments did not affect one another.

**Table 3. DMS-20PC-4/20P (Positive Reading Model)
DIP-Switch Settings**

Display Reading			SW1	SW2	SW3
Differential Range	4mA Input	20mA Input			
1. 800-1400	900	1700	Off	Off	Off
2. 500-800	850	1350	On	Off	Off
3. 350-500	800	1150	Off	On	Off
4. 250-350	750	1000	Off	Off	On
5. 150-250	750	900	On	On	On

Table 4. Decimal Point Settings

SW4	SW5	SW6
DP1	DP2	DP3

Examples (DMS-20PC-4/20P-Positive Model)

1. Desired display readings are:

4mA = "650"
20mA = "950"



Use DIP-switch setting #4 in Table 3 since subtracting 650 from 950 yields a differential value of 300. Apply 4mA and adjust R3 until the display reads "000". Apply 20mA and adjust R7 until the display reads "300" (the differential value previously calculated). Apply 4mA and adjust R3 until the display reads "650". Apply 20mA and verify that the display reads "950".

2. Desired display readings are:

4mA = "4.00"
20mA = "19.99"

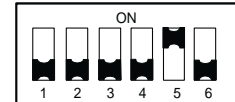

This example illustrates the DMS-20PC-4/20P's capability to display higher differential readings than those indicated in Table 3. This example also illustrates how the DMS-20PC-4/20P can be used to display the output levels of a 4-20mA loop transmitter with higher precision (0.01mA versus 0.1mA) than described above.

Subtracting 400 from 1999 yields a differential of 1599, a value not listed in Table 3. However, use DIP-switch setting #1 in Table 3 since this setting has the highest overall offset/span adjustment capabilities. Enable DP2 via SW5 then apply 4mA and adjust R3 so the display reads "0.00". Apply 20mA and adjust R7 so the display reads "15.99". Apply 4mA and adjust R3 until the display reads "4.00". Apply 20mA and check to see that the display reads "19.99" or just overranges ("1—"). Repeat adjustment procedure if necessary.

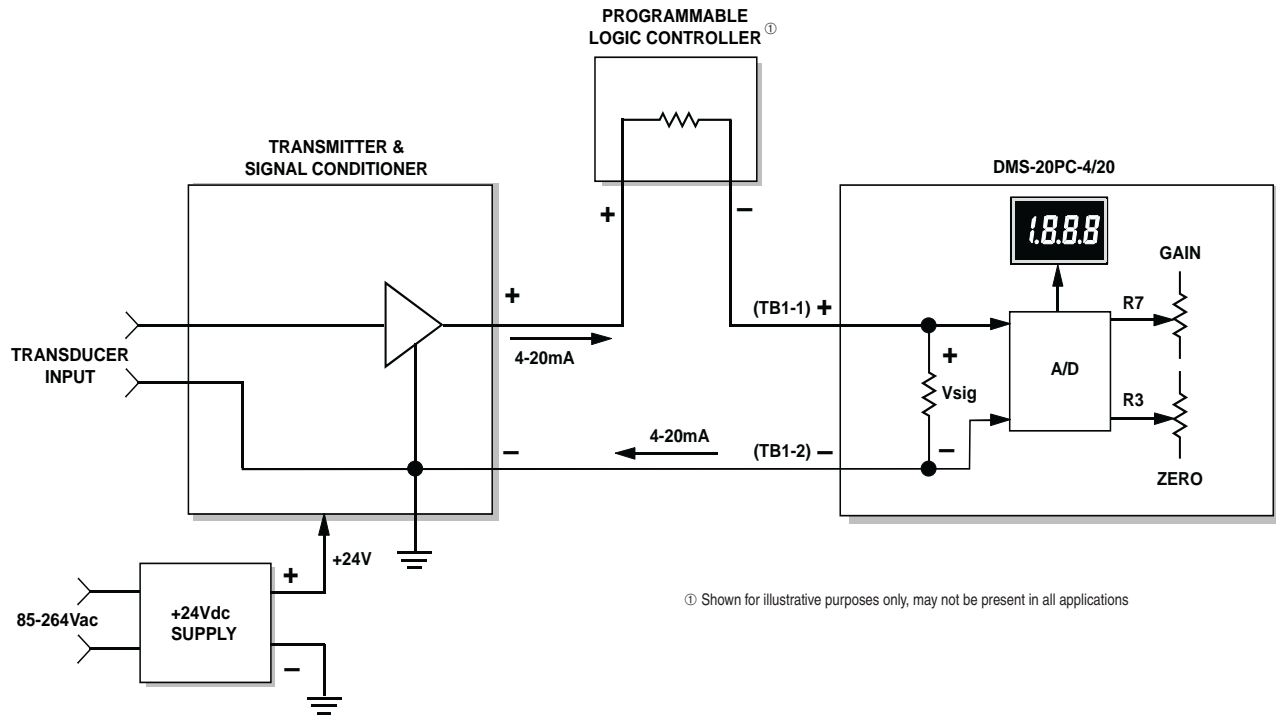
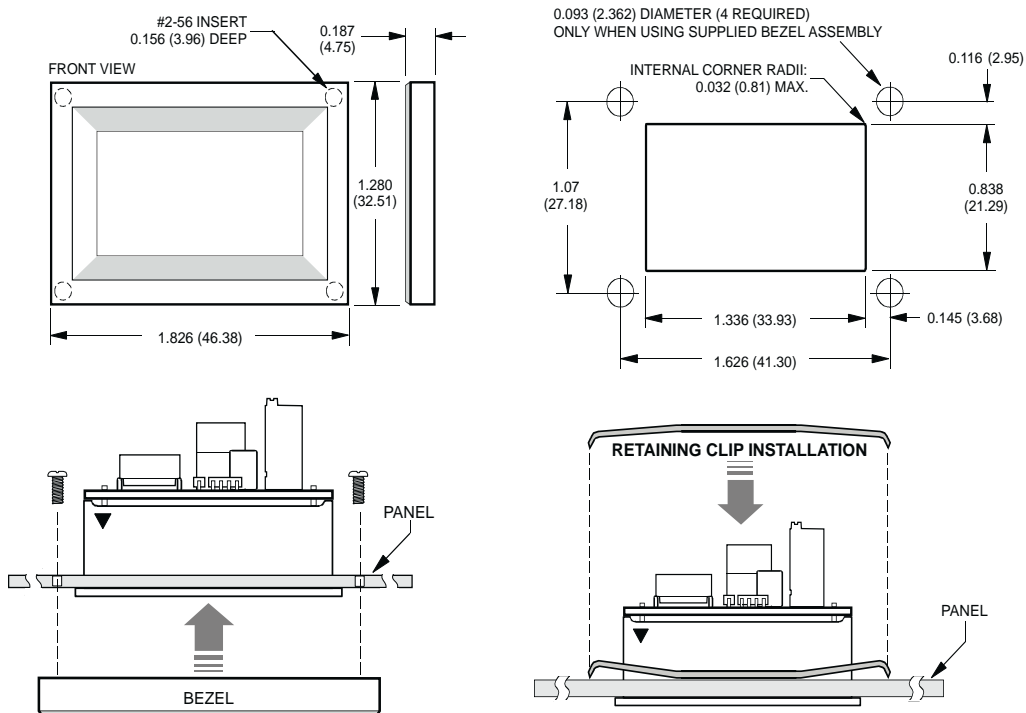

Figure 2. Typical DMS-20PC-4/20 Connection Diagram

BEZEL INSTALLATION AND RECOMMENDED DRILL AND PANEL CUTOUT



MECHANICAL SPECIFICATIONS

MECHANICAL DIMENSIONS: Inches (mm)

TOLERANCES: 2 PL DEC ±0.02 (±0.51)
3 PL DEC ±0.010 (±0.254)

WIRE SIZE: 18 to 26 AWG
(Solid or stranded)

STRIPPING LENGTH: 0.20" (5.08mm)

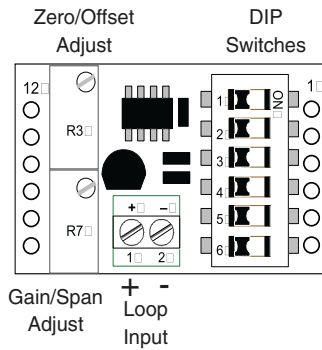
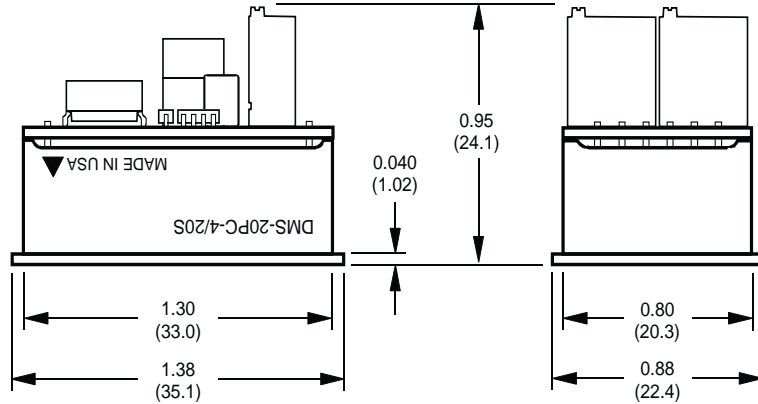

Back View



DP1 DP2 DP3
(SW4) (SW5) (SW6)

Front View

Murata Power Solutions, Inc.
11 Cabot Boulevard, Mansfield, MA 02048-1151 U.S.A.
ISO 9001 and 14001 REGISTERED



This product is subject to the following operating requirements and the Life and Safety Critical Application Sales Policy:
Refer to: <http://www.murata-ps.com/requirements/>

Murata Power Solutions, Inc. makes no representation that the use of its products in the circuits described herein, or the use of other technical information contained herein, will not infringe upon existing or future patent rights. The descriptions contained herein do not imply the granting of licenses to make, use, or sell equipment constructed in accordance therewith. Specifications are subject to change without notice.
© 2015 Murata Power Solutions, Inc.