

# Chip Beads

For signal line

## ACB series

Type:	HFxxACB2012	[0805 inch]*
	HFxxACB3216	[1206 inch]
	HFxxACB3225	[1210 inch]
	HFxxACB4532	[1812 inch]

\* Dimensions Code [EIA]

Issue date: September 2012

- All specifications are subject to change without notice.
- Conformity to RoHS Directive: This means that, in conformity with EU Directive 2002/95/EC, lead, cadmium, mercury, hexavalent chromium, and specific bromine-based flame retardants, PBB and PBDE, have not been used, except for exempted applications.

# Chip Beads For Signal Line

Conformity to RoHS Directive

## ACB Series

HFxxACB2012, HFxxACB3216, HFxxACB3225, HFxxACB4532

### FEATURES

- This extensive series completely covers impedance values ranging from 7 to 125Ω[100MHz] and can be applied to a wide range of circuits.
- The 2012, 3216, 3225 and 4532 types all use HF70, 50 and 30 materials. The most suitable component can be selected for the circuit pattern and the suppression band.
- These components are applicable for both flow and reflow solderings, and have outstanding physical characteristics such as excellent terminal strength, body strength, resistance to soldering heat, solderability and mounting reliability.
- Available reflow soldering.
- It is a product conforming to RoHS directive.

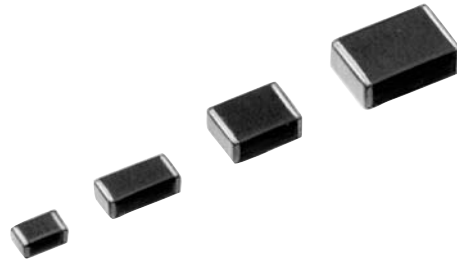

### PRODUCT IDENTIFICATION

HF70 ACB 201209 - T  
(1) (2) (3) (4)

- (1) Material name  
(2) Series name  
(3) Dimension code  
(4) Packaging style  
T: ø180mm reel taping  
TL: ø330mm reel taping

### SPECIFICATIONS

Operating temperature range	-40 to +125°C
Storage temperature range	-40 to +125°C(After mount)

### PACKAGING STYLE AND QUANTITIES

Packaging style	Type	Quantity
Taping	201209	2000 pieces/reel
	321611	2000 pieces/reel
	322513	2000 pieces/reel
	453215	1000 pieces/reel

### HANDLING AND PRECAUTIONS

- Before soldering, be sure to preheat components. The preheating temperature should be set so that the temperature difference between the solder temperature and product temperature does not exceed 150°C.
- After mounting components onto the printed circuit board, do not apply stress through board bending or mishandling.
- Do not expose the inductors to stray magnetic fields.
- Avoid static electricity discharge during handling.
- When hand soldering, apply the soldering iron to the printed circuit board only. Temperature of the iron tip should not exceed 350°C. Soldering time should not exceed 3 seconds.

• Conformity to RoHS Directive: This means that, in conformity with EU Directive 2002/95/EC, lead, cadmium, mercury, hexavalent chromium, and specific bromine-based flame retardants, PBB and PBDE, have not been used, except for exempted applications.

• Please contact our Sales office when your application is considered the following:  
The device's failure or malfunction may directly endanger human life (e.g. application for automobile/aircraft/medical/nuclear power devices, etc.)

• All specifications are subject to change without notice.

### SHAPES AND DIMENSIONS/CIRCUIT DIAGRAM

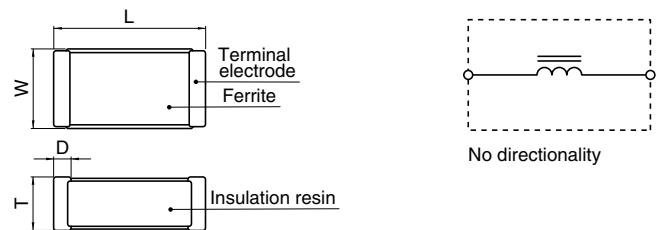

Dimensions in mm

Type	L	W	T	D
201209	2.0±0.2	1.25±0.2	0.9±0.2	0.3±0.2
321611	3.2±0.2	1.6±0.2	1.1±0.2	0.3±0.2
322513	3.2±0.2	2.5±0.2	1.3±0.2	0.3±0.2
453215	4.5±0.25	3.2±0.25	1.5±0.25	0.3±0.2

### RECOMMENDED PC BOARD PATTERN REFLOW SOLDERING

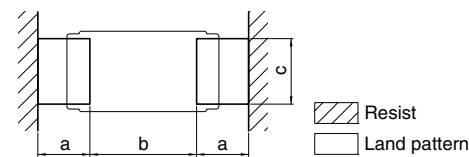

Dimensions in mm

Type	a	b	c
201209	1.0	1.0	1.0
321611	1.1	2.2	1.4
322513	1.1	2.2	2.3
453215	1.5	3.0	3.0

## ELECTRICAL CHARACTERISTICS

Type	Part No.	Impedance ( $\Omega$ )[100MHz]	DC resistance ( $\Omega$ )max.	Rated current (mA)max.
201209	HF70ACB201209	10 $\pm$ 25%	0.1	600
	HF50ACB201209	11 $\pm$ 25%	0.1	600
	HF30ACB201209	7 $\pm$ 25%	0.1	600
321611	HF70ACB321611	26 $\pm$ 25%	0.2	500
	HF50ACB321611	31 $\pm$ 25%	0.2	500
	HF30ACB321611	19 $\pm$ 25%	0.2	500
322513	HF70ACB322513	52 $\pm$ 25%	0.3	400
	HF50ACB322513	60 $\pm$ 25%	0.3	400
	HF30ACB322513	31 $\pm$ 25%	0.3	400
453215	HF70ACB453215	120 $\pm$ 25%	0.4	300
	HF50ACB453215	125 $\pm$ 25%	0.4	300
	HF30ACB453215	70 $\pm$ 25%	0.4	300

## RECOMMENDED SOLDERING CONDITION

### REFLOW SOLDERING

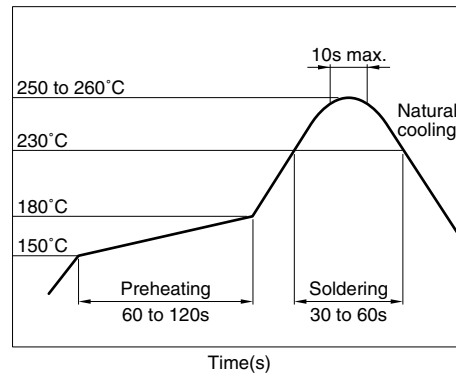

## TYPICAL ELECTRICAL CHARACTERISTICS

### Z, X, R vs. FREQUENCY CHARACTERISTICS

#### HF70ACB201209

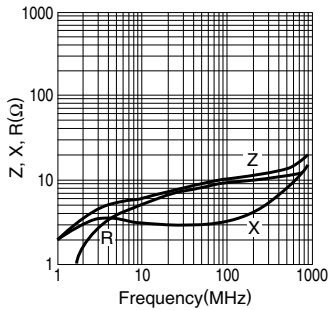

#### HF50ACB201209

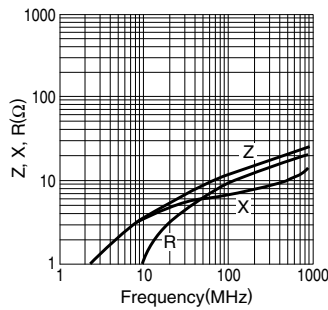

#### HF30ACB201209

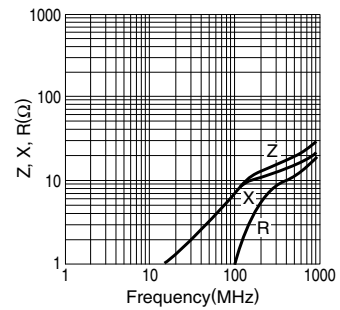

#### HF70ACB321611

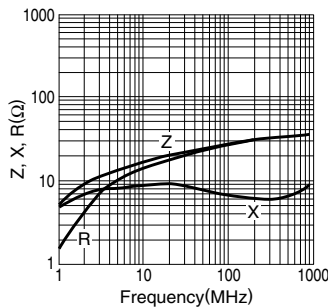

#### HF50ACB321611

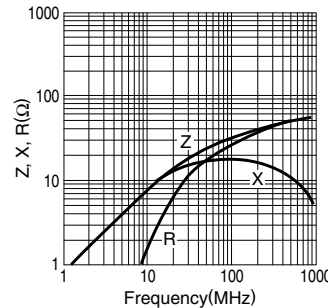

#### HF30ACB321611

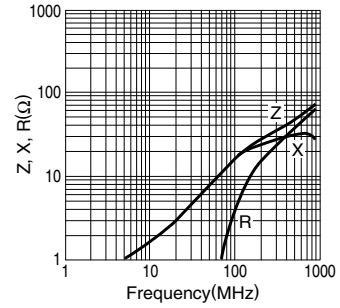

#### HF70ACB322513

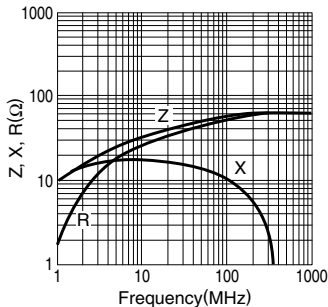

#### HF50ACB322513

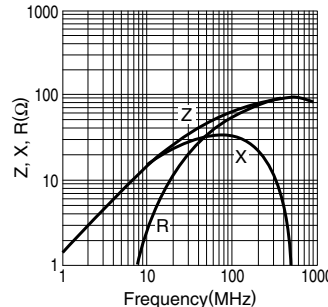

#### HF30ACB322513

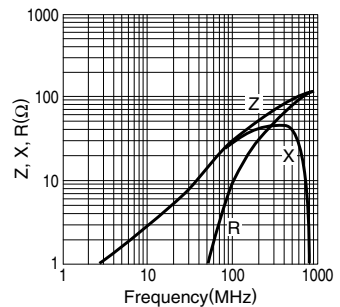

• TEST EQUIPMENT: RF IMPEDANCE ANALYZER YHP4191A

• All specifications are subject to change without notice.

**TYPICAL ELECTRICAL CHARACTERISTICS**  
**Z, X, R vs. FREQUENCY CHARACTERISTICS**  
**HF70ACB453215**

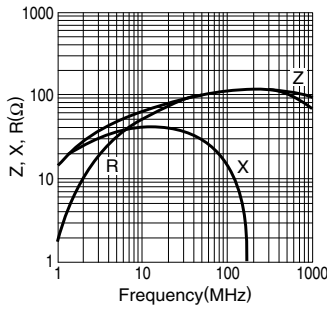

**HF50ACB453215**

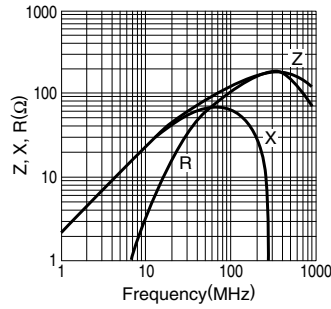

**HF30ACB453215**

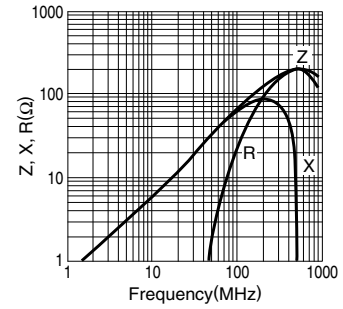

• TEST EQUIPMENT: RF IMPEDANCE ANALYZER YHP4191A

**PACKAGING STYLES**  
**201209 TO 322513 TYPES**  
**REEL DIMENSIONS**

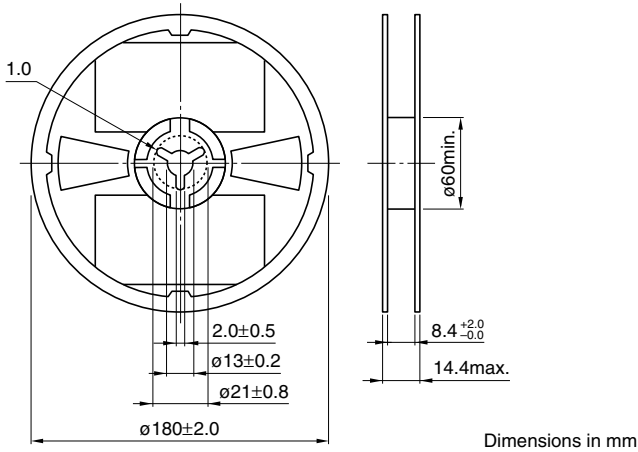

**453215 TYPE**  
**REEL DIMENSIONS**

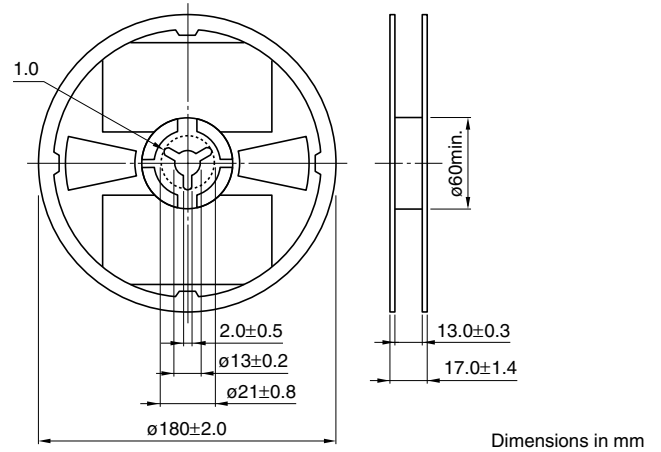

**TAPE DIMENSIONS**

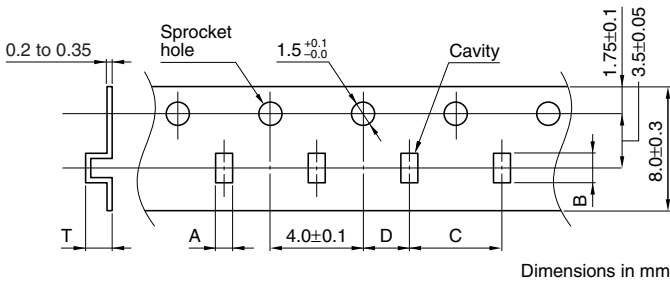

Type	A	B	C	D	T
201209	1.4±0.1	2.25±0.1	4.0±0.1	2.0±0.05	1.25max.
321611	1.75±0.1	3.45±0.1	4.0±0.1	2.0±0.05	1.4max.
322513	2.6±0.1	3.45±0.1	4.0±0.1	2.0±0.05	1.6max.

**TAPE DIMENSIONS**

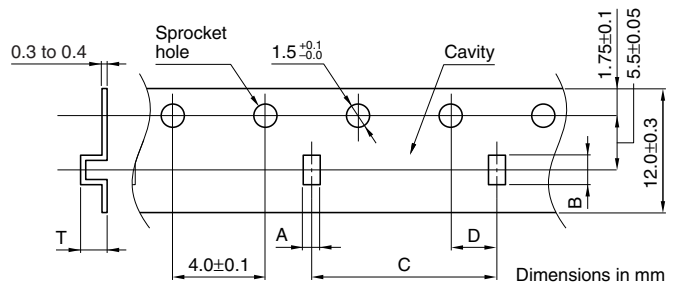

Type	A	B	C	D	T
453215	3.37±0.1	4.75±0.1	8.0±0.1	2.0±0.05	1.8max.

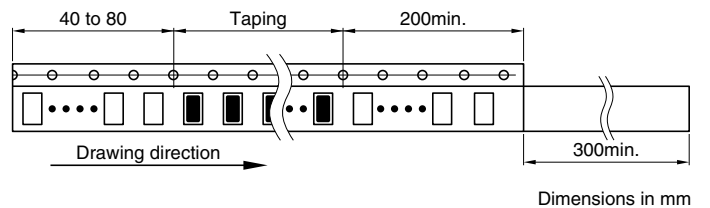
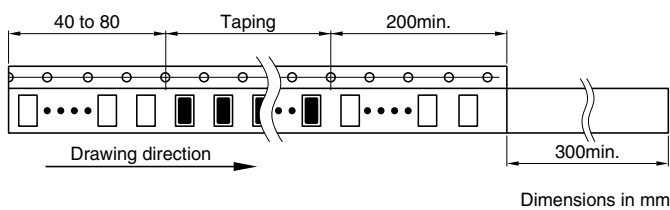

• All specifications are subject to change without notice.