

# SMD Inductors(Coils) For High Frequency(Multilayer)

Conformity to RoHS Directive

## MLG Series MLG0603Q Type\*

\* This product will be removed from the catalog at the end of March, 2011. Please consider our new MLG0603P series of products with equivalent characteristics.

### FEATURES

- It serializes a product of inductance 0.2 to 100nH. In a product of 0.2 to 4.0nH, it realizes line up in a 0.1nH steps.
- By the most suitable design, Q is higher than competing in a conventional product MLG0603S type. In particular, Q in more than 800MHz largely improved.
- Advanced monolithic structure is formed using a multilayering and sintering process with ceramic and conductive materials for high-frequency.
- The products contain no lead and also support lead-free soldering.
- It is a product conforming to RoHS directive.

### APPLICATIONS

For high-frequency applications including mobile phones, high frequency modules (PA, VCO, FEM etc.), Bluetooth, W-LAN, UWB and tuners.

### SHAPES AND DIMENSIONS

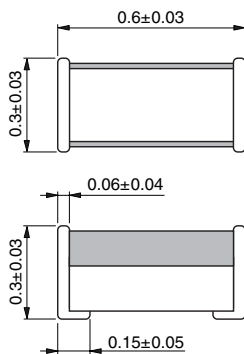

Weight: 0.2mg

Dimensions in mm



### RECOMMENDED PC BOARD PATTERN

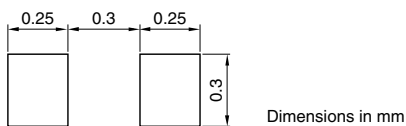

Dimensions in mm

### RECOMMENDED SOLDERING CONDITION REFLOW SOLDERING

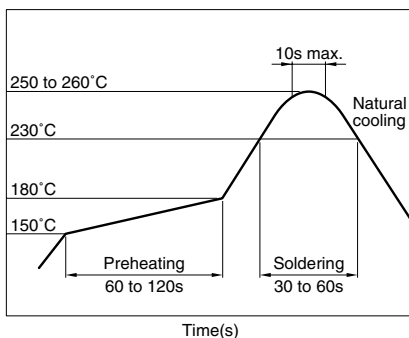

- Conformity to RoHS Directive: This means that, in conformity with EU Directive 2002/95/EC, lead, cadmium, mercury, hexavalent chromium, and specific bromine-based flame retardants, PBB and PBDE, have not been used, except for exempted applications.

- Please contact our Sales office when your application are considered the following:

The device's failure or malfunction may directly endanger human life (e.g. application for automobile/aircraft/medical/nuclear power devices, etc.)

- All specifications are subject to change without notice.

### PRODUCT IDENTIFICATION

MLG	0603	Q	2N2	S	T
(1)	(2)	(3)	(4)	(5)	(6)

(1) Series name

(2) Dimensions

0603	0.6×0.3mm (L×W)
------	-----------------

(3) Material code

(4) Inductance value

2N2	2.2nH
12N	12nH

(5) Inductance tolerance

B	±0.1nH
C	±0.2nH
S	±0.3nH
H	±3%
J	±5%

(6) Packaging style

T	Taping (reel)
---	---------------

### SPECIFICATIONS

Operating temperature range	-55 to +125°C
Storage temperature range	-55 to +125°C

### PACKAGING STYLE AND QUANTITIES

Packaging style	Quantity
Taping	15000 pieces/reel

### HANDLING AND PRECAUTIONS

- Before soldering, be sure to preheat components.  
The preheating temperature should be set so that the temperature difference between the solder temperature and product temperature does not exceed 150°C.
- After mounting components onto the printed circuit board, do not apply stress through board bending or mishandling.
- When hand soldering, apply the soldering iron to the printed circuit board only. Temperature of the iron tip should not exceed 350°C. Soldering time should not exceed 3 seconds.

## ELECTRICAL CHARACTERISTICS

Inductance (nH)	Inductance tolerance	Q min.	Test frequency L, Q (MHz)	Self-resonant frequency (GHz)		DC resistance ( $\Omega$ )		Rated current (mA)max.	Part No.*
				min.	typ.	max.	typ.		
0.2	$\pm 0.1, \pm 0.2\text{nH}$	—	100	10.0	20 up	0.10	0.01	600	MLG0603Q0N2□
0.3	$\pm 0.1, \pm 0.2\text{nH}$	—	100	10.0	20 up	0.10	0.02	600	MLG0603Q0N3□
0.4	$\pm 0.1, \pm 0.2\text{nH}$	—	100	10.0	20 up	0.10	0.02	600	MLG0603Q0N4□
0.5	$\pm 0.1, \pm 0.2\text{nH}$	—	100	10.0	20 up	0.10	0.02	600	MLG0603Q0N5□
0.6	$\pm 0.1, \pm 0.2\text{nH}$	—	100	10.0	20 up	0.10	0.03	600	MLG0603Q0N6□
0.7	$\pm 0.1, \pm 0.2\text{nH}$	—	100	10.0	20 up	0.10	0.04	600	MLG0603Q0N7□
0.8	$\pm 0.1, \pm 0.2\text{nH}$	—	100	10.0	17.5	0.10	0.03	600	MLG0603Q0N8□
0.9	$\pm 0.1, \pm 0.2\text{nH}$	—	100	10.0	16.3	0.10	0.04	600	MLG0603Q0N9□
1.0	$\pm 0.1, \pm 0.2, 0.3\text{nH}$	5	100	10.0	14.2	0.10	0.06	600	MLG0603Q1N0□
1.1	$\pm 0.1, \pm 0.2, 0.3\text{nH}$	5	100	10.0	14.9	0.15	0.06	550	MLG0603Q1N1□
1.2	$\pm 0.1, \pm 0.2, 0.3\text{nH}$	5	100	10.0	14.7	0.15	0.05	550	MLG0603Q1N2□
1.3	$\pm 0.1, \pm 0.2, 0.3\text{nH}$	5	100	10.0	13.6	0.15	0.05	550	MLG0603Q1N3□
1.4	$\pm 0.1, \pm 0.2, 0.3\text{nH}$	5	100	9.0	12.0	0.15	0.06	550	MLG0603Q1N4□
1.5	$\pm 0.1, \pm 0.2, 0.3\text{nH}$	5	100	9.0	10.7	0.20	0.08	550	MLG0603Q1N5□
1.6	$\pm 0.1, \pm 0.2, 0.3\text{nH}$	5	100	9.0	11.3	0.20	0.08	500	MLG0603Q1N6□
1.7	$\pm 0.1, \pm 0.2, 0.3\text{nH}$	5	100	8.5	10.0	0.20	0.08	500	MLG0603Q1N7□
1.8	$\pm 0.1, \pm 0.2, 0.3\text{nH}$	5	100	8.5	10.3	0.20	0.09	500	MLG0603Q1N8□
1.9	$\pm 0.1, \pm 0.2, 0.3\text{nH}$	5	100	7.5	8.9	0.20	0.08	500	MLG0603Q1N9□
2.0	$\pm 0.1, \pm 0.2, 0.3\text{nH}$	5	100	7.5	9.4	0.20	0.09	500	MLG0603Q2N0□
2.1	$\pm 0.1, \pm 0.2, 0.3\text{nH}$	5	100	7.5	8.8	0.20	0.09	500	MLG0603Q2N1□
2.2	$\pm 0.1, \pm 0.2, 0.3\text{nH}$	5	100	7.5	9.3	0.20	0.08	500	MLG0603Q2N2□
2.3	$\pm 0.1, \pm 0.2, 0.3\text{nH}$	5	100	7.5	10.0	0.30	0.17	450	MLG0603Q2N3□
2.4	$\pm 0.1, \pm 0.2, 0.3\text{nH}$	5	100	7.5	9.3	0.30	0.14	450	MLG0603Q2N4□
2.5	$\pm 0.1, \pm 0.2, 0.3\text{nH}$	5	100	7.0	9.1	0.30	0.17	450	MLG0603Q2N5□
2.6	$\pm 0.1, \pm 0.2, 0.3\text{nH}$	5	100	6.5	8.0	0.30	0.13	450	MLG0603Q2N6□
2.7	$\pm 0.1, \pm 0.2, 0.3\text{nH}$	5	100	6.5	7.7	0.30	0.11	450	MLG0603Q2N7□
2.8	$\pm 0.1, \pm 0.2, 0.3\text{nH}$	5	100	6.2	7.9	0.30	0.14	300	MLG0603Q2N8□
2.9	$\pm 0.1, \pm 0.2, 0.3\text{nH}$	5	100	6.2	7.6	0.30	0.13	300	MLG0603Q2N9□
3.0	$\pm 0.1, \pm 0.2, 0.3\text{nH}$	5	100	6.0	7.4	0.30	0.12	300	MLG0603Q3N0□
3.1	$\pm 0.1, \pm 0.2, 0.3\text{nH}$	5	100	6.0	7.2	0.30	0.15	300	MLG0603Q3N1□
3.2	$\pm 0.1, \pm 0.2, 0.3\text{nH}$	5	100	6.0	7.1	0.30	0.15	300	MLG0603Q3N2□
3.3	$\pm 0.1, \pm 0.2, 0.3\text{nH}$	5	100	5.8	7.1	0.30	0.15	300	MLG0603Q3N3□
3.4	$\pm 0.1, \pm 0.2, 0.3\text{nH}$	5	100	5.8	7.1	0.30	0.15	300	MLG0603Q3N4□
3.5	$\pm 0.1, \pm 0.2, 0.3\text{nH}$	5	100	5.8	6.8	0.35	0.18	300	MLG0603Q3N5□
3.6	$\pm 0.1, \pm 0.2, 0.3\text{nH}$	5	100	5.8	7.4	0.35	0.20	300	MLG0603Q3N6□
3.7	$\pm 0.1, \pm 0.2, 0.3\text{nH}$	5	100	5.8	7.4	0.40	0.23	300	MLG0603Q3N7□
3.8	$\pm 0.1, \pm 0.2, 0.3\text{nH}$	5	100	5.8	7.3	0.40	0.23	300	MLG0603Q3N8□
3.9	$\pm 0.1, \pm 0.2, 0.3\text{nH}$	5	100	5.8	7.3	0.40	0.24	300	MLG0603Q3N9□
4.0	$\pm 0.1, \pm 0.2, 0.3\text{nH}$	5	100	5.8	7.1	0.40	0.23	300	MLG0603Q4N0□
4.3	$\pm 3\%, \pm 0.3\text{nH}$	5	100	5.2	6.4	0.40	0.21	300	MLG0603Q4N3□
4.7	$\pm 3\%, \pm 0.3\text{nH}$	5	100	5.2	6.9	0.45	0.25	300	MLG0603Q4N7□
5.1	$\pm 3\%, \pm 0.3\text{nH}$	5	100	5.0	6.0	0.50	0.30	250	MLG0603Q5N1□
5.6	$\pm 3\%, \pm 0.3\text{nH}$	5	100	4.2	5.5	0.50	0.28	250	MLG0603Q5N6□
6.2	$\pm 3\%, \pm 0.3\text{nH}$	5	100	4.2	5.3	0.55	0.32	250	MLG0603Q6N2□
6.8	$\pm 3, \pm 5\%$	5	100	4.2	5.5	0.60	0.34	250	MLG0603Q6N8□
7.5	$\pm 3, \pm 5\%$	5	100	3.8	4.8	0.70	0.36	220	MLG0603Q7N5□
8.2	$\pm 3, \pm 5\%$	5	100	3.8	4.9	0.70	0.44	220	MLG0603Q8N2□
9.1	$\pm 3, \pm 5\%$	5	100	3.6	4.4	0.80	0.49	200	MLG0603Q9N1□
10	$\pm 3, \pm 5\%$	5	100	3.6	4.7	0.80	0.52	200	MLG0603Q10N□
11	$\pm 3, \pm 5\%$	6	100	3.6	4.5	0.80	0.48	200	MLG0603Q11N□
12	$\pm 3, \pm 5\%$	6	100	3.0	3.8	1.00	0.56	180	MLG0603Q12N□
13	$\pm 3, \pm 5\%$	6	100	3.0	3.9	1.00	0.63	180	MLG0603Q13N□
15	$\pm 3, \pm 5\%$	6	100	3.0	3.8	1.10	0.69	180	MLG0603Q15N□
16	$\pm 3, \pm 5\%$	6	100	2.8	3.6	1.10	0.64	180	MLG0603Q16N□
18	$\pm 3, \pm 5\%$	6	100	2.5	3.3	1.20	0.75	150	MLG0603Q18N□

\* □: Please specify inductance tolerance, B ( $\pm 0.1\text{nH}$ ), C ( $\pm 0.2\text{nH}$ ), S ( $\pm 0.3\text{nH}$ ), H ( $\pm 3\%$ ) or J ( $\pm 5\%$ ).

• Test equipment

Inductance Q : HP4291A+16197A, or equivalent

SRF: HP8720C, or equivalent

Rdc: YOKOGAWA TYPE7561, or equivalent

• All specifications are subject to change without notice.

## ELECTRICAL CHARACTERISTICS

Inductance (nH)	Inductance tolerance	Q min.	Test frequency L, Q (MHz)	Self-resonant frequency (GHz)		DC resistance ( $\Omega$ )		Rated current (mA)max.	Part No.*
				min.	typ.	max.	typ.		
20	$\pm 3, \pm 5\%$	6	100	2.3	3	1.20	0.80	150	MLG0603Q20N□
22	$\pm 3, \pm 5\%$	6	100	2.2	2.9	1.20	0.83	150	MLG0603Q22N□
24	$\pm 3, \pm 5\%$	6	100	2.1	2.7	1.30	0.90	150	MLG0603Q24N□
27	$\pm 3, \pm 5\%$	6	100	2	2.6	1.50	0.96	100	MLG0603Q27N□
30	$\pm 3, \pm 5\%$	6	100	1.8	2.4	1.50	1.06	100	MLG0603Q30N□
33	$\pm 3, \pm 5\%$	6	100	1.7	2.4	1.70	2.40	100	MLG0603Q33N□
36	$\pm 3, \pm 5\%$	6	100	1.6	2.2	1.80	1.21	80	MLG0603Q36N□
39	$\pm 3, \pm 5\%$	6	100	1.5	1.9	2.50	1.80	80	MLG0603Q39N□
43	$\pm 3, \pm 5\%$	6	100	1.4	1.8	2.70	1.94	80	MLG0603Q43N□
47	$\pm 3, \pm 5\%$	6	100	1.3	1.7	2.70	1.88	80	MLG0603Q47N□
51	$\pm 3, \pm 5\%$	6	100	1.3	1.6	2.80	2.04	60	MLG0603Q51N□
56	$\pm 3, \pm 5\%$	6	100	1.2	1.5	3.20	2.27	60	MLG0603Q56N□
62	$\pm 3, \pm 5\%$	6	100	1.1	1.4	3.30	2.38	60	MLG0603Q62N□
68	$\pm 3, \pm 5\%$	6	100	1.1	1.4	3.50	2.53	60	MLG0603Q68N□
75	$\pm 3, \pm 5\%$	6	100	1.05	1.3	3.80	2.70	60	MLG0603Q75N□
82	$\pm 3, \pm 5\%$	6	100	1	1.3	4.00	2.93	60	MLG0603Q82N□
91	$\pm 3, \pm 5\%$	6	100	0.9	1.2	4.30	3.01	60	MLG0603Q91N□
100	$\pm 3, \pm 5\%$	6	100	0.85	1.1	4.50	3.16	60	MLG0603QR10□

\* □: Please specify inductance tolerance, B ( $\pm 0.1$ nH), C ( $\pm 0.2$ nH), S ( $\pm 0.3$ nH), H ( $\pm 3\%$ ) or J ( $\pm 5\%$ ).

• Test equipment

Inductance Q : HP4291A+16197A, or equivalent

SRF: HP8720C, or equivalent

Rdc: YOKOGAWA TYPE7561, or equivalent

## L, Q vs. FREQUENCY CHARACTERISTICS

Part No.	Inductance(nH)typ.					Q typ.				
	500MHz	800MHz	1.8GHz	2.0GHz	2.4GHz	500MHz	800MHz	1.8GHz	2.0GHz	2.4GHz
MLG0603Q0N2	0.2	0.2	0.2	0.2	0.2	27	30	47	48	56
MLG0603Q0N3	0.3	0.3	0.3	0.3	0.3	17	22	36	37	42
MLG0603Q0N4	0.4	0.4	0.4	0.4	0.4	17	22	34	35	39
MLG0603Q0N5	0.5	0.5	0.45	0.45	0.45	15	20	31	33	37
MLG0603Q0N6	0.6	0.6	0.5	0.5	0.5	17	22	34	36	39
MLG0603Q0N7	0.7	0.6	0.6	0.6	0.6	17	22	35	36	41
MLG0603Q0N8	0.7	0.7	0.7	0.7	0.7	17	23	36	37	42
MLG0603Q0N9	0.8	0.8	0.8	0.8	0.8	18	23	36	38	42
MLG0603Q1N0	0.9	0.9	0.9	0.9	0.9	18	23	36	38	43
MLG0603Q1N1	1.0	1.0	1.0	1.0	1.0	16	20	32	34	38
MLG0603Q1N2	1.1	1.1	1.1	1.1	1.1	17	21	33	34	39
MLG0603Q1N3	1.2	1.2	1.2	1.2	1.2	17	21	33	35	39
MLG0603Q1N4	1.3	1.3	1.3	1.3	1.3	17	22	34	36	41
MLG0603Q1N5	1.4	1.4	1.4	1.4	1.4	17	21	33	35	39
MLG0603Q1N6	1.5	1.5	1.5	1.5	1.5	18	23	36	38	42
MLG0603Q1N7	1.6	1.6	1.6	1.6	1.6	19	24	38	40	45
MLG0603Q1N8	1.7	1.7	1.7	1.7	1.7	18	23	35	37	41
MLG0603Q1N9	1.8	1.8	1.8	1.8	1.8	20	25	40	42	47
MLG0603Q2N0	1.9	1.9	1.9	1.9	1.9	18	23	36	38	42
MLG0603Q2N1	2.0	2.0	2.0	2.0	2.1	19	24	37	39	43
MLG0603Q2N2	2.0	2.0	2.1	2.1	2.1	16	20	31	33	36
MLG0603Q2N3	2.2	2.2	2.2	2.2	2.3	17	23	36	37	42
MLG0603Q2N4	2.3	2.3	2.3	2.3	2.4	18	23	36	38	42
MLG0603Q2N5	2.4	2.4	2.4	2.4	2.5	18	23	35	37	40
MLG0603Q2N6	2.5	2.4	2.5	2.5	2.6	18	23	35	37	40
MLG0603Q2N7	2.5	2.5	2.6	2.6	2.7	17	22	33	34	38
MLG0603Q2N8	2.6	2.6	2.7	2.7	2.8	19	24	36	37	41
MLG0603Q2N9	2.7	2.7	2.8	2.9	3.0	19	24	36	37	40
MLG0603Q3N0	2.8	2.8	2.9	3.0	3.1	19	24	35	36	39
MLG0603Q3N1	2.9	2.9	3.0	3.1	3.2	18	23	34	36	38
MLG0603Q3N2	3.0	3.0	3.1	3.2	3.3	18	23	34	35	38
MLG0603Q3N3	3.1	3.1	3.2	3.3	3.4	18	23	34	35	38
MLG0603Q3N4	3.2	3.2	3.3	3.4	3.5	18	23	33	35	37
MLG0603Q3N5	3.3	3.3	3.4	3.5	3.6	17	22	32	33	36
MLG0603Q3N6	3.4	3.4	3.5	3.6	3.7	16	21	32	34	37
MLG0603Q3N7	3.5	3.5	3.6	3.7	3.8	18	23	34	35	38
MLG0603Q3N8	3.6	3.6	3.7	3.8	3.9	17	23	34	35	38
MLG0603Q3N9	3.7	3.7	3.8	3.9	4.0	17	22	33	35	38

• All specifications are subject to change without notice.

## L, Q vs. FREQUENCY CHARACTERISTICS

Part No.	Inductance(nH)typ.					Q typ.				
	500MHz	800MHz	1.8GHz	2.0GHz	2.4GHz	500MHz	800MHz	1.8GHz	2.0GHz	2.4GHz
MLG0603Q4N0	3.8	3.8	4.0	4.0	4.2	18	23	34	35	38
MLG0603Q4N3	4.1	4.1	4.3	4.4	4.6	17	22	32	33	36
MLG0603Q4N7	4.4	4.4	4.6	4.7	4.9	16	21	32	33	36
MLG0603Q5N1	4.9	4.9	5.1	5.3	5.5	17	22	32	33	36
MLG0603Q5N6	5.3	5.4	5.7	5.9	6.2	18	23	32	33	35
MLG0603Q6N2	5.9	5.9	6.4	6.6	7.1	17	22	31	31	33
MLG0603Q6N8	6.4	6.4	6.9	7.1	7.6	17	21	30	31	33
MLG0603Q7N5	7.1	7.2	8.1	8.5	9.4	17	22	29	30	30
MLG0603Q8N2	7.8	7.8	8.5	8.8	9.5	16	20	28	28	29
MLG0603Q9N1	8.7	8.8	9.9	10.4	11.5	17	21	27	27	27
MLG0603Q10N	9.5	9.6	10.8	11.3	12.5	16	21	27	28	28
MLG0603Q11N	10.4	10.5	12.2	12.9	14.8	15	18	24	24	24
MLG0603Q12N	11.5	11.7	14.3	15.5	18.8	16	20	24	23	21
MLG0603Q13N	12.3	12.5	15.1	16.4	19.7	15	19	24	24	22
MLG0603Q15N	14.4	14.6	17.4	18.8	22.2	17	21	26	26	24
MLG0603Q16N	15.2	15.6	19.8	22.0	28.2	15	19	22	22	19
MLG0603Q18N	17.2	17.6	23.4	26.4	35.8	15	18	21	20	17
MLG0603Q20N	19.1	19.7	27.7	32.4	49.3	14	17	18	16	12
MLG0603Q22N	21.0	21.8	31.6	37.6	61.9	14	17	18	16	11
MLG0603Q24N	23.0	24.1	38.1	48.0	104.7	14	16	15	13	6
MLG0603Q27N	26.0	27.3	44.9	58.4	168.9	14	17	15	12	5
MLG0603Q30N	29.0	30.7	57.1	81.7		14	17	13	10	2
MLG0603Q33N	32.1	34.2	68.9	107.2		15	17	12	8	
MLG0603Q36N	35.1	37.9	90.9	175.3		14	16	9	5	
MLG0603Q39N	38.8	43.3	248.9			14	15	3		
MLG0603Q43N	43.0	48.6	345.5			14	15	1		
MLG0603Q47N	47.2	53.8				14	14	1		
MLG0603Q51N	51.6	60.0				13	13			
MLG0603Q56N	58.1	70.9				13	13			
MLG0603Q62N	64.8	81.5				13	12			
MLG0603Q68N	71.8	91.8				13	12			
MLG0603Q75N	80.4	107.5				13	11			
MLG0603Q82N	89.1	123.8				12	10			
MLG0603Q91N	101.9	156.4				11	9			
MLG0603QR10	115.1	192.3				11	8			

## TYPICAL ELECTRICAL CHARACTERISTICS

### INDUCTANCE vs. FREQUENCY CHARACTERISTICS

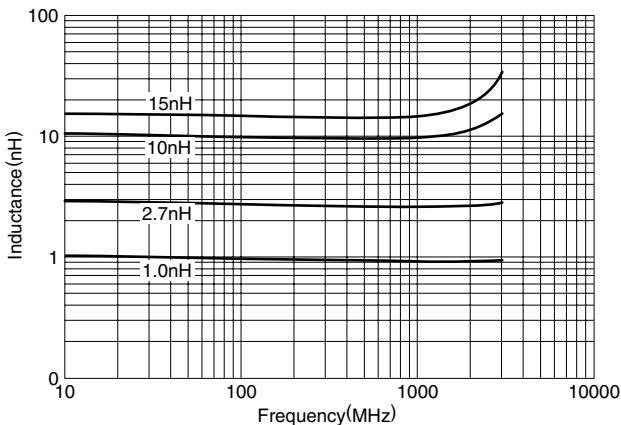

### Q vs. FREQUENCY CHARACTERISTICS

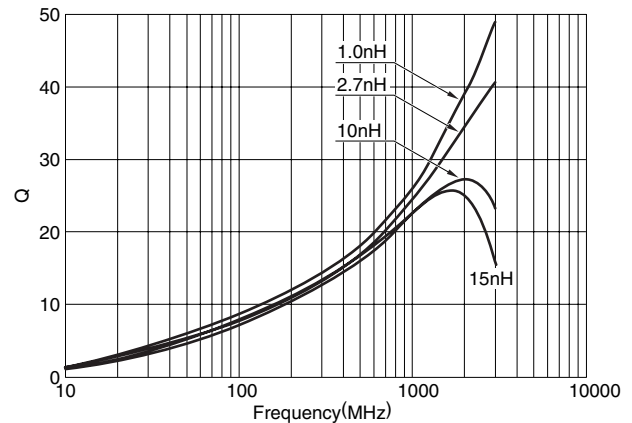

• All specifications are subject to change without notice.

**PACKAGING STYLES**  
**REEL DIMENSIONS**

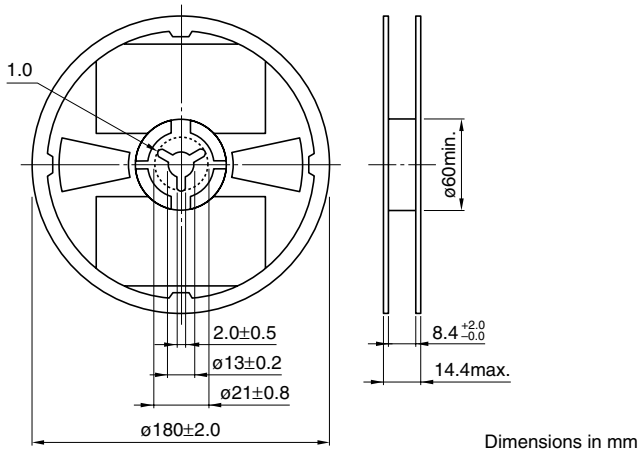

**TAPE DIMENSIONS**

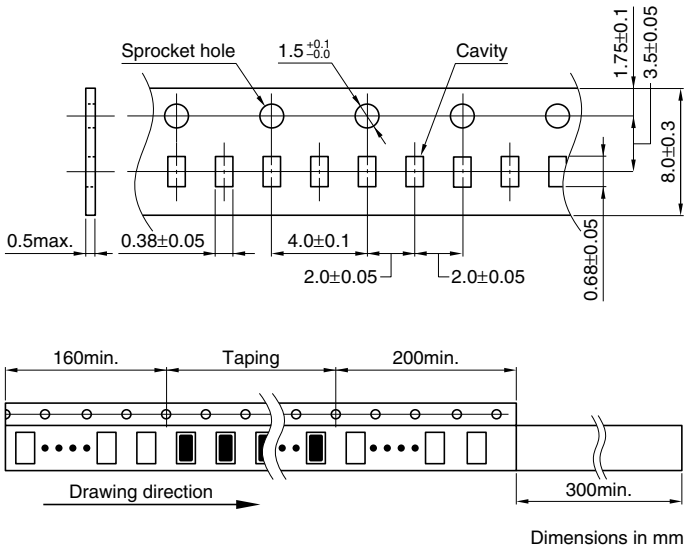

• All specifications are subject to change without notice.