

## GaAs MMIC SP4T NON-REFLECTIVE SWITCH, DC - 4 GHz

### Typical Applications

The HMC244G16 is ideal for:

- Telecom Infrastructure
- Military Radios, Radar & ECM
- Space Applications
- Test Instrumentation

### Functional Diagram

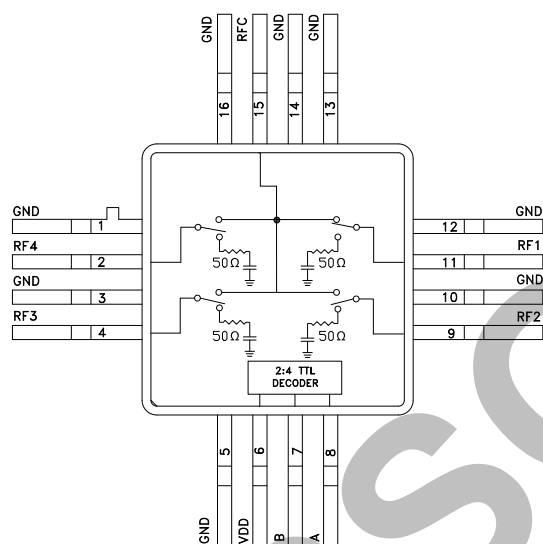

### Features

- Low Insertion Loss: 0.7 dB
- Non-Reflective Design
- Integrated 2:4 TTL Decoder
- Single Positive Supply: Vdd = +5V
- 16 Lead Hermetic SMT Package

### General Description

The HMC244G16 is a non-reflective SP4T switch in a 16 lead glass/metal (hermetic) package. Covering DC to 4 GHz, the switch offers 30~50 dB isolation and a low insertion loss of 0.7 dB through 3 GHz. A 2:4 TTL/CMOS compatible decoder is integrated on the switch requiring only 2 control lines and a positive 5V bias to select each path, replacing 8 control lines normally required by GaAs SP4T switches.

10

SWITCHES - SMT

### Electrical Specifications, $T_A = +25^\circ C$ , With 0/+5V Control, 50 Ohm System

Parameter	Frequency	Min.	Typ.	Max.	Units
Insertion Loss	DC - 1.0 GHz		0.6	0.9	dB
	DC - 3.0 GHz		0.7	1.0	dB
	DC - 3.5 GHz		1.0	1.4	dB
	DC - 4.0 GHz		1.4	1.8	dB
Isolation	DC - 1.0 GHz	40	45		dB
	DC - 2.0 GHz	36	40		dB
	DC - 3.0 GHz	30	35		dB
	DC - 4.0 GHz	24	28		dB
Return Loss	"On State"	DC - 3.5 GHz	18		dB
		DC - 4.0 GHz	13		dB
Return Loss	RF 1 - 4 "Off State"	0.2 - 4.0 GHz	10		dB
		0.5 - 4.0 GHz	15		dB
Input Power for 1 dB Compression	0.5 - 4.0 GHz	21	25		dBm
Input Third Order Intercept (Two-Tone Input Power = +7 dBm Each Tone)	0.5 - 3.0 GHz	43	47		dBm
	0.5 - 4.0 GHz	40	43		dBm
Switching Characteristics tRISE, tFALL (10/90% RF) tON, tOFF (50% CTL to 10/90% RF)	DC - 4.0 GHz		40		ns
			150		ns

Information furnished by Analog Devices is believed to be accurate and reliable. However, no responsibility is assumed by Analog Devices for its use, nor for any infringements of patents or other rights of third parties that may result from its use. Specifications subject to change without notice. No license is granted by implication or otherwise under any patent or patent rights of Analog Devices. Trademarks and registered trademarks are the property of their respective owners.

For price, delivery, and to place orders: Analog Devices, Inc., One Technology Way, P.O. Box 9106, Norwood, MA 02062-9106  
Phone: 781-329-4700 • Order online at [www.analog.com](http://www.analog.com)  
Application Support: Phone: 1-800-ANALOG-D

## GaAs MMIC SP4T NON-REFLECTIVE SWITCH, DC - 4 GHz

**Insertion Loss**

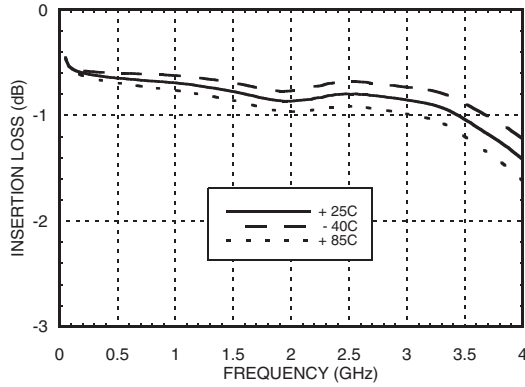

**Isolation**

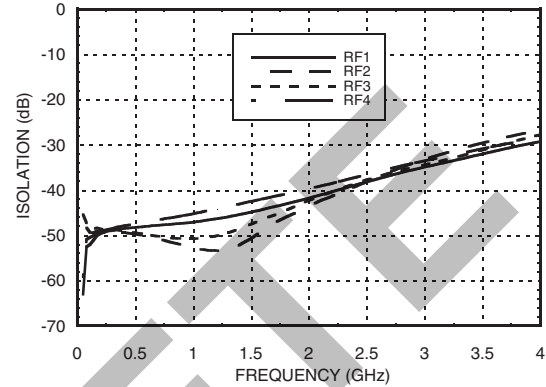

**Return Loss**

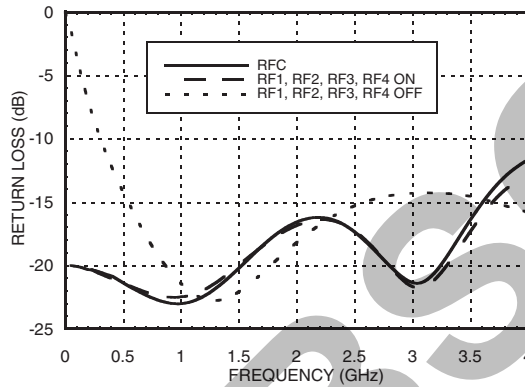

**0.1 and 1 dB Input Compression Point**

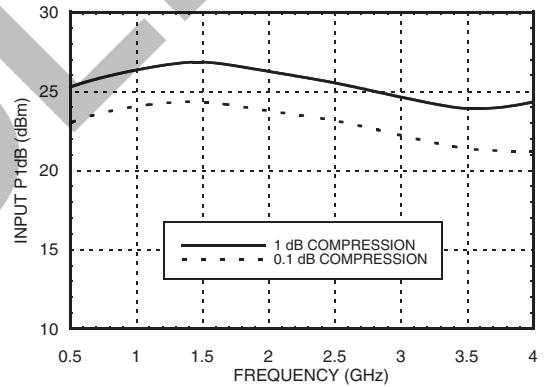

**Input Third Order Intercept Point**

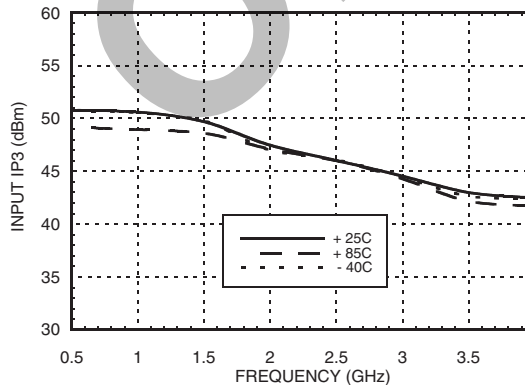

**Bias Voltage & Current**

Vdd Range= +5.0 Vdc ±10%		
Vdd (Vdc)	Idd (Typ) (mA)	Idd (Max) (mA)
+5.0	3.0	7.0

**TTL/CMOS Control Voltages**

State	Bias Condition
Low	0 to +0.8 Vdc @ 5 uA Typ.
High	+2.0 to +5.0 Vdc @ 70 uA Typ.

Information furnished by Analog Devices is believed to be accurate and reliable. However, no responsibility is assumed by Analog Devices for its use, nor for any infringements of patents or other rights of third parties that may result from its use. Specifications subject to change without notice. No license is granted by implication or otherwise under any patent or patent rights of Analog Devices. Trademarks and registered trademarks are the property of their respective owners.

For price, delivery, and to place orders: Analog Devices, Inc., One Technology Way, P.O. Box 9106, Norwood, MA 02062-9106 Phone: 781-329-4700 • Order online at [www.analog.com](http://www.analog.com) Application Support: Phone: 1-800-ANALOG-D

## GaAs MMIC SP4T NON-REFLECTIVE SWITCH, DC - 4 GHz

### Absolute Maximum Ratings

Bias Voltage Range (Port Vdd)	+7.0 Vdc
Control Voltage Range (A & B)	-0.5V to Vdd +1 Vdc
Channel Temperature	150 °C
Thermal Resistance (Insertion Loss Path)	210 °C/W
Thermal Resistance (Terminated Path)	250 °C/W
Storage Temperature	-65 to +150 °C
Operating Temperature	-40 to +85 °C
Maximum Input Power Vdd = +5 Vdc	+20 dBm (0.05 - 0.5 GHz) +27 dBm (0.5 - 3.5 GHz)

### Truth Table

Control Input		Signal Path State
A	B	RF COM to:
Low	Low	RF1
High	Low	RF2
Low	High	RF3
High	High	RF4

10

SWITCHES - SMT



ELECTROSTATIC SENSITIVE DEVICE  
OBSERVE HANDLING PRECAUTIONS

### Outline Drawing

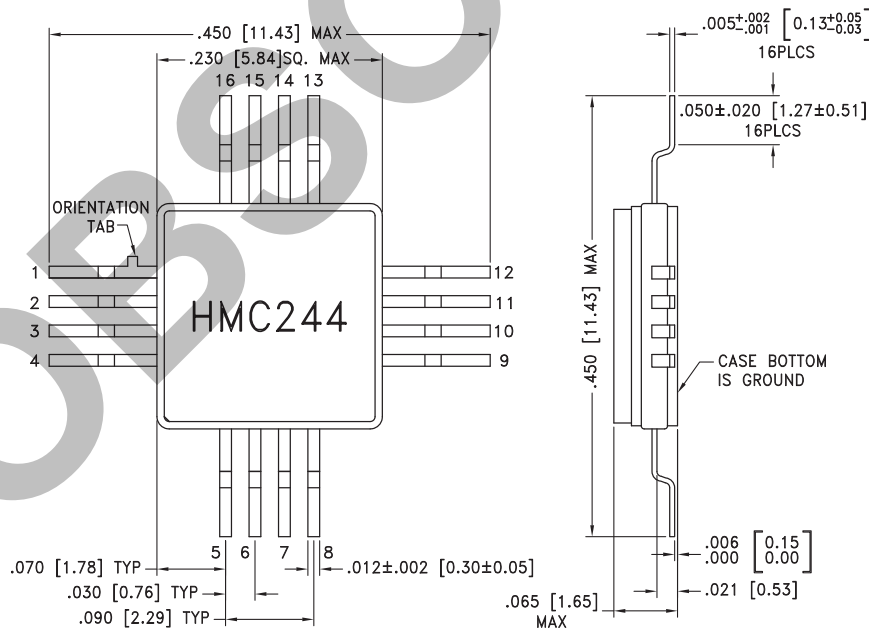

NOTES:

1. PACKAGE MATERIAL: ALUMINA LOADED BOROSILICATE GLASS.
2. LEAD, BASE, COVER MATERIAL: KOVAR™ (#7052 CORNING).
3. PLATING: ELECTROLYTIC GOLD 50 MICROINCHES MIN., OVER ELECTROLYTIC NICKEL 75 MICROINCHES MIN.
4. DIMENSIONS ARE IN INCHES [MILLIMETERS].
5. TOLERANCES: ±.005 [0.13] UNLESS OTHERWISE SPECIFIED.
6. ALL GROUND LEADS AND GROUND PADDLE MUST BE SOLDERED TO PCB RF GROUND.

Information furnished by Analog Devices is believed to be accurate and reliable. However, no responsibility is assumed by Analog Devices for its use, nor for any infringements of patents or other rights of third parties that may result from its use. Specifications subject to change without notice. No license is granted by implication or otherwise under any patent or patent rights of Analog Devices. Trademarks and registered trademarks are the property of their respective owners.

For price, delivery, and to place orders: Analog Devices, Inc., One Technology Way, P.O. Box 9106, Norwood, MA 02062-9106  
Phone: 781-329-4700 • Order online at [www.analog.com](http://www.analog.com)  
Application Support: Phone: 1-800-ANALOG-D

## GaAs MMIC SP4T NON-REFLECTIVE SWITCH, DC - 4 GHz

### Pin Descriptions

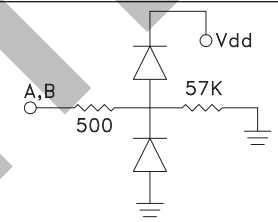
Pin Number	Function	Description	Interface Schematic
1, 3, 5, 10, 12, 13, 14, 16	GND	Package bottom has exposed metal paddle that must also be connected to PCB RF ground.	
2, 4, 9, 11, 15	RF4, RF3, RF2, RF1, RFC	These pins are DC coupled and matched to 50 Ohms. Blocking capacitors are required.	
6	Vdd	Supply Voltage +5.0 Vdc ±10%	
7	B	See truth table and control voltage table.	
8	A	See truth table and control voltage table.	

OBSOLETE

Information furnished by Analog Devices is believed to be accurate and reliable. However, no responsibility is assumed by Analog Devices for its use, nor for any infringements of patents or other rights of third parties that may result from its use. Specifications subject to change without notice. No license is granted by implication or otherwise under any patent or patent rights of Analog Devices. Trademarks and registered trademarks are the property of their respective owners.

For price, delivery, and to place orders: Analog Devices, Inc., One Technology Way, P.O. Box 9106, Norwood, MA 02062-9106 Phone: 781-329-4700 • Order online at [www.analog.com](http://www.analog.com) Application Support: Phone: 1-800-ANALOG-D

**GaAs MMIC SP4T NON-REFLECTIVE  
SWITCH, DC - 4 GHz**

**Evaluation PCB**

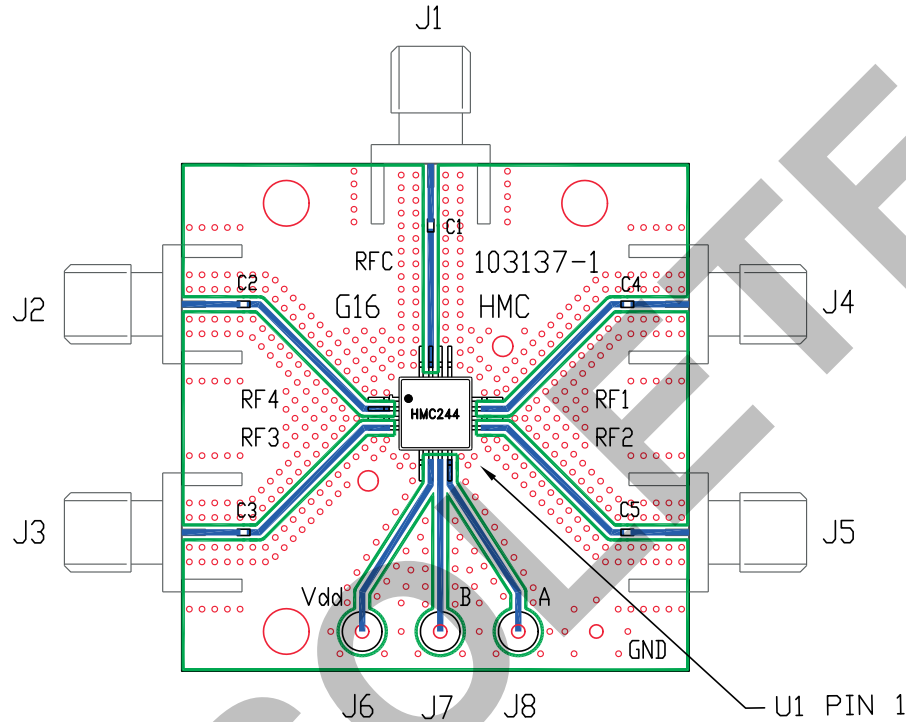

10

SWITCHES - SMT

**List of Materials for Evaluation PCB 104172 [1]**

Item	Description
J1 - J5	PCB Mount SMA RF Connector
J6 - J8	DC Pin
C1 - C5	330 pF Capacitors, 0402 Pkg.
U1	HMC244G16 SP4T Switch
PCB [2]	103137 Evaluation PCB

[1] Reference this number when ordering complete evaluation PCB

[2] Circuit Board Material: Rogers 4350

The circuit board used in the final application should be generated with proper RF circuit design techniques. Signal lines at the RF port should have 50 ohm impedance and the package ground leads and package bottom should be connected directly to the ground plane similar to that shown above. The evaluation circuit board shown above is available from Hittite Microwave Corporation upon request.

**GaAs MMIC SP4T NON-REFLECTIVE  
SWITCH, DC - 4 GHz****Notes:**

**OBSOLETE**