

Noise suppression filter

For audio lines (Cellular band suppression)

MAF series



MAF1608G type



FEATURES

- A compact noise suppression component for audio lines that accommodates high currents.
- Distortions are greatly reduced during insertion with the adoption of newly-developed low distortion ferrite materials.
- Small reductions in volume due to its low resistance, and optimal for devices that require high sound quality as the generating of sound distortions is controlled.
- Shows excellent effects in measures against the deterioration of the receiving sensitivity of wireless devices due to high attenuation characteristics in the cellular band.
- High efficacy is put for high frequency noise suppression of class-D amplifier harmonics.
- Operating temperature range: -55 to +125°C

APPLICATION

- Sound lines for devices such as smartphones and tablets (earphones, microphones, and speakers).
- Sound lines for portable game machines.

PART NUMBER CONSTRUCTION

MAF	1608	G	AD	471	C	T	000
Series name	LxWxT dimensions 1.6x0.8x0.6 mm 1.6x0.8x0.8 mm	Characteristics	Internal code	Impedance (Ω) at 900MHz	Internal code	Packaging style	Internal code

CHARACTERISTICS SPECIFICATION TABLE

Impedance		DC resistance		Rated current*	Thickness	Part No.		
[100MHz]	[900MHz]	[1.7GHz]						
(Ω)Typ.	(Ω)Typ.	(Ω)min.	(Ω)Typ.	(Ω)Typ.	(Ω)max.	(A)max.		
20	120	72	90	0.021	0.027	3.2	0.75	MAF1608GAD121LTAH0
30	200	120	160	0.045	0.059	2.3	0.75	MAF1608GAD201LTAH0
60	470	290	350	0.060	0.075	1.6	0.75	MAF1608GAD471LTAH0
60	470	290	270	0.060	0.075	1.6	0.95	MAF1608GAD471CT000
120	600	400	270	0.110	0.150	1.0	0.95	MAF1608GAD601CT000

*Please refer to the graph of rated current vs. temperature characteristics (derating) about the rating current at 85°C or more in temperature of the product.

Measurement equipment

Measurement item	Product No.	Manufacturer
Impedance	E4991A+16192A	Keysight Technologies
DC resistance	Type-7556	Yokogawa

* Equivalent measurement equipment may be used.

Rated current vs. temperature characteristics (derating)

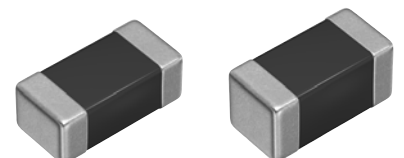
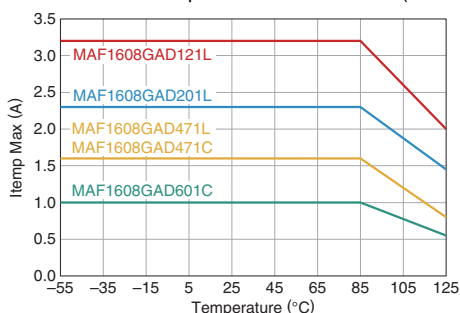

⚠ Please be sure to request delivery specifications that provide further details on the features and specifications of the products for proper and safe use. (1/4)
Please note that the contents may change without any prior notice due to reasons such as upgrading.

20190830

suppression-filter_commercial_maf1608g_en

MAF1608G type

Z VS. FREQUENCY CHARACTERISTICS

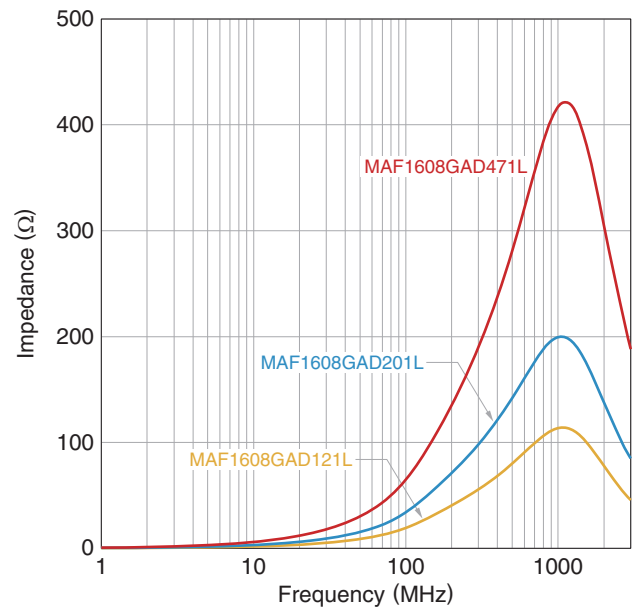
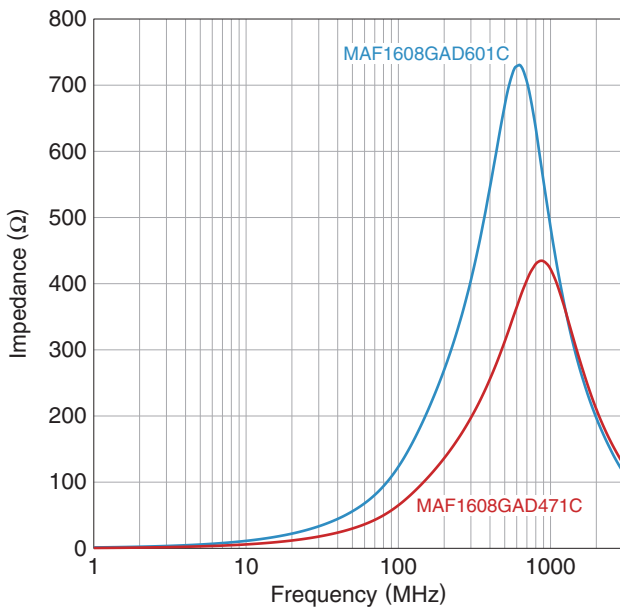

INSERTION LOSS VS. FREQUENCY CHARACTERISTICS

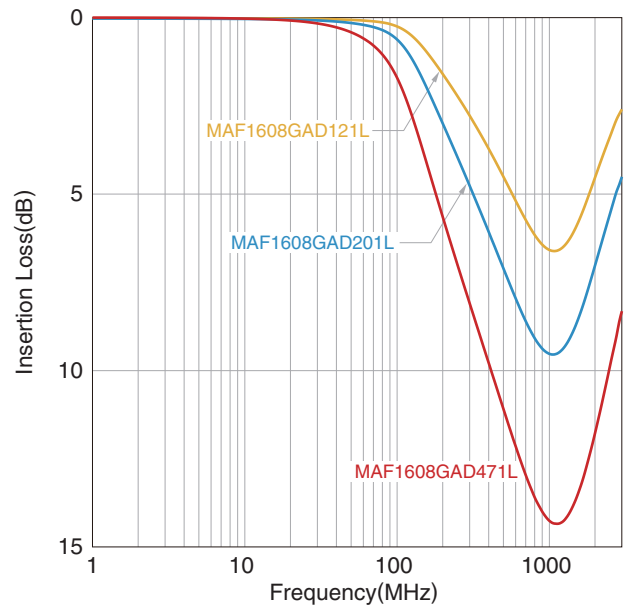
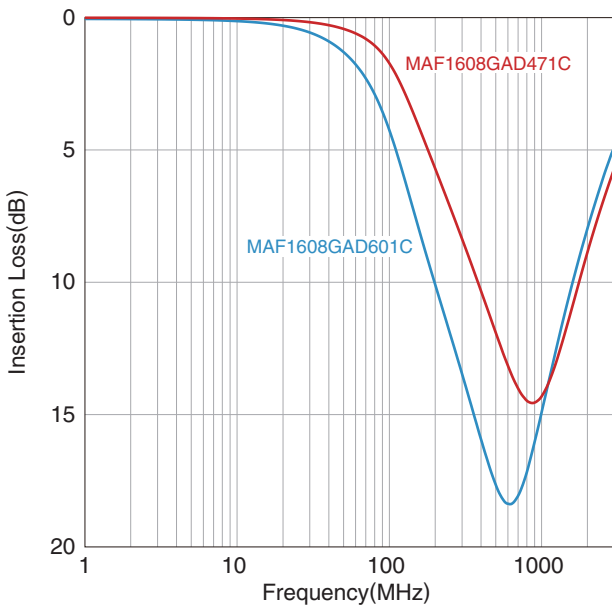

MAF1608G type

SHAPE & DIMENSIONS

t=0.75mm

t=0.95mm

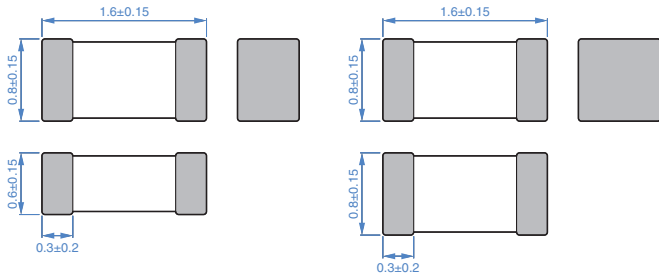

Dimensions in mm

PACKAGING STYLE

REEL DIMENSIONS

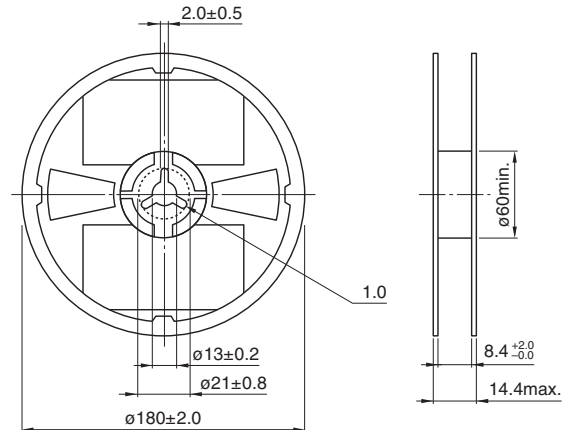

Dimensions in mm

RECOMMENDED LAND PATTERN

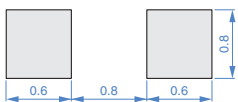

Dimensions in mm

TAPE DIMENSIONS

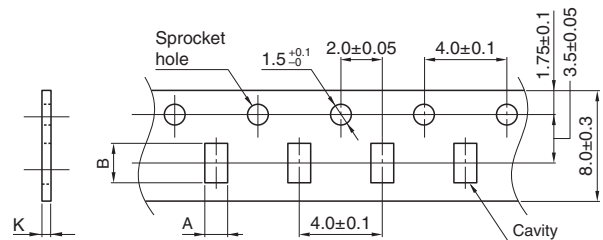

Dimensions in mm

Type	A	B	K
MAF1608G	1.1±0.2	1.9±0.2	1.1max.

RECOMMENDED REFLOW PROFILE

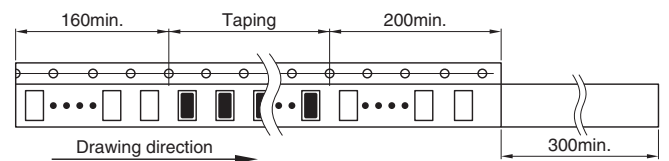
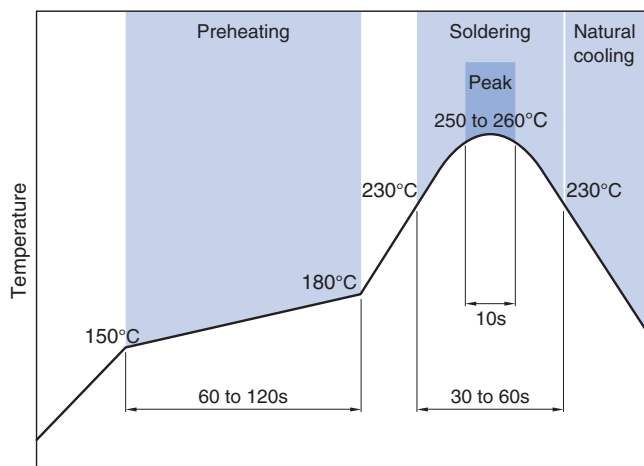

Dimensions in mm

PACKAGE QUANTITY

Package quantity	4,000 pcs/reel
------------------	----------------

TEMPERATURE RANGE, INDIVIDUAL WEIGHT

Type	Operating temperature range	Storage temperature range*	Individual weight
t=0.75mm	-55 to +125 °C	-55 to +125 °C	3 mg
t=0.95mm	-55 to +125 °C	-55 to +125 °C	4 mg

* The storage temperature range is for after the assembly.

REMINDERS FOR USING THESE PRODUCTS

Before using these products, be sure to request the delivery specifications.

SAFETY REMINDERS

Please pay sufficient attention to the warnings for safe designing when using this products.

REMINDERS

- The storage period is within 12 months. Be sure to follow the storage conditions (temperature: 5 to 40°C, humidity: 10 to 75% RH or less).
If the storage period elapses, the soldering of the terminal electrodes may deteriorate.
- Do not use or store in locations where there are conditions such as gas corrosion (salt, acid, alkali, etc.).
- Before soldering, be sure to preheat components.
The preheating temperature should be set so that the temperature difference between the solder temperature and chip temperature does not exceed 150°C.
- Soldering corrections after mounting should be within the range of the conditions determined in the specifications.
If overheated, a short circuit, performance deterioration, or lifespan shortening may occur.
- When embedding a printed circuit board where a chip is mounted to a set, be sure that residual stress is not given to the chip due to the overall distortion of the printed circuit board and partial distortion such as at screw tightening portions.
- Self heating (temperature increase) occurs when the power is turned ON, so the tolerance should be sufficient for the set thermal design.
- Carefully lay out the coil for the circuit board design of the non-magnetic shield type.
A malfunction may occur due to magnetic interference.
- Use a wrist band to discharge static electricity in your body through the grounding wire.
- Do not expose the products to magnets or magnetic fields.
- Do not use for a purpose outside of the contents regulated in the delivery specifications.
- The products listed on this catalog are intended for use in general electronic equipment (AV equipment, telecommunications equipment, home appliances, amusement equipment, computer equipment, personal equipment, office equipment, measurement equipment, industrial robots) under a normal operation and use condition.
The products are not designed or warranted to meet the requirements of the applications listed below, whose performance and/or quality require a more stringent level of safety or reliability, or whose failure, malfunction or trouble could cause serious damage to society, person or property.
If you intend to use the products in the applications listed below or if you have special requirements exceeding the range or conditions set forth in the each catalog, please contact us.

- (1) Aerospace/aviation equipment
- (2) Transportation equipment (cars, electric trains, ships, etc.)
- (3) Medical equipment
- (4) Power-generation control equipment
- (5) Atomic energy-related equipment
- (6) Seabed equipment
- (7) Transportation control equipment

- (8) Public information-processing equipment
- (9) Military equipment
- (10) Electric heating apparatus, burning equipment
- (11) Disaster prevention/crime prevention equipment
- (12) Safety equipment
- (13) Other applications that are not considered general-purpose applications

When designing your equipment even for general-purpose applications, you are kindly requested to take into consideration securing protection circuit/device or providing backup circuits in your equipment.