

High Speed, Precision, JFET Input Instrumentation Amplifier (Fixed Gain = 10 or 100)

FEATURES

- Slew Rate: 30V/μs
- Gain-Bandwidth Product: 35MHz
- Settling Time (0.01%): 3μs
- Overdrive Recovery: 0.4μs
- Gain Error: 0.05% Max
- Gain Drift: 5ppm/°C
- Gain Nonlinearity: 16ppm Max
- Offset Voltage (Input + Output): 600μV Max
– Drift with Temperature: 2μV/°C
- Input Bias Current: 40pA Max
- Input Offset Current: 40pA Max
– Drift with Temperature (to 70°C): 0.5pA/°C

APPLICATIONS

- Fast Settling Analog Signal Processing
- Multiplexed Input Data Acquisition Systems
- High Source Impedance Signal Amplification from High Resistance Bridges, Capacitance Sensors, Photodetector Sensors
- Bridge Amplifier with < 1Hz Lowpass Filtering

DESCRIPTION

The LT[®]1102 is the first fast FET input instrumentation amplifier offered in the low cost, space saving 8-pin packages. Fixed gains of 10 and 100 are provided with excellent gain accuracy (0.01%) and non-linearity (3ppm). No external gain setting resistor is required.

Slew rate, settling time, gain-bandwidth product, overdrive recovery time are all improved compared to competitive high speed instrumentation amplifiers.

Industry best speed performance is combined with impressive precision specifications: less than 10pA input bias and offset currents, 180μV offset voltage. Unlike other FET input instrumentation amplifiers, on the LT1102 there is no output offset voltage contribution to total error, and input bias currents do not double with every 10°C rise in temperature. Indeed, at 70°C ambient temperature the input bias current is only 40pA.

LT, LT, LTC and LTM are registered trademarks of Linear Technology Corporation.

TYPICAL APPLICATION

**Wideband Instrumentation Amplifier
with ±150mA Output Current**

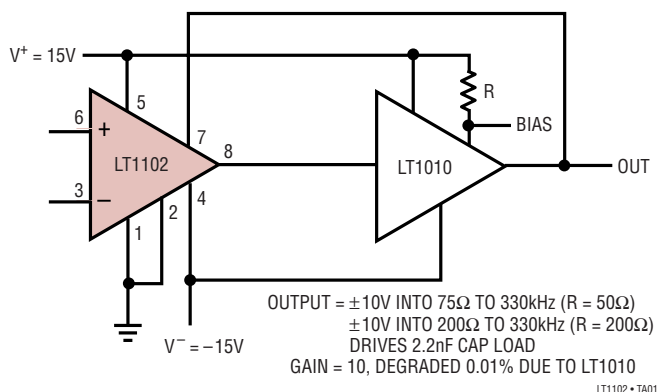

Slew Rate

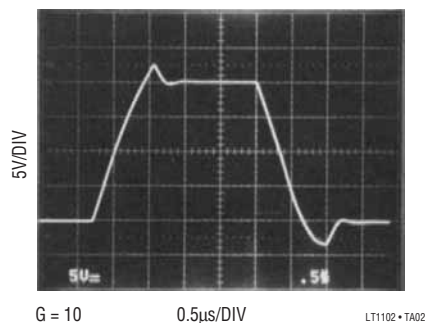

LT1102

ABSOLUTE MAXIMUM RATINGS (Note 1)

Supply Voltage $\pm 20V$
 Differential Input Voltage $\pm 40V$
 Input Voltage $\pm 20V$

Output Short-Circuit Duration Indefinite
 Operating Temperature Range
 LT1102I $-40^{\circ}C$ to $85^{\circ}C$
 LT1102AC/LT1102C $0^{\circ}C$ to $70^{\circ}C$
 LT1102AM/LT1102M (**OBSOLETE**) $-55^{\circ}C$ to $125^{\circ}C$
 Storage Temperature Range $-65^{\circ}C$ to $150^{\circ}C$
 Lead Temperature (Soldering, 10 sec) $300^{\circ}C$

Order Options Tape and Reel: Add #TR
 Lead Free: Add #PBF Lead Free Tape and Reel: Add #TRPBF
 Lead Free Part Marking: <http://www.linear.com/leadfree/>

PACKAGE/ORDER INFORMATION

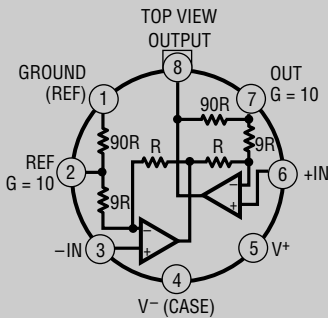
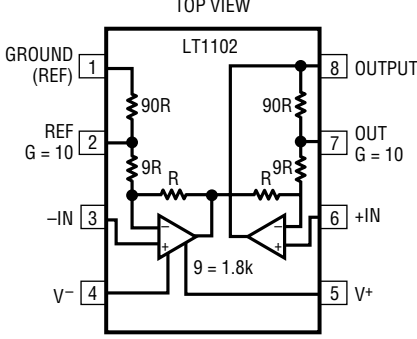
 <p>H PACKAGE 8-LEAD TO-5 METAL CAN</p> <p>OBSOLETE PACKAGE Consider the N8 Package for Alternate Source</p>	<p>ORDER PART NUMBER</p> <p>LT1102AMH LT1102MH LT1102ACH LT1102CH</p>	 <p>N8 PACKAGE 8-LEAD PDIP</p> <p>$T_{JMAX} = 100^{\circ}C$, $\theta_{JA} = 130^{\circ}C/W$</p> <p>J8 PACKAGE 8-LEAD CERDIP</p> <p>OBSOLETE PACKAGE Consider the N8 Package for Alternate Source</p>	<p>ORDER PART NUMBER</p> <p>LT1102IN8 LT1102ACN8 LT1102CN8</p> <p>LT1102MJ8 LT1102CJ8</p> <p style="text-align: right;"><small>LT1102 • P0101</small></p>
---	---	--	---

Consult LTC Marketing for parts specified with wider operating temperature ranges.

ELECTRICAL CHARACTERISTICS $V_S = \pm 15V, V_{CM} = 0V, T_A = 25^\circ C, \text{Gain} = 10 \text{ or } 100, \text{ unless otherwise noted.}$

SYMBOL	PARAMETER	CONDITIONS	LT1102AM/AC			LT1102M/I/C			UNITS
			MIN	TYP	MAX	MIN	TYP	MAX	
G_E	Gain Error	$V_O = \pm 10V, R_L = 50k \text{ or } 2k$		0.010	0.050		0.012	0.070	%
G_{NL}	Gain Nonlinearity	$G = 100, R_L = 50k$		3	14		4	18	ppm
		$G = 100, R_L = 2k$		8	20		8	25	ppm
		$G = 10, R_L = 50k \text{ or } 2k$		7	16		7	30	ppm
V_{OS}	Input Offset Voltage			180	600		200	900	μV
I_{OS}	Input Offset Current			3	40		4	60	μA
I_B	Input Bias Current			± 3	± 40		± 4	± 60	μA
	Input Resistance Common Mode	$V_{CM} = -11V \text{ to } 8V$		10^{12}			10^{12}		Ω
	Differential Mode	$V_{CM} = 8V \text{ to } 11V$		10^{11}			10^{11}		Ω
				10^{12}			10^{12}		Ω
e_n	Input Noise Voltage	0.1Hz to 10Hz		2.8			2.8		μV_{P-P}
	Input Noise Voltage Density	$f_0 = 10Hz$ $f_0 = 1000Hz$ (Note 2)		37	30		37	20	nV/\sqrt{Hz} nV/\sqrt{Hz}
	Input Noise Current Density	$f_0 = 1000Hz, 10Hz$ (Note 3)		1.5	4		2	5	fA/\sqrt{Hz}
	Input Voltage Range		± 10.5	± 11.5		± 10.5	± 11.5		V
CMRR	Common Mode Rejection Ratio	1k Source Imbalance, $V_{CM} = \pm 10.5V$	84	98		82	97		dB
PSRR	Power Supply Rejection Ratio	$V_S = \pm 9V \text{ to } \pm 18V$	88	102		86	101		dB
I_S	Supply Current			3.3	5.0		3.4	5.6	mA
V_O	Maximum Output Voltage Swing	$R_L = 50k$	± 13.0	± 13.5		± 13.0	± 13.5		V
		$R_L = 2k$	± 12.0	± 13.0		± 12.0	± 13.0		V
BW	Bandwidth	$G = 100$ (Note 4)	120	220		100	220		kHz
		$G = 10$ (Note 4)	2.0	3.5		1.7	3.5		MHz
SR	Slew Rate	$G = 100, V_{IN} = \pm 0.13V, V_O = \pm 5V$	12	17		10	17		$V/\mu s$
		$G = 10, V_{IN} = \pm 1V, V_O = \pm 5V$	21	30		18	30		$V/\mu s$
	Overdrive Recovery	50% Overdrive (Note 5)		400			400		ns
	Settling Time	$V_O = 20V$ Step (Note 4)							
		$G = 10$ to 0.05%		1.8	4.0		1.8	4.0	μs
		$G = 10$ to 0.01%		3.0	6.5		3.0	6.5	μs
		$G = 100$ to 0.05%		7	13		7	13	μs
		$G = 100$ to 0.01%		9	18		9	18	μs

ELECTRICAL CHARACTERISTICS $V_S = \pm 15V, V_{CM} = 0V, \text{Gain} = 10 \text{ or } 100, -55^\circ\text{C} \leq T_A \leq 125^\circ\text{C}$ for AM/M grades, $-40^\circ\text{C} \leq T_A \leq 85^\circ\text{C}$ for I grades, unless otherwise noted.

SYMBOL	PARAMETER	CONDITIONS	LT1102AM			LT1102M/I			UNITS
			MIN	TYP	MAX	MIN	TYP	MAX	
G_E	Gain Error	$G = 100, V_O = \pm 10V, R_L = 50k \text{ or } 2k$ $G = 10, V_O = \pm 10V, R_L = 50k \text{ or } 2k$	0.10	0.25		0.10	0.30		%
			0.05	0.12		0.06	0.15		%
TCG_E	Gain Error Drift (Note 6)	$G = 100, R_L = 50k \text{ or } 2k$ $G = 10, R_L = 50k \text{ or } 2k$	9	20		10	25		ppm/ $^\circ\text{C}$
			5	10		6	14		ppm/ $^\circ\text{C}$
G_{NL}	Gain Nonlinearity	$G = 100, R_L = 50k$ $G = 100, R_L = 2k$ $G = 10, R_L = 50k \text{ or } 2k$	20	70		24	90		ppm
			28	85		32	110		ppm
			9	20		9	24		ppm
V_{OS}	Input Offset Voltage		300	1400		400	2000		μV
$\Delta V_{OS}/\Delta T$	Input Offset Voltage Drift	(Note 6)	2	8		3	12		$\mu\text{V}/^\circ\text{C}$
I_{OS}	Input Offset Current		0.3	4		0.4	6		nA
I_B	Input Bias Current		± 2	± 10		± 2.5	± 15		nA
CMRR	Common Mode Rejection Ratio	$V_{CM} = \pm 10.3V$	82	97		80	96		dB
PSRR	Power Supply Rejection Ratio	$V_S = \pm 10V \text{ to } \pm 17V$	88	100		84	99		dB
I_S	Supply Current	$T_A = 125^\circ\text{C}$		2.5			2.5		mA
V_O	Maximal Output Voltage Swing	$R_L = 50k$ $R_L = 2k$	± 12.5	± 13.2		± 12.5	± 13.2		V
			± 12.0	± 12.6		± 12.0	± 12.6		V

$V_S = \pm 15V, V_{CM} = 0V, \text{Gain} = 10 \text{ or } 100, 0^\circ\text{C} \leq T_A \leq 70^\circ\text{C}$, unless otherwise noted.

SYMBOL	PARAMETER	CONDITIONS	LT1102AC			LT1102C			UNITS
			MIN	TYP	MAX	MIN	TYP	MAX	
G_E	Gain Error	$G = 100, V_O = \pm 10V, R_L = 50k \text{ or } 2k$ $G = 10, V_O = \pm 10V, R_L = 50k \text{ or } 2k$	0.04	0.11		0.05	0.14		%
			0.03	0.09		0.04	0.12		%
TCG_E	Gain Error Drift (Note 6)	$G = 100, R_L = 50k \text{ or } 2k$ $G = 10, R_L = 50k \text{ or } 2k$	8	18		9	22		ppm/ $^\circ\text{C}$
			5	10		6	14		ppm/ $^\circ\text{C}$
G_{NL}	Gain Nonlinearity	$G = 100, R_L = 50k$ $G = 100, R_L = 2k$ $G = 10, R_L = 50k \text{ or } 2k$	8	30		9	40		ppm
			11	36		12	48		ppm
			8	18		8	22		ppm
V_{OS}	Input Offset Voltage		230	1000		280	1400		μV
$\Delta V_{OS}/\Delta T$	Input Offset Voltage Drift	(Note 6)	2	8		3	12		$\mu\text{V}/^\circ\text{C}$
I_{OS}	Input Offset Current		10	150		15	220		pA
$\Delta I_{OS}/\Delta T$	Input Offset Current Drift	(Note 6)	0.5	3		0.5	4		pA/ $^\circ\text{C}$
I_B	Input Bias Current		± 40	± 300		± 50	± 400		pA
$\Delta I_B/\Delta T$	Input Bias Current Drift	(Note 6)	1	4		1	6		pA/ $^\circ\text{C}$
CMRR	Common Mode Rejection Ratio	$V_{CM} = \pm 10.3V$	83	98		81	97		dB
PSRR	Power Supply Rejection Ratio	$V_S = \pm 10V \text{ to } \pm 17V$	87	101		85	100		dB
I_S	Supply Current	$T_A = 70^\circ\text{C}$		2.8			2.9		mA
V_O	Maximum Output Voltage Swing	$R_L = 50k$ $R_L = 2k$	± 12.8	± 13.4		± 12.8	± 13.4		V
			± 12.0	± 12.8		± 12.0	± 12.8		V

ELECTRICAL CHARACTERISTICS

Note 1: Stresses beyond those listed under Absolute Maximum Ratings may cause permanent damage to the device. Exposure to any Absolute Maximum Rating condition for extended periods may affect device reliability and lifetime.

Note 2: This parameter is tested on a sample basis only.

Note 3: Current noise is calculated from the formula:

$$i_n = (2qI_B)^{1/2}$$

where $q = 1.6 \cdot 10^{-19}$ coulomb. The noise of source resistors up to $1G\Omega$ swamps the contribution of current noise.

Note 4: This parameter is not tested. It is guaranteed by design and by inference from the slew rate measurement.

Note 5: Overdrive recovery is defined as the time delay from the removal of an input overdrive to the output's return from saturation to linear operation.

50% overdrive equals $V_{IN} = \pm 2V$ ($G = 10$) or $V_{IN} = \pm 200mV$ ($G = 100$).

Note 6: This parameter is not tested. It is guaranteed by design and by inference from other tests.

TYPICAL PERFORMANCE CHARACTERISTICS

Small Signal Response, $G = 10$
(Input = 50mV Pulse)

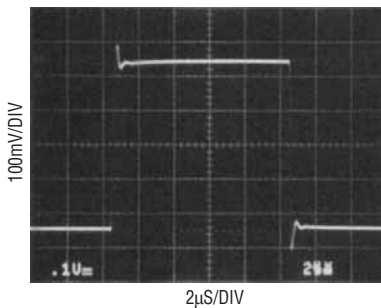

Small Signal Response, $G = 100$
(Input = 5mV Pulse)

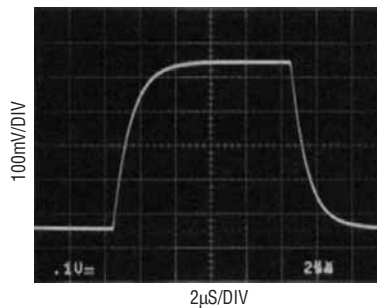

Slew Rate, $G = 100$
(Input = ±130mV Pulse)

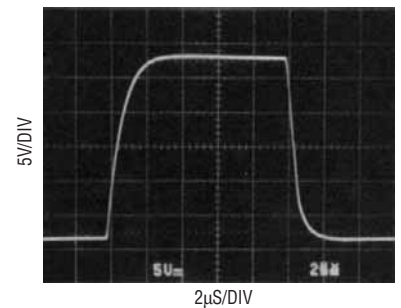

Settling Time, $G = 10$
(Input From -10V to 10V)

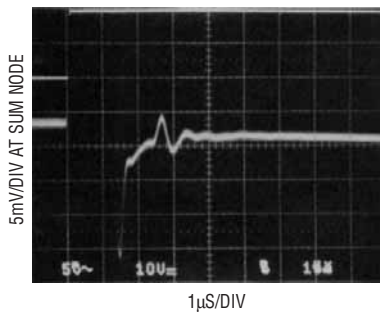

Settling Time, $G = 10$
(Input From 10V to -10V)

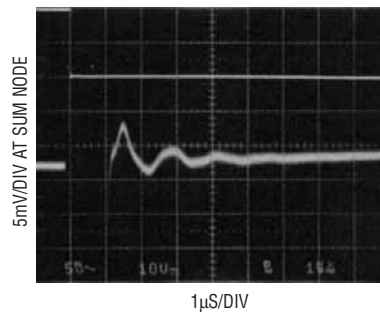

Settling Time, $G = 100$
(Input From -10V to 10V)

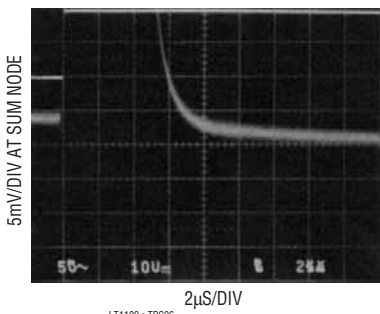

Settling Time, $G = 100$
(Input From 10V to -10V)

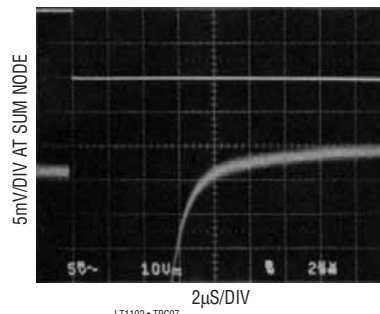

TYPICAL PERFORMANCE CHARACTERISTICS

Capacitive Load Handling

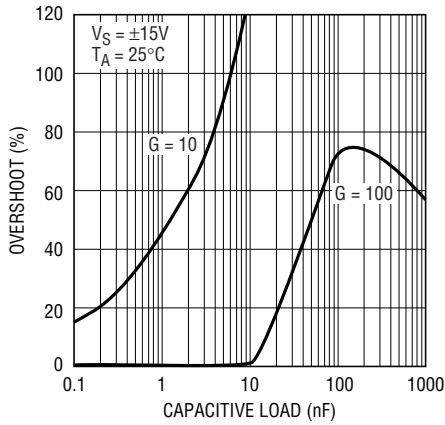

LT1102 • TPC08

Output Impedance vs Frequency

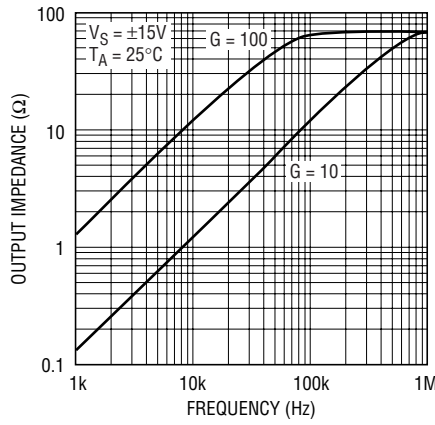

LT1102 • TPC09

Gain vs Frequency

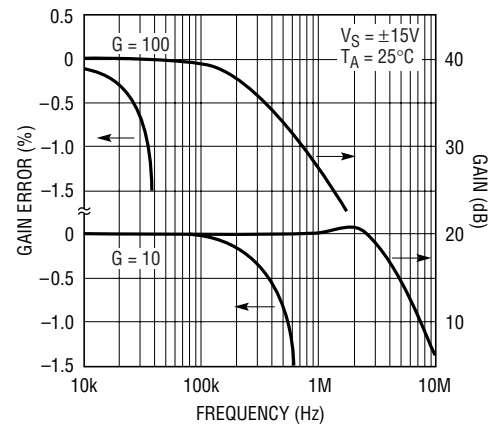

LT1102 • TPC10

Undistorted Output vs Frequency

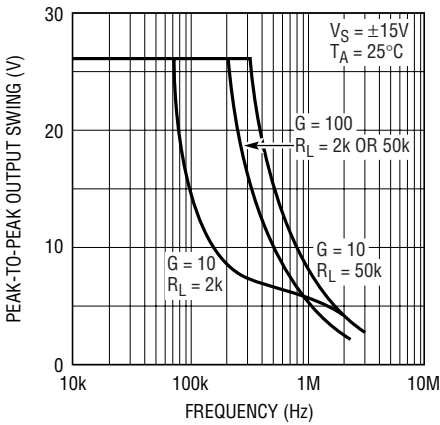

LT1102 • TPC11

Voltage Noise vs Frequency

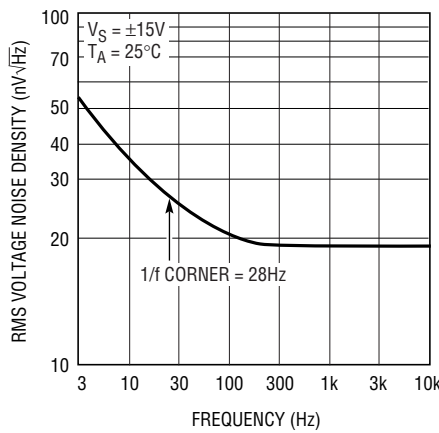

LT1102 • TPC12

Input Bias Current Over the Common Mode Range

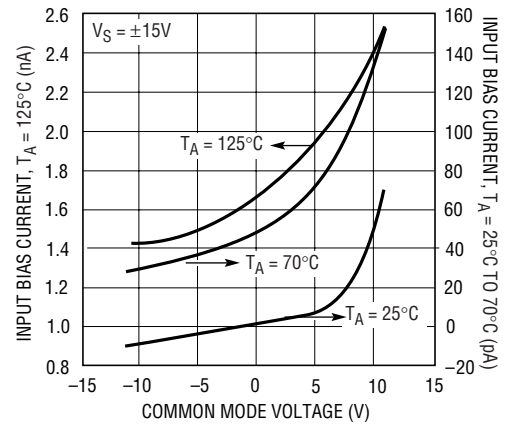

LT1102 • TPC13

Warm-Up Drift

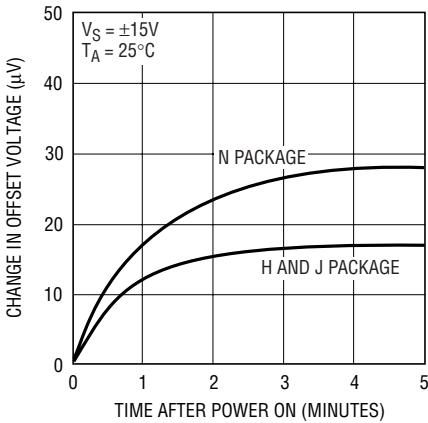

LT1102 • TPC14

Common Mode Range vs Temperature

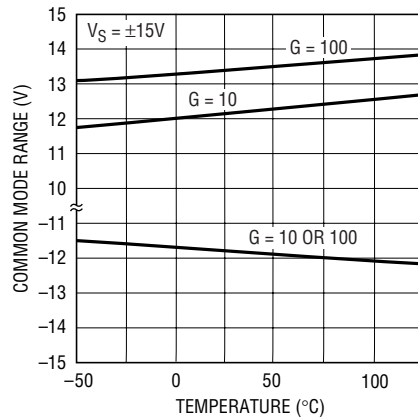

LT1102 • TPC15

Supply Current vs Temperature

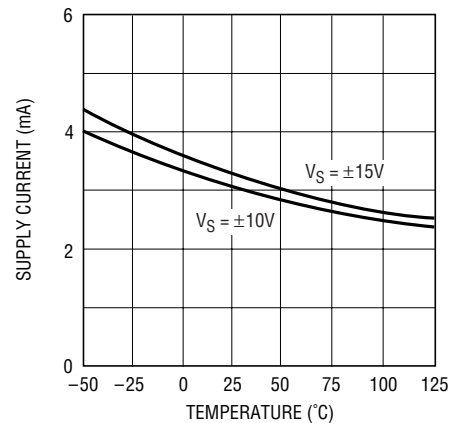

LT1102 • TPC16

TYPICAL PERFORMANCE CHARACTERISTICS

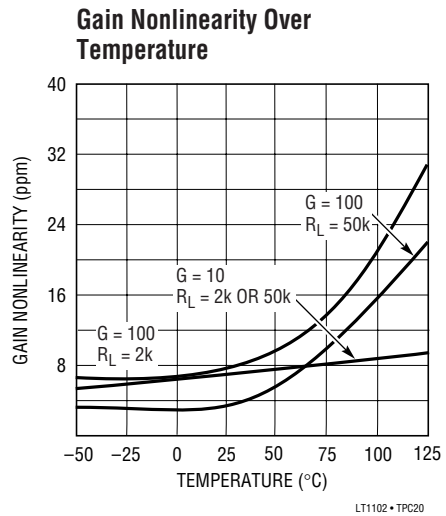
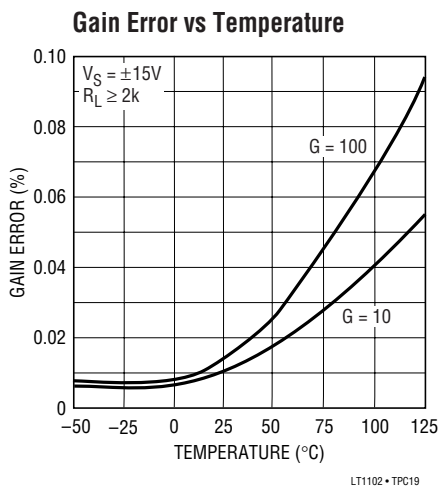
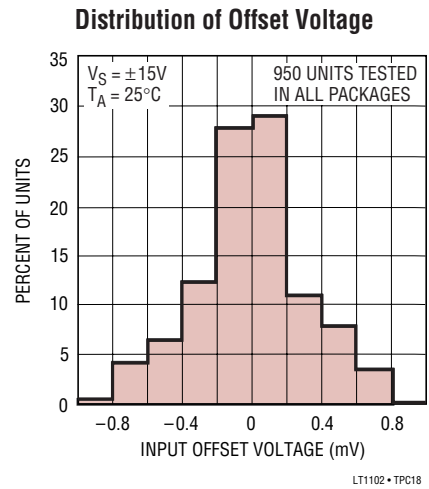
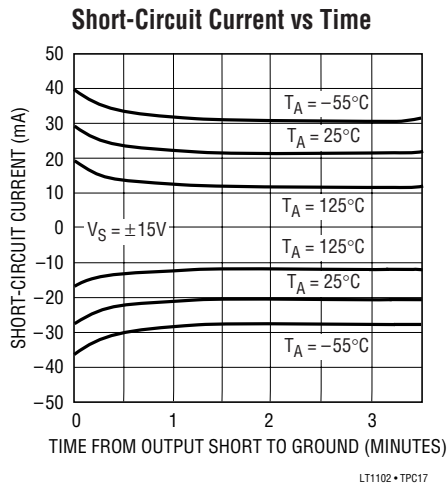

APPLICATIONS INFORMATION

In the two op amp instrumentation amplifier configuration, the first amplifier is basically in unity gain, and the second amplifier provides all the voltage gain. In the LT1102, the second amplifier is decompensated for gain of 10 stability, therefore high slew rate and bandwidth are achieved. Common mode rejection versus frequency is also optimized in the G = 10 mode, because the bandwidths of the two op amps are similar. When G = 100, this statement is no longer true; however, by connecting an 18pF capacitor between pins 1 and 2, a common mode AC gain is created to cancel the inherent roll-off. From 200Hz to 30kHz, CMRR versus frequency is improved by an order of magnitude.

Input Protection

Instrumentation amplifiers are often used in harsh environments where overload conditions can occur. The LT1102 employs FET input transistors, consequently the differential input voltage can be ±30V (with ±15V supplies, ±36V with ±18V supplies). Some competitive instrumentation amplifiers have NPN inputs which are protected by back-to-back diodes. When the differential input Voltage exceeds ±13V on these competitive devices, input current increases to milliampere level; more than ±10V differential voltage can cause permanent damage.

When the LT1102 inputs are pulled below the negative supply or above the positive supply, the inputs will clamp a diode voltage below or above the supplies. No damage will occur if the input current is limited to 20mA.

Common Mode Rejection Ratio vs Frequency

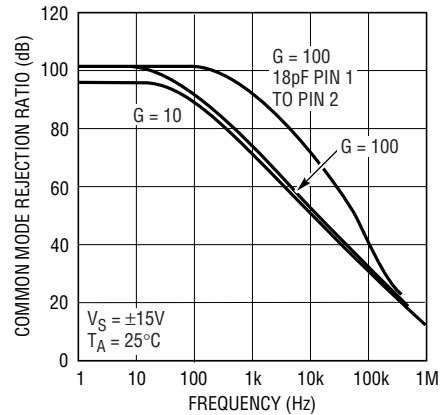

LT1102 • A101

Gains Between 10 and 100

Gains between 10 and 100 can be achieved by connecting two equal resistors (= R_X) between pins 1 and 2 and pins 7 and 8.

$$\text{Gain} = 10 + \frac{R_X}{R + R_X/90}$$

The nominal value of R is 1.84kΩ. The usefulness of this method is limited by the fact that R is not controlled to better than ±10% absolute accuracy in production. However, on any specific unit, 90R can be measured between Pins 1 and 2.

APPLICATIONS INFORMATION

Gain = 20, 110, or 200 Instrumentation Amplifiers

Differential Output

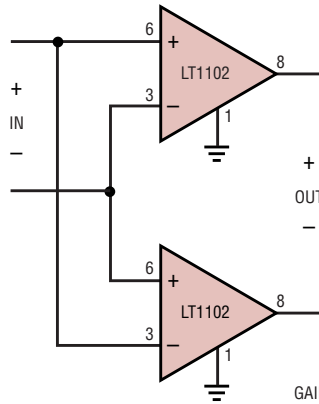

Single Ended Output

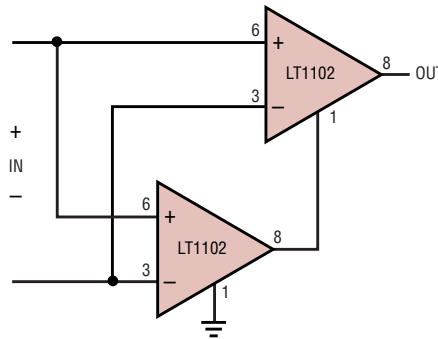

GAIN = 200, AS SHOWN
 GAIN = 20, SHORT PIN 1 TO PIN 2, PIN 7 TO PIN 8 ON BOTH DEVICES
 GAIN = 110, SHORT PIN 1 TO PIN 2, PIN 7 TO PIN 8 ON ONE DEVICE,
 NOT ON THE OTHER
 INPUT REFERRED NOISE IS REDUCED BY $\sqrt{2}$ (G = 200 OR 20)

LT1102 • AI02

Multiplexed Input Data Acquisition

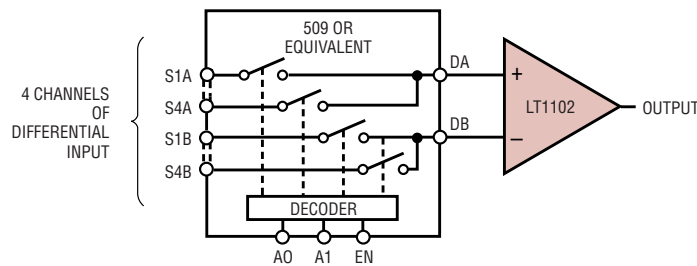

800kHz SIGNALS CAN BE MULTIPLEXED WITH LT1102 IN G = 10

LT1102 • AI03

Voltage Programmable Current Source is Simple and Precise

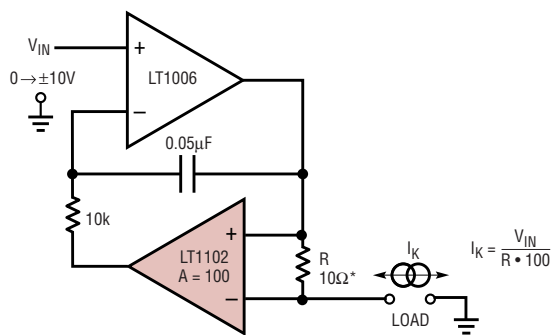

LT1102 • AI04

Dynamic Response of the Current Source

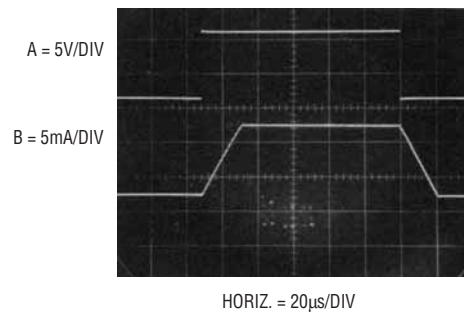

LT1102 • AI05

TYPICAL APPLICATIONS

Basic Connections

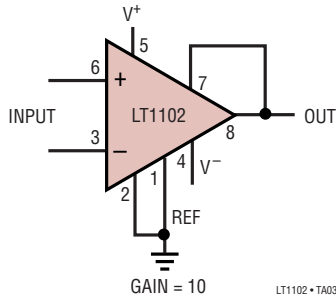
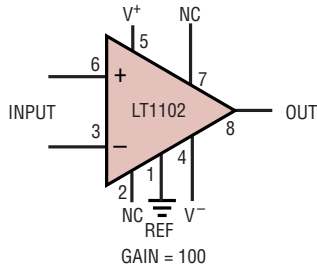

Settling Time Test Circuit

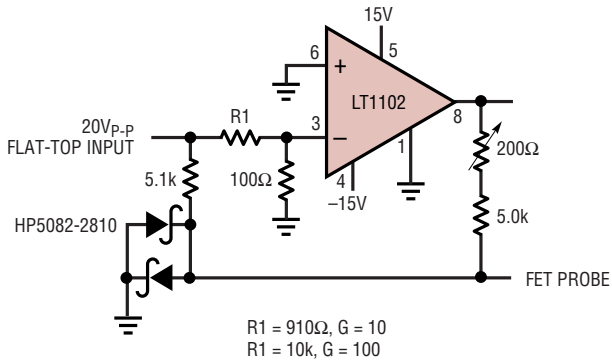

Offset Nulling

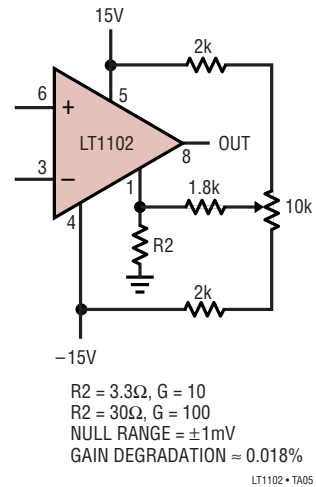

PACKAGE DESCRIPTION

N8 Package
8-Lead PDIP (Narrow .300 Inch)
 (Reference LTC DWG # 05-08-1510)

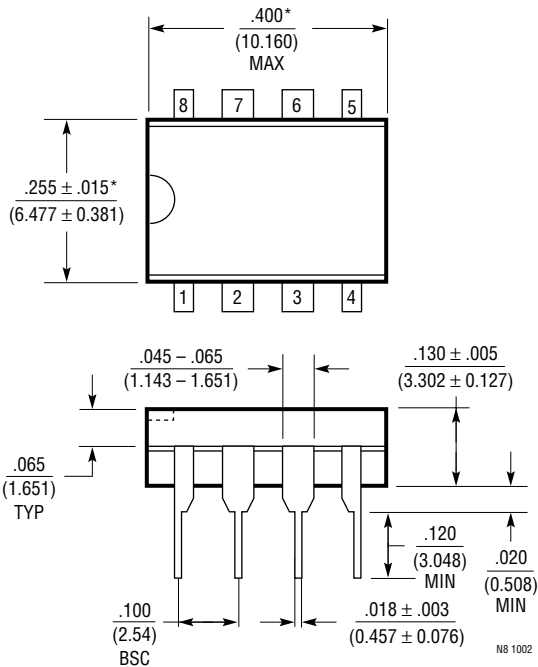

NOTE:
 1. DIMENSIONS ARE $\frac{\text{INCHES}}{\text{MILLIMETERS}}$
 *THESE DIMENSIONS DO NOT INCLUDE MOLD FLASH OR PROTRUSIONS.
 MOLD FLASH OR PROTRUSIONS SHALL NOT EXCEED .010 INCH (0.254mm)