

T-06/T-03 Series Switches

Compact general-purpose snap switch with a depth of 18.6 mm

φ12

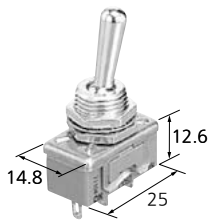

(Unit: mm)

FEATURES

- Depth of 18.6 mm saves space

*These switches are only for Industrial use.
Do not use any other applications. (ex. home use)

ORDERING INFORMATION (PART NO.)

WD1

1 F

- Number of pole and operation
0: 1-pole, single throw (ON-OFF)
1: 1-pole, double throw (ON-ON)
2: 2-pole, single throw (ON-OFF)
3: 2-pole, double throw (ON-ON)
- Rating, Terminal
5: 6 A Snap, Soldering terminal
6: 3 A Snap, Soldering terminal
- Kind of operation
1: ON-OFF, ON-ON
- F: Cadmium-free product

TYPES

T-06 series snap switches

Number of poles	Kind of operation	Solder terminal	
		Type No.	Part No.
1-pole	ON-OFF	T106A-F	WD1051F
	ON-ON	T106D-F	WD1151F
2-pole	ON-OFF	T206K-F	WD1251F
	ON-ON	T206N-F	WD1351F

Note: The product comes with standard installation accessories. However, keying washer is sold separately.

T-03 series snap switches

Number of poles	Kind of operation	Solder terminal	
		Type No.	Part No.
1-pole	ON-OFF	T103A-F	WD1061F
	ON-ON	T103D-F	WD1161F
2-pole	ON-OFF	T203K-F	WD1261F
	ON-ON	T203N-F	WD1361F

Note: The product comes with standard installation accessories. However, keying washer is sold separately.

T-06/T-03 Series Switches (WD1)

RATING

Contact rating

Kind of load	T-06 series snap switches (Part No. WD1*51)	T-03 series snap switches (Part No. WD1*61)
Resistive load	6 A 125 V AC 6 A 30 V DC 3 A 250 V AC	3 A 125 V AC 2 A 250 V AC
Inductive load	6 A 125 V AC (Power factor: 0.6), 3 A 250 V AC (Power factor: 0.6)	3 A 125 V AC (Power factor: 0.6), 2 A 250 V AC (Power factor: 0.6)
Motor load	100 W 125 V AC 100 W 250 V AC	—

Specifications

Item	Specifications
Mechanical life	Min. 5×10^4
Electrical life	T-06 series snap switches: Min. 3×10^4 (10 cpm) (at rated load) T-03 series snap switches: Min. 10^4 (10 cpm) (at rated load)
Overload life	Min. 50 (5 cpm) (Rated load \times 1.5)
Insulation resistance	Min. 100 M Ω (at 500 V DC measured by insulation resistive meter)
Dielectric strength	1500 Vrms for 1 min (at detection current: 10mA)
Vibration resistance	10 to 55 Hz at double amplitude of 1.5 mm (contact opening: Max. 1 ms)
Contact resistance	Initial, Max. 20 m Ω (by voltage drop at 1 A, 2 to 4 V DC)
Actuator strength (static load)	112.7 N for 1 min
Terminal strength (static load)	24.5 N for 1 min
Ambient temperature	-25 to +70°C
Contact material	AgZnO alloy

Note: Compliant with JIS C 6571 (toggle switch for electronic devices).

DATA

Applicable to T-06 series only

Life curve

Tested condition: 125 V AC, 250 V AC
Power factor: 0.6 and 10 cpm

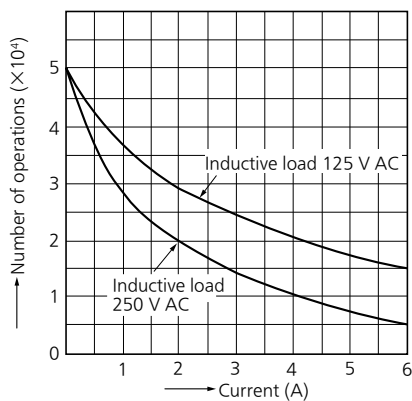

TERMINAL CIRCUIT DIAGRAM

T-06 and T-03 series common

			1-pole	2-pole
Terminal arrangement (As seen from terminal side)				
Actuator position and contact terminal number	ON-OFF	Keyway	2-3	2-3, 5-6
		—	—	—
		Keyway	—	—
	ON-ON	Keyway	2-3	2-3, 5-6
		—	—	—
		Keyway	1-2	1-2, 4-5
Remark			ON-OFF type does not have a terminal No. 1.	ON-OFF type does not have terminal No. 1 and 4.

DIMENSIONS

CAD The CAD data of the products with a "CAD" mark can be downloaded from our Website.

Unit: mm

T-06 and T-03 series common

CAD

External dimensions

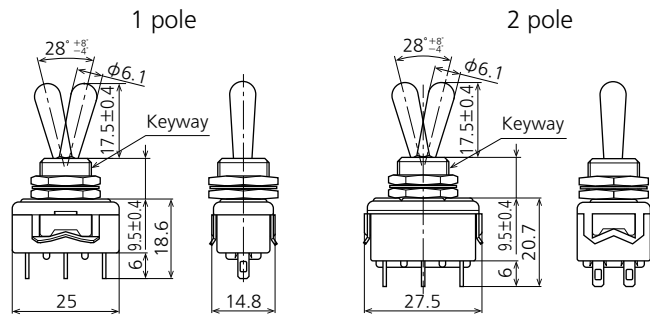

General tolerance: ±0.25

Note) ON-OFF type does not have terminal No. 1 and 4.

T-06/T-03 Series Switches (WD1)

MOUNTING DIMENSIONS

T-06 and T-03 series common

Applicable types	All types		
Panel cutout (Unit: mm)			
Panel thickness	Max. 2.5 mm* ¹ (Using separately sold keying washer.)* ²	Max. 3.5 mm* ¹	Max. 3.5 mm* ¹

Notes: 1. For panel installations, use the back hex nut.
2. Separately sold keying washer is Part No.: AJ3083

Accessories (Option)

Product name	Indication plate (aluminum)* ³		Rubber cap* ^{1, 2, 4}	
	ON-OFF	ON-ON	EP rubber type	Silicone rubber type
Dimensions (Unit: mm)				
Part No.	WD1901	WD1902	WD1911	WD1811*

Notes: 1. The asterisk "*" in the part number WD1811* for the silicon rubber type rubber cap is where the letter representing the color should be inserted. (B: black; R: red; Z: grey; Y: yellow; G: green.)
2. EP rubber cap is available in black only.
3. Letters on the display panel are aluminum colored and the area surrounding the letters is black.
4. Indication plate and rubber cap are compatible with the T-15 series switch, T-10 series switch, and T-03/T-06 series switches (when plate thickness is 2.7 mm or less).

Using the different rubber caps

We recommend silicon rubber and EP rubber caps for the following applications.

- 1) Silicon rubber type
 - When it is necessary to differentiate by color.
 - When using in applications that require resistance to heat and cold.
Ambient temperature: -25 to +85°C (EP rubber type is 0 to +40°C.)
 - When compactness is required.
- 2) EP rubber type
When cost is the primary consideration.

Please refer to **"the latest product specifications"** when designing your product.

•Requests to customers:

<https://industrial.panasonic.com/ac/e/salespolicies/>

TECHNICAL TERMINOLOGY

■ Rated values

Values indicating the characteristics and performance guarantee standards of the switches. The rated current and rated voltage, for instance, assume specific conditions.

■ Electrical life

The service life when the rated load is connected to the contact and switching operations are performed.

■ Mechanical life

The service life when operated at a preset operating frequency without passing electricity through the contacts.

■ Dielectric strength

Threshold limit value that a high voltage can be applied to a predetermined measuring location for one minute without causing damage to the insulation.

■ Insulation resistance

This is the resistance value at the same place the dielectric strength is measured.

■ Contact resistance

This indicates the electrical resistance at the contact part. Generally, this resistance includes the conductor resistance of the spring and terminal portions.

■ Vibration resistance

Vibration range where a closed contact does not open for longer than a specified time due to vibrations during use of the snapaction switches.

■ Shock resistance

Max. shock value where a closed contact does not open for longer than a specified time due to shocks during use of the switches.

■ Allowable switching frequency

This is the maximum switching frequency required to reach the end of mechanical life (or electrical life).

■ Temperature rise value

This is the maximum temperature rise value that heats the terminal portion when the rated current is flowing through the contacts.

■ Actuator strength

When applying a static load for a certain period on the actuator in the operation direction, this is the maximum load it can withstand before the switch loses functionality.

■ Terminal strength

When applying a static load for a certain period (in all directions if not stipulated) on a terminal, this is the maximum load it can withstand before the terminal loses functionality (except when the terminal is deformed).

TYPES OF LOAD

■ Resistance load

Resistance load is a power factor of 1 ($\cos\phi = 1$) where the load is only for the resistance portion. The displayed switch rating indicates the current capacity when using AC current.

■ DC load

Differing from AC, since the direction of current is fixed for DC, the continuous arc time lengthens when the same voltage is applied.

■ Incandescent lamp load

Since an inrush current of 10 to 15 times the rated current flows for an instant when the switch is turned on for the lamp, adhesion of the contacts may occur. Therefore, please take into consideration this transient current when selecting a switch.

■ Induction load

Since arc generation due to reverse voltage can cause contact failure to occur when there is an induction load (in relays, solenoids and buzzers, etc.), we recommend you insert a suitable spark quenching circuit (see figure below).

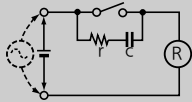
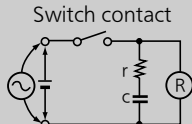
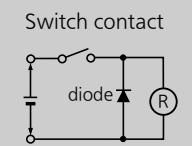
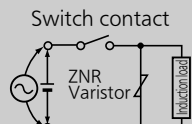
Circuit example	Notes
	(1) $r =$ more than $10\ \Omega$ (2) In an AC circuit, impedance of R is to be slightly smaller than impedance of r and c.
	Can be used for both AC and DC circuits. $r = R$ $C: 0.1\ \mu\text{F}$
	For DC circuits only.
	Can be used for both AC and DC circuits.

■ Motor load

Contacts may adhere due to the starting current at the start of motor operation which is three to eight times the steady-state current. Although it differs depending on the motor, since a current flows that is several times that of the nominal current, please select a switch taking into consideration the values in the table below. To make the motor rotate in reverse, use an ON-OFF-ON switch and take measures to prevent a multiplier current (starting current + reverse current) from flowing.

Motor type	Type	Starting current
Three-phase induction motor	Squirrel-cage	Approx. 5 to 8 times current listed on nameplate
Single-phase induction motor	Split-phase-start	Approx. 6 times current listed on nameplate
	Capacitor-start	Approx. 4 to 5 times current listed on nameplate
	Repulsion-start	Approx. 3 times current listed on nameplate

A current that is approximately two times that of the starting current will flow when reverse rotation is caused during operation. Also, when using for a load that will cause transient phenomena such as when operating the motor in reverse rotation or switching the poles, an arc short (circuit short) may occur due to the time lag between poles when switching. Please be careful.

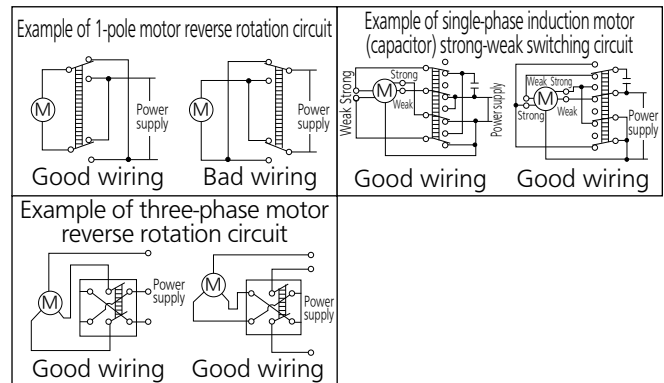

■ Capacitor load

In the case of mercury lamps, florescent lamps and the capacitor loads of capacitor circuits, since an extremely large inrush current flows when the switch is turned on, please measure that transient value with the actual load and then either use the product keeping within the range of the rated current or after verifying the actual load.

CAUTIONS FOR USE

Environment of use

- Please consult us when using under the following conditions:
 - Environments where hydrogen sulfide or other corrosive gases are present.
 - Environments where gasoline, thinner or other flammable, explosive gases are present.
 - Dusty environments (for non-seal type snap action switches).
 - Use in environments not in the prescribed temperature or humidity range.
 - Places with low air pressure.
- Unless specified the product will not be constructed to withstand water, oil or explosions. Please inquire if you intend to use the product in special applications.

Usage, storage, and transport conditions

- During usage, storage, or transportation, avoid locations subject to direct sunlight and maintain normal temperature, humidity, and pressure conditions.
- The allowable specifications for environments suitable for usage, storage, and transportation are given below.
 - Temperature: The allowable temperature range differs for each switch, so refer to the switch's individual specifications.
 - Humidity: 5 to 85% R.H.
 - Pressure: 86 to 106 kPa
The humidity range varies with the temperature. Use within the range indicated in the graph below.
(The allowable temperature depends on the switch.)

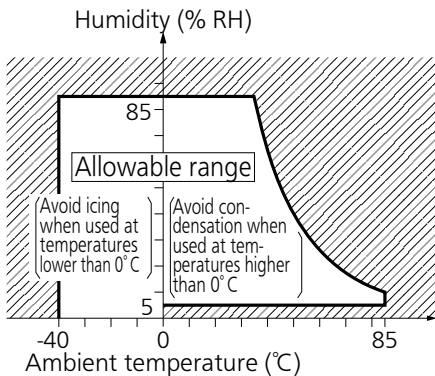

- Condensation will occur inside the switch if there is a sudden change in ambient temperature when used in an atmosphere of high temperature and high humidity. This is particularly likely to happen when being transported by ship, so please be careful of the atmosphere when shipping. Condensation is the phenomenon whereby steam condenses to cause water droplets that adhere to the switch when an atmosphere of high temperature and humidity rapidly changes from a high to low temperature or when the switch is quickly moved from a low humidity location to one of high temperature and humidity. Please be careful because condensation can cause adverse conditions such as deterioration of insulation, coil cutoff, and rust.
- Condensation or other moisture may freeze on the switch when the temperatures is lower than 0°C. This causes problems such as sticking of movable parts or operational time lags.
- The plastic becomes brittle if the switch is exposed to a low temperature, low humidity environment for long periods of time.
- Storage for extended periods of time (including transportation periods) at high temperatures or high humidity levels or in atmospheres with organic gases or sulfide gases may cause a sulfide film or oxide film to form on the surfaces of the contacts and/or it may interfere with the functions. Check out the atmosphere in which the units are to be stored and transported.
- In terms of the packing format used, make every effort to keep the effects of moisture, organic gases and sulfide gases to the absolute minimum.

Wiring

- When using a P/C board terminal switch as soldering terminals, use thin lead wires and be sure to wind them on the terminals before soldering.
- Caution when soldering
Perform soldering quickly in accordance with the specified conditions. Be careful not to let flux flow into the product. When no instruction is specified, use a soldering iron with a tip temperature of 350 C or lower and complete soldering within five seconds. Do not pull on the lead wires immediately after soldering. Wait some time before verifying.

Others

- Failure modes of switches include short-circuiting, opencircuiting and temperature rises. If this switch is to be used in equipment where safety is a prime consideration, examine the possible effects of these failures on the equipment concerned, and ensure safety by providing protection circuits or protection devices. In terms of the systems involved, make provision for redundancy in the design and take steps to achieve safety design.
- The ambient operating temperature (and humidity) range quoted is the range in which the switch can be operated on a continuous basis: it does not mean that using the switch within the rating guarantees the durability performance and environment withstanding performance of the switch. For details on the performance guarantee, check the specifications of each product concerned.
- Even if 2-pole, 3-pole or 4-pole switches are used as singlepole switches in order to increase contact reliability, please keep the maximum current no higher than the rated value.
- If there is the possibility of a short between poles, please use an in-phase circuit as shown below or provide a spare pole.

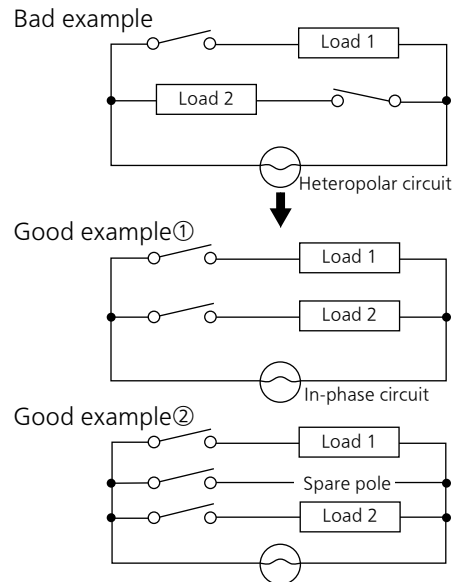

- Be careful not to drop the product as this may cause loss of functionality.
- Do not apply an unreasonable vertical force against the direction of operation of the product.
- Use your hand to operate the actuator.
(Operation using a tool such as a screwdriver or hammer can cause breakdown.)

Please contact

Panasonic Corporation

Electromechanical Control Business Division

■1006, Oaza Kadoma, Kadoma-shi, Osaka 571-8506, Japan
industrial.panasonic.com/ac/e/

Panasonic[®]

©Panasonic Corporation 2021