

LTC3605A

20V, 5A Monolithic Synchronous Step-Down Regulator

DESCRIPTION

Demonstration circuit 1897 is a step-down converter, using the [LTC[®]3605A](#) monolithic synchronous buck regulator. The DC1897B has a maximum input voltage of 20V, and is capable of delivering up to 5A of output current at a minimum input voltage of 4V. The output voltage of the DC1897B can be set as low as 0.6V, the reference voltage of the LTC3605A. At low load currents, the DC1897B operates in discontinuous mode, and during shutdown, it consumes 11 μ A of quiescent current typically. The DC1897B can achieve efficiency over 90%. The LTC3605A has phase-lock-loop circuits, allowing high current multiphase operation of several DC1897Bs in parallel. The

DC1897B can also track another voltage with the LTC3605A track function. Because of the high switching frequency of the LTC3605A, which is programmable up to 4MHz, the DC1897B uses low profile surface mount components. All these features make the DC1897B an ideal circuit for use in industrial applications and distributed power systems

Design files for this circuit board are available at <http://www.linear.com/demo>

LT, LT, LTC, LTM, Linear Technology and the Linear logo are registered trademarks of Linear Technology Corporation. All other trademarks are the property of their respective owners.

PERFORMANCE SUMMARY

Table 1. Performance Summary

| PARAMETER | CONDITIONS | VALUE |
|-------------------------------|--|--|
| Input Voltage Range | | 4V to 20V |
| Output Voltage Range | | 0.6V to 5V |
| Run/Shutdown | | GND = Shutdown V_{IN} = Run |
| Output Voltage Regulation | V_{IN} = 4V to 20V, I_{OUT} = 0A to 5A V_{IN} = 4.7V to 20V, I_{OUT} = 0A to 5A V_{IN} = 6.4V to 20V, I_{OUT} = 0A to 5A | 2.5V \pm 2% Typical (2.45V to 2.55V) 3.3V \pm 2% Typical (3.234V to 3.366V) 5V \pm 2% Typical (4.9V to 5.1V) |
| Typical Output Ripple Voltage | V_{IN} = 12V, V_{OUT} = 2.5V I_{OUT} = 5A (20MHz BW) | <20mV _{P-P} |
| Discontinuous Mode | V_{IN} = 12V, V_{OUT} = 2.5V V_{IN} = 12V, V_{OUT} = 3.3V V_{IN} = 12V, V_{OUT} = 5V | I_{OUT} < 1.25A I_{OUT} < 1.45A I_{OUT} < 1.65A |
| Phase | Phase = INTV _{CC} Phase = GND Phase = Floating | 180° Out-of-Phase: 2 Phase 120° Out-of-Phase: 3 Phase 90° Out-of-Phase: 4 Phase |
| Nominal Switching Frequency | R_T = 162k | 1MHz \pm 20% |

Table 2. Jumper Description

| JUMPER | FUNCTION | RANGE/SETTING (DEFAULT) |
|--------|---|-------------------------------|
| JP1 | Output Voltage Setting | 2.5V |
| JP5 | Phase Mode (PHMODE): 180 Degrees Out-of-Phase (DOP) – 2 Phase, 120 DOP – 3 Phase, or 90 DOP – 4 Phase | (2 PHASE) – 3 PHASE – 4 PHASE |
| JP6 | Mode: Forced Continuous Mode (FCM) or Discontinuous Mode (DCM) | (FCM) – DCM |
| JP7 | Run | (ON) – OFF |

dc1897bf

QUICK START PROCEDURE

Demonstration Circuit 1897 is easy to set up to evaluate the performance of the LTC3605A. For proper measurement equipment configuration, set up the circuit according to the diagram in Figure 1. Before proceeding to test, check that the shunts are inserted into these positions: the 2.5V output voltage header JP1, the 180° out-of-phase (2-PHASE) position of the phase mode (PHMODE) header JP5, the forced continuous mode (FCM) position of mode header JP6, and the on position of run header JP7.

When measuring the input or output voltage ripple, care must be taken to avoid a long ground lead on the oscilloscope probe. Measure the input or output voltage ripple by touching the probe tip directly across the VIN or VOUT and GND terminals. See Figure 2 for proper scope probe measurement technique.

With the DC1897B set up according to the proper measurement configuration and equipment in Figure 1, apply 6.3V at VIN (do not increase VIN over the rated maximum supply voltage of 20V, or the part may be damaged). Measure VOUT; it should read 2.5V (If desired, the quiescent current of the circuit can be monitored now by swapping the shunt in header JP7 into the OFF position). The output voltage should be regulating. Measure VOUT—it should measure 2.5V ±2% (2.45V to 2.55V).

Vary the input voltage from 4V to 20V and adjust the load current from 0 to 5A. VOUT should regulate around 2.5V ±3% (2.425V to 2.575V). Measure the output ripple voltage—it should measure less than 30mV AC.

Observe the voltage waveform at the switch pins (the other side of the inductor from the output). Verify the switching frequency is between 800kHz and 1.2MHz ($t = 1.25\text{ns}$ and 833ns), and that the switch node waveform is rectangular in shape.

Change the shunt position on the MODE header from FCM to DCM (discontinuous mode). Set the input voltage to 12V and the output current to any current less than 1A. Observe the discontinuous mode of operation at the switch node, and measure the output ripple voltage. It should measure less than 100mV AC.

Insert the JP7 shunt into the OFF position and move the shunt in the 2.5V output JP1 header into any of the two remaining output voltage option headers: 3.3V (JP2) or 5V (JP3). Just as in the 2.5V VOUT test, the output voltage should read VOUT ±1% tolerance under static line and load conditions and ±1% tolerance under dynamic line and load conditions (±2% total). Also, the circuit operation in discontinuous mode will be the same. When finished, turn off the circuit by inserting the shunt in header JP7 into the OFF position.

QUICK START PROCEDURE

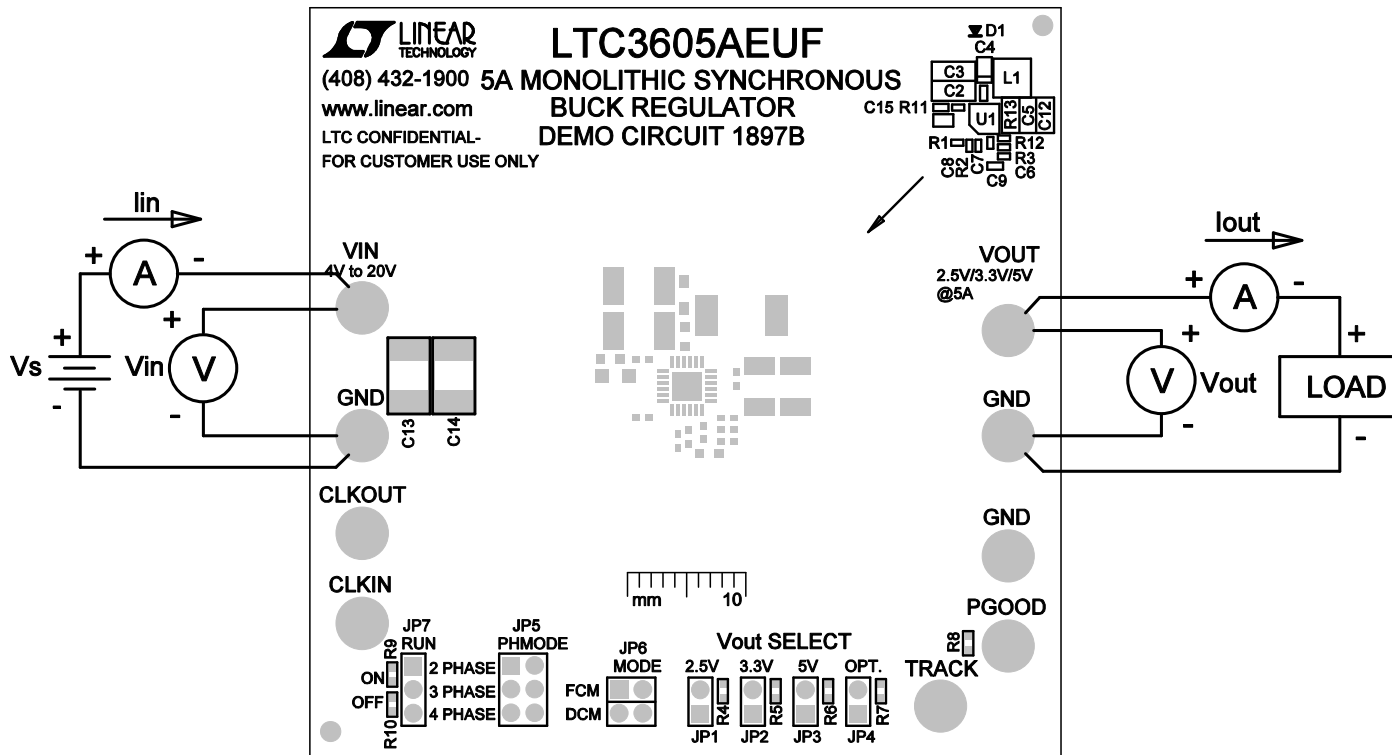

Figure 1. Proper Equipment Measurement Setup

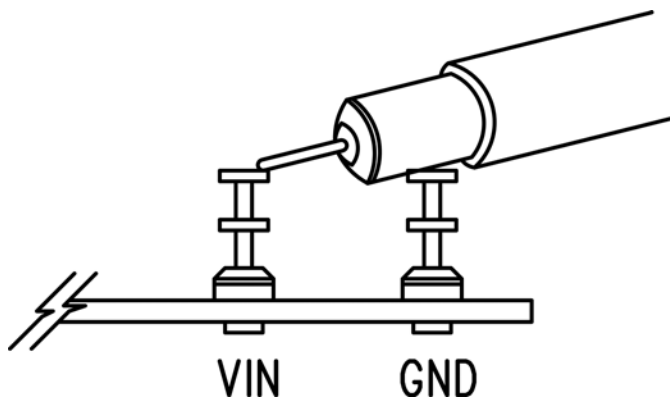

Figure 2. Measuring Input or Output Ripple

QUICK START PROCEDURE

Normal Switching Frequency and Output Ripple Voltage Waveforms



$V_{IN} = 12V$, $V_{OUT} = 5V$, $I_{OUT} = 5A$, $f_{SW} = 1MHz$
 Trace 1: Switch Voltage (5V/Div)
 Trace 2: Output Ripple Voltage (20mV/Div AC)

Figure 3. Switch Node and Output Ripple Voltage Waveforms

Load Step Response Waveforms

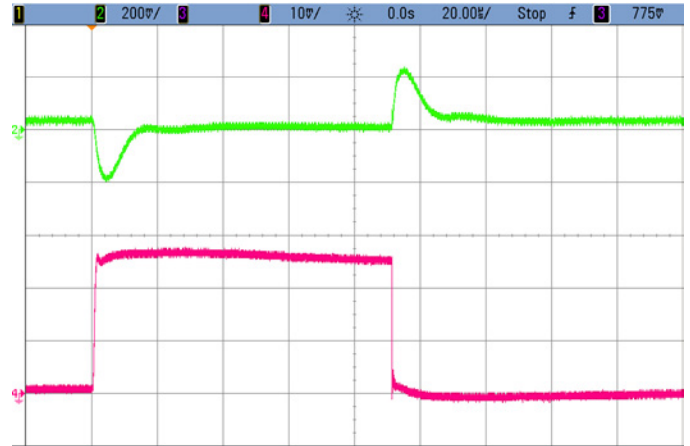

$V_{IN} = 12V$, $V_{OUT} = 5V$, 5A Load Step (0A to 5A)
 Forced Continuous Mode, $f_{SW} = 1MHz$
 Trace 2: Output Voltage (200mV/Div AC)
 Trace 4: Output Current (2A/Div)

Figure 4. Load Step Response

Load Step Response Waveforms

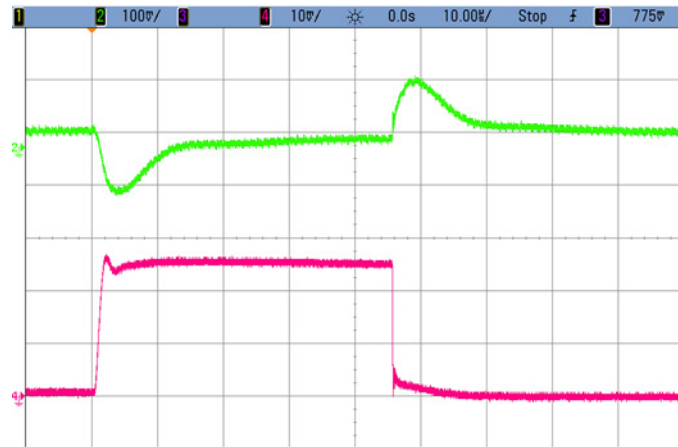

$V_{IN} = 12V$, $V_{OUT} = 2.5V$, 5A Load Step (0A to 5A)
 Forced Continuous Mode, $f_{SW} = 1MHz$
 Trace 2: Output Voltage (100mV/Div AC)
 Trace 4: Output Current (2A/Div)

Figure 5. Load Step Response

Load Step Response Waveforms

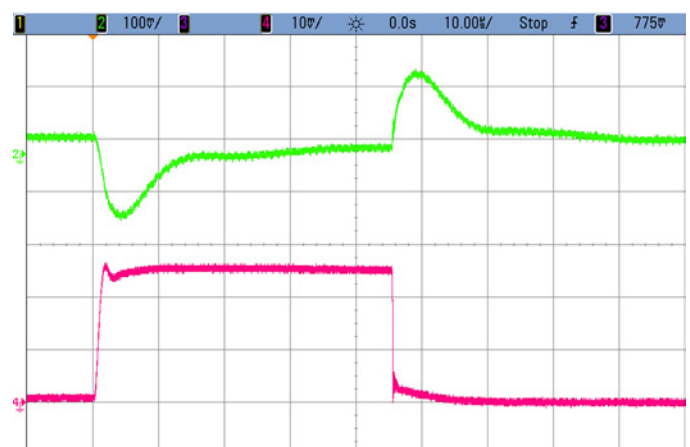

$V_{IN} = 12V$, $V_{OUT} = 3.3V$, 5A Load Step (0A to 5A)
 Forced Continuous Mode, $f_{SW} = 1MHz$
 Trace 2: Output Voltage (100mV/Div AC)
 Trace 4: Output Current (2A/Div)

Figure 6. Load Step Response

QUICK START PROCEDURE

2-Phase Dual Output Waveforms

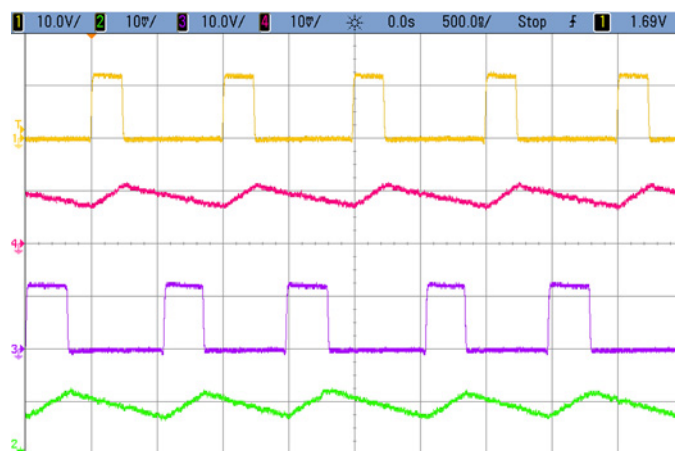

$V_{IN} = 12V$, $V_{OUT1} = 2.5V$, $I_{OUT1} = 5A$, $V_{OUT2} = 3.3V$, $I_{OUT2} = 5A$,
 $f_{SW} = 1MHz$

Trace 1: V_{OUT1} Switch Voltage (10V/Div)

Trace 4: L1 Ripple Current (5A/Div)

Trace 3: V_{OUT2} Switch Voltage (10V/Div)

Trace 2: L2 Ripple Current (5A/Div)

Figure 7. Switch Node Voltage and Inductor Ripple Current Waveforms of Two Circuits Operating 180° Out-of-Phase

Circuit Efficiency

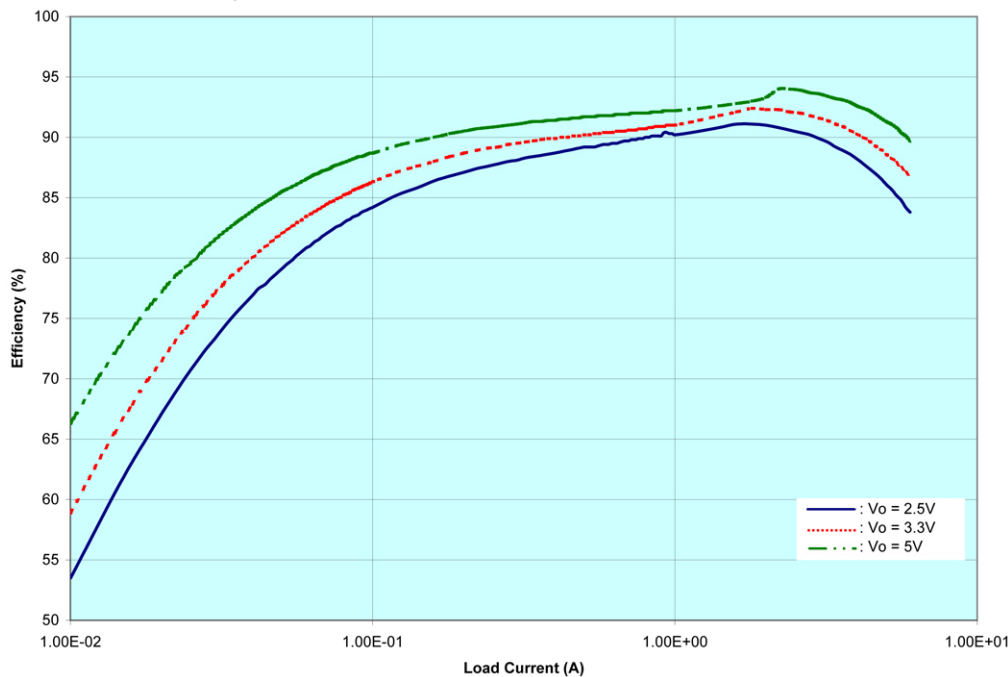

$V_{IN} = 12V$
 Discontinuous Mode, $f_{SW} = 1MHz$

Figure 8. Efficiency Graph

DEMO MANUAL DC1897B

PARTS LIST

| ITEM | QTY | REFERENCE | PART DESCRIPTION | MANUFACTURER/PART NUMBER |
|---|-----|--------------------|---|----------------------------------|
| Required Circuit Components | | | | |
| 1 | 1 | C1 | CAP, 0805 2.2 μ F 20% 10V X5R | AVX 0805ZD225MAT2A |
| 2 | 2 | C2, C3 | CAP, 1210 22 μ F 20% 25V X7R | MURATA GRM32ER61E226ME15L |
| 3 | 1 | C4 | CAP, 0603 0.1 μ F 20% 25V X7R | AVX 06033C104MAT2A |
| 4 | 2 | C5, C12 | CAP, 1206 47 μ F 20% 10V X5R | TAIYO YUDEN LMK316BJ476ML-T |
| 5 | 1 | C6 | CAP, 0402 220pF 20% 50V COG | AVX 04025A221MAT2A |
| 6 | 1 | C7 | CAP, 0402 10pF 20% 50V COG | AVX 04025A100MAT2A |
| 7 | 1 | C8 | CAP, 0402 100pF 20% 50V COG | AVX 04025A101MAT2A |
| 8 | 1 | D1 | DIODE, CMDSH-3, SOD-323 | CENTRAL SEMI. CMDSH-3TR |
| 9 | 1 | L1 | IND 1.0 μ H | VISHAY IHLP2525CZER1R0M01 |
| 10 | 1 | R1 | RES, 0402 162k 1% 1/16W | VISHAY, CRCW0402162KFKED |
| 11 | 1 | R2 | RES, 0402 10k 1% 1/16W | VISHAY CRCW040210K0FKED |
| 12 | 1 | R3 | RES, 0402 14k 1% 1/16W | VISHAY CRCW040214K0FKED |
| 13 | 1 | R4 | RES, 0402 3.16k 1% 1/16W | VISHAY CRCW04023K16FKED |
| 14 | 1 | R13 | RES, 0402 0 Ω JUMPER | VISHAY CRCW04020000Z0ED |
| 15 | 1 | U1 | IC, QFN24 | LINEAR TECHNOLOGY, LTC3605AEUF |
| Additional Demo Board Circuit Components | | | | |
| 1 | 2 | C9, C15 | CAP, 0603 0.1 μ F 20% 25V X7R | AVX 06033C104MAT2A |
| 2 | 1 | C10 | CAP, 7343 22 μ F 20% 35V TANT | AVX TPSY226M035R |
| 3 | 0 | C11 | CAP, 1206 OPTION | OPTION |
| 4 | 0 | C13, C14 | CAP, 1812 22 μ F 20% 25V X7R OPTION | TDK C4532X7R1E226M OPTION |
| 5 | 1 | R5 | RES, 0402 2.21k 1% 1/16W | VISHAY CRCW04022K21FKED |
| 6 | 1 | R6 | RES, 0402 1.37k 1% 1/16W | VISHAY CRCW04021K37FKED |
| 7 | 0 | R7, R12 | RES, 0402 OPTION | OPTION |
| 8 | 4 | R8, R10, R14, R15 | RES, 0402 100k 5% 1/16W | VISHAY CRCW0402100KJNED |
| 9 | 1 | R9 | RES, 0402 150k 5% 1/16W | VISHAY CRCW0402150KJNED |
| 11 | 1 | R11 | RES, 0402 10 Ω 5% 1/16W | VISHAY CRCW040210R0JNED |
| Hardware—For Demo Board Only | | | | |
| 1 | 9 | E1-E9 | TURRET | MIIL-MAX 2501-2-00-80-00-00-07-0 |
| 2 | 4 | JP1, JP2, JP3, JP4 | HEADER, SINGLE ROW, 2-PIN, 2mm | SULLINS, NRPN021PAEN-RC |
| 3 | 1 | JP5 | HEADER, 3-PIN, DBL ROW 2mm | SULLINS, NRPN03PAEN-RC |
| 4 | 1 | JP6 | HEADER, 2mm DBL ROW (2X2) 4-PIN | SULLINS, NRPN022PAEN-RC |
| 5 | 1 | JP7 | HEADER, 2mm, 3-PIN | SULLINS, NRPN031PAEN-RC |
| 6 | 4 | JP1, JP5-JP7 | SHUNT, 2mm | SAMTEC 2SN-BK-G |

DEMO MANUAL DC1897B

DEMONSTRATION BOARD IMPORTANT NOTICE

Linear Technology Corporation (LTC) provides the enclosed product(s) under the following **AS IS** conditions:

This demonstration board (DEMO BOARD) kit being sold or provided by Linear Technology is intended for use for **ENGINEERING DEVELOPMENT OR EVALUATION PURPOSES ONLY** and is not provided by LTC for commercial use. As such, the DEMO BOARD herein may not be complete in terms of required design-, marketing-, and/or manufacturing-related protective considerations, including but not limited to product safety measures typically found in finished commercial goods. As a prototype, this product does not fall within the scope of the European Union directive on electromagnetic compatibility and therefore may or may not meet the technical requirements of the directive, or other regulations.

If this evaluation kit does not meet the specifications recited in the DEMO BOARD manual the kit may be returned within 30 days from the date of delivery for a full refund. **THE FOREGOING WARRANTY IS THE EXCLUSIVE WARRANTY MADE BY THE SELLER TO BUYER AND IS IN LIEU OF ALL OTHER WARRANTIES, EXPRESSED, IMPLIED, OR STATUTORY, INCLUDING ANY WARRANTY OF MERCHANTABILITY OR FITNESS FOR ANY PARTICULAR PURPOSE. EXCEPT TO THE EXTENT OF THIS INDEMNITY, NEITHER PARTY SHALL BE LIABLE TO THE OTHER FOR ANY INDIRECT, SPECIAL, INCIDENTAL, OR CONSEQUENTIAL DAMAGES.**

The user assumes all responsibility and liability for proper and safe handling of the goods. Further, the user releases LTC from all claims arising from the handling or use of the goods. Due to the open construction of the product, it is the user's responsibility to take any and all appropriate precautions with regard to electrostatic discharge. Also be aware that the products herein may not be regulatory compliant or agency certified (FCC, UL, CE, etc.).

No License is granted under any patent right or other intellectual property whatsoever. **LTC assumes no liability for applications assistance, customer product design, software performance, or infringement of patents or any other intellectual property rights of any kind.**

LTC currently services a variety of customers for products around the world, and therefore this transaction **is not exclusive**.

Please read the DEMO BOARD manual prior to handling the product. Persons handling this product must have electronics training and observe good laboratory practice standards. **Common sense is encouraged.**

This notice contains important safety information about temperatures and voltages. For further safety concerns, please contact a LTC application engineer.

Mailing Address:

Linear Technology
1630 McCarthy Blvd.
Milpitas, CA 95035

Copyright © 2004, Linear Technology Corporation

dc1897bf

8

Linear Technology Corporation
1630 McCarthy Blvd., Milpitas, CA 95035-7417
(408) 432-1900 • FAX: (408) 434-0507 • www.linear.com

LT 1213 • PRINTED IN USA



© LINEAR TECHNOLOGY CORPORATION 2013