



TDK's New Winding Type Chip Inductor

GLF, GLC Series



Item Line-Up



Height[mm]		0.80mm	1.25mm	1.80mm
Area[mm ²]				
1.28mm ²	1.60X0.80	GLF1608Type L:1uH to 22uH Rdc:0.70ohm(10uH) Idc:90mA(10uH)	GLF_Type:Low Rdc Type GLF_Type:Low Profile Type GLC_Type:High Idc Type	
2.50mm ²	2.00X1.25	GLF201208Type L:1uH to 47uH Rdc:1.10ohm(10uH) Idc:170mA(10uH)	GLF2012Type L:1uH to 100uH Rdc:0.36ohm(10uH) Idc:140mA(10uH)	
4.50mm ²	2.50X1.80		GLF251812Type L:1uH to 100uH Rdc:0.60ohm(10uH) Idc:325mA(10uH)	GLF2518Type L:1uH to 100uH Rdc:0.20ohm(10uH) Idc:210mA(10uH) GLC2518Type L:1uH to 100uH Rdc:0.30ohm(10uH) Idc:300mA(10uH)



Shapes and Dimensions

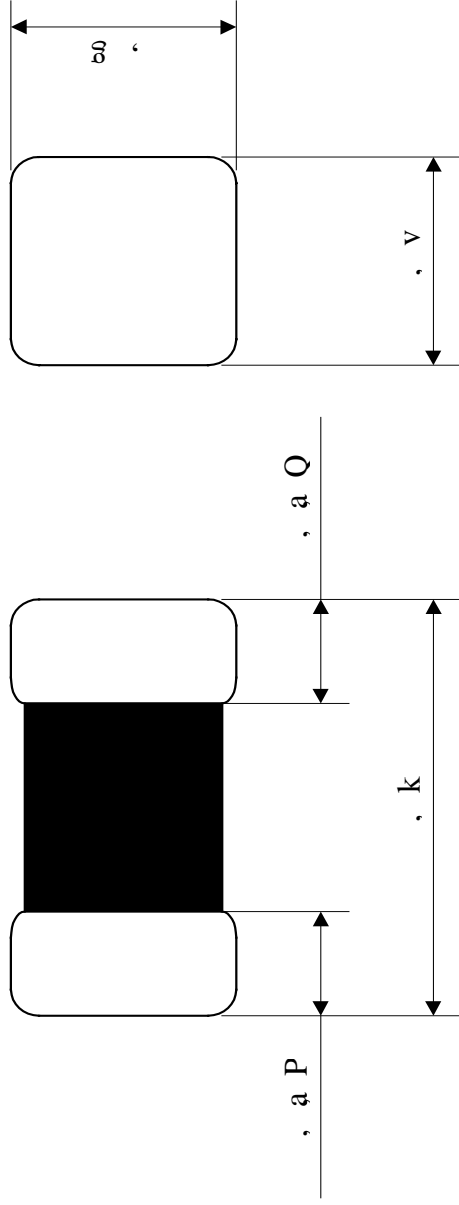

	L [mm] ±0.10	W [mm] ±0.10	H [mm] ±0.10	B1 [mm] ±0.15	B2 [mm] ±0.15	Weight [mg]
GLF1608Type	1.60	0.80	0.80	0.40	0.40	5mg
GLF2012Type	2.00	1.25	1.25	0.50	0.50	15mg
GLF2518Type	2.50	1.80	1.80	0.60	0.60	35mg
GLF201208Type	2.00	1.25	0.80	0.45	0.45	10mg
GLF251812Type	2.50	1.80	1.25	0.50	0.50	25mg
GLC2518Type	2.50	1.80	1.80	0.60	0.60	35mg



Electrical Characteristics [GLF1608Type]



ITEM	Inductance & Tolerance	Rdc[ohm]	Idc[mA]		
			L:10%Down Max.	L:20%Down Max.	temp. has to 20Deg.C Max.
GLF1608T1R0M	1.0μH±20%	±30% 0.17	125	220	400
GLF1608T2R2M	2.2μH±20%	0.33	85	160	275
GLF1608T4R7M	4.7μH±20%	0.55	70	115	220
GLF1608T100M	10μH±20%	0.70	50	90	180
GLF1608T220M	22μH±20%	3.00	35	60	100



Electrical Characteristics [GLF2012Type]



ITEM	Inductance & Tolerance	Rdc[ohm]	Idc[mA]		
			L:10%Down Max.	L:20%Down Max.	temp. has to 20Deg.C Max.
GLF2012T1R0M	1.0μH±20%	0.07 ±30%	275	400	850
GLF2012T2R2M	2.2μH±20%	0.10	210	300	700
GLF2012T4R7M	4.7μH±20%	0.24	120	200	450
GLF2012T100K	10μH±10%	0.36	100	140	360
GLF2012T220K	22μH±10%	1.00	75	100	220
GLF2012T470K	47μH±10%	1.70	50	75	170
GLF2012T101K	100μH±10%	4.00	30	50	110



Electrical Characteristics [GLF2518Type]



ITEM	Inductance & Tolerance	Rdc[ohm]	Idc[mA]		
			L:10%Down Max.	L:20%Down Max.	temp. has to 20Deg.C Max.
GLF2518T1R0M	1.0μH±20%	0.05±30%	500	675	1200
GLF2518T2R2M	2.2μH±20%	0.08±30%	340	450	950
GLF2518T4R7M	4.7μH±20%	0.11±30%	240	320	800
GLF2518T100K	10μH±10%	0.20±20%	165	210	600
GLF2518T220K	22μH±10%	0.45±20%	115	150	400
GLF2518T470K	47μH±10%	0.85±20%	85	100	275
GLF2518T101K	100μH±10%	1.90±20%	55	75	175



Electrical Characteristics [GLF201208Type]



ITEM	Inductance & Tolerance	Rdc[ohm]	Idc[mA]		
			L:10%Down Max.	L:20%Down Max.	temp. has to 20Deg.C Max.
GLF201208T1R0M	1.0μH±20%	0.19±20%	340	460	650
GLF201208T2R2M	2.2μH±20%	0.56±20%	220	300	350
GLF201208T4R7M	4.7μH±20%	0.74±20%	160	230	300
GLF201208T100M	10μH±20%	1.10±20%	130	170	250
GLF201208T220M	22μH±20%	3.50±20%	80	110	150
GLF201208T470M	47μH±20%	5.30±20%	60	90	120



Electrical Characteristics [GLF251812Type]



ITEM	Inductance & Tolerance	Rdc[ohm]	Idc[mA]		
			L:10%Down Max.	L:20%Down Max.	temp. has to 20Deg.C Max.
GLF251812T1R0M	1.0μH±20%	0.10±20%	650	800	900
GLF251812T2R2M	2.2μH±20%	0.20±20%	450	600	625
GLF251812T4R7M	4.7μH±20%	0.38±20%	275	450	450
GLF251812T100M	10μH±20%	0.60±20%	200	325	350
GLF251812T220M	22μH±20%	1.20±20%	140	250	250
GLF251812T470M	47μH±20%	2.50±20%	100	175	175
GLF251812T101M	100μH±20%	4.70±20%	80	125	125



Electrical Characteristics [GLC2518Type]



ITEM	Inductance & Tolerance	Rdc[ohm]	Idc[mA]		
			L:10%Down Max.	L:20%Down Max.	temp. has to 20Deg.C Max.
GLC2518T1R0M	1.0μH±20%	0.08±30%	850	-----	980
GLC2518T2R2M	2.2μH±20%	0.13±30%	650	-----	750
GLC2518T4R7M	4.7μH±20%	0.20±30%	475	-----	600
GLC2518T100K	10μH±10%	0.36±20%	350	-----	470
GLC2518T220K	22μH±10%	0.90±20%	225	-----	300
GLC2518T470K	47μH±10%	1.90±20%	170	-----	200
GLC2518T101K	100μH±10%	3.50±20%	110	-----	150



Typical Electrical Characteristics [GLF1608Type]

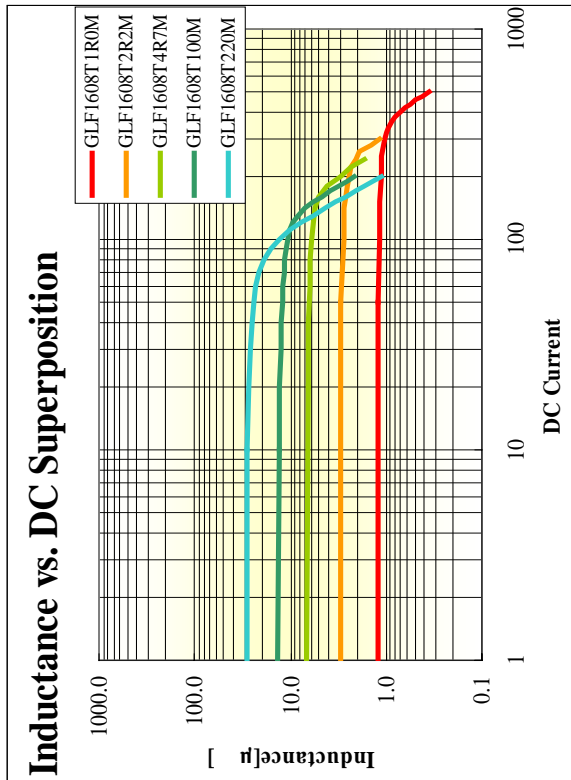
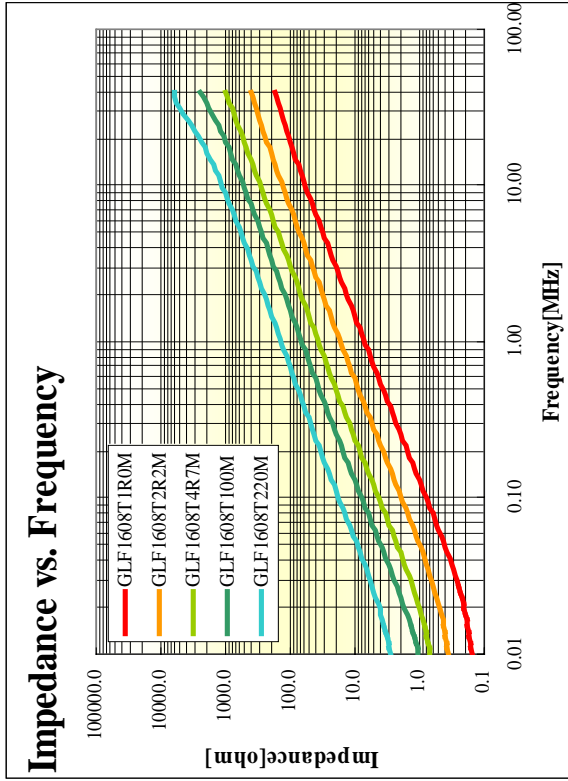
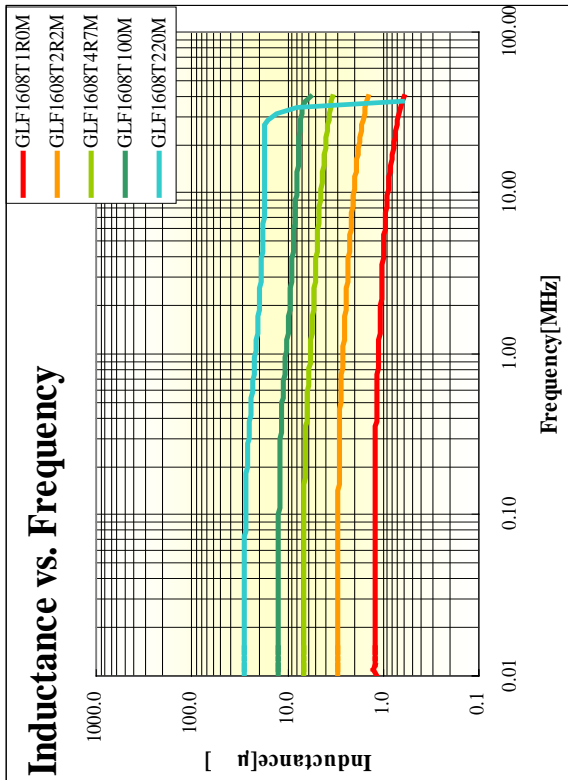



Typical Electrical Characteristics [GLF2012Type]

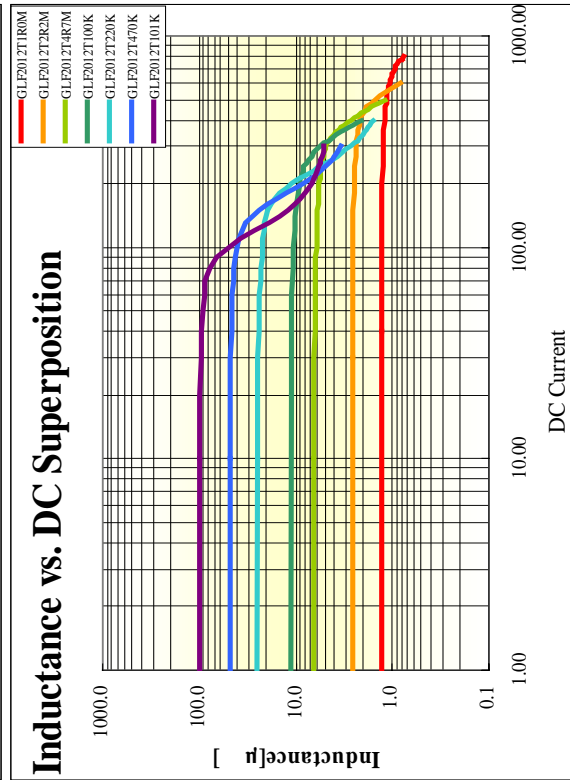
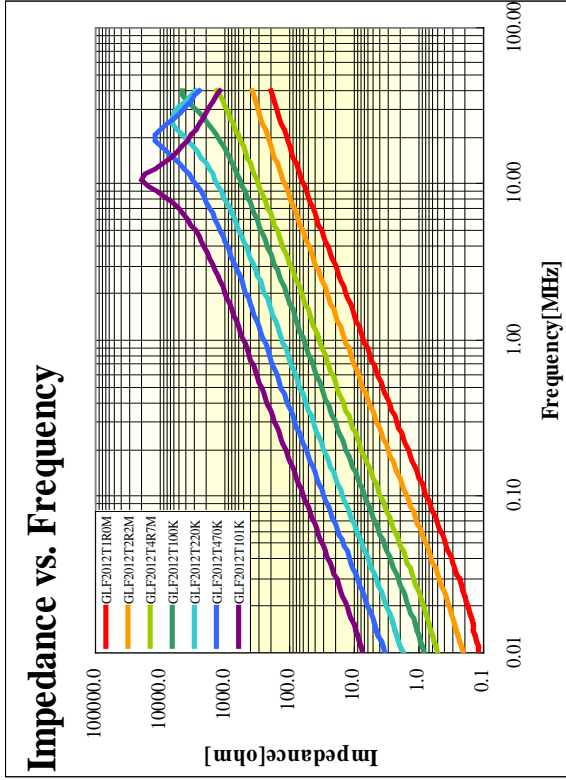
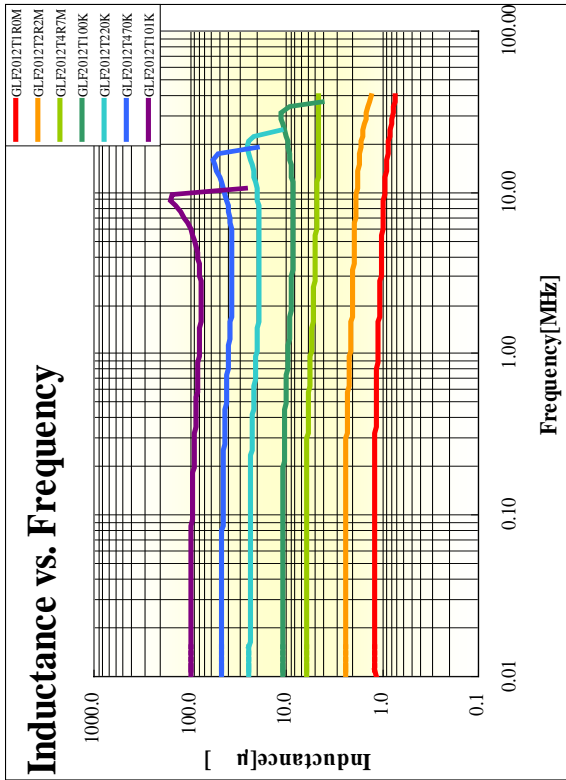



Typical Electrical Characteristics [GLF2518Type]

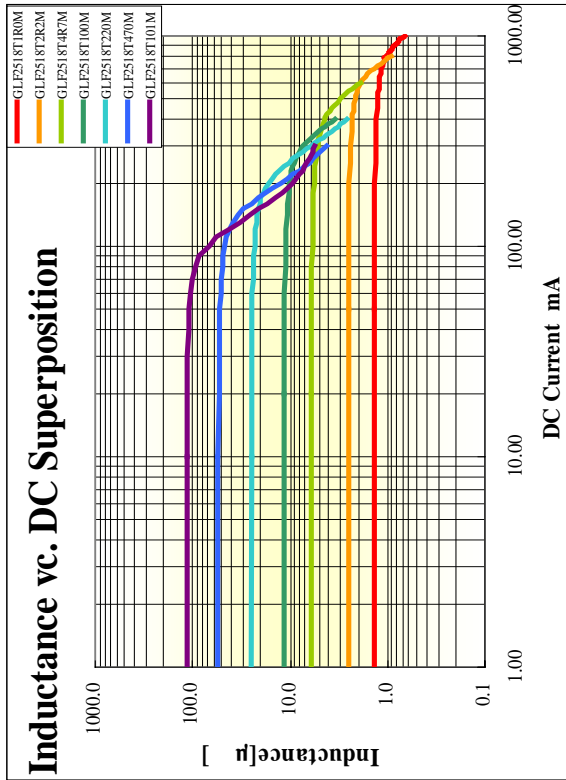
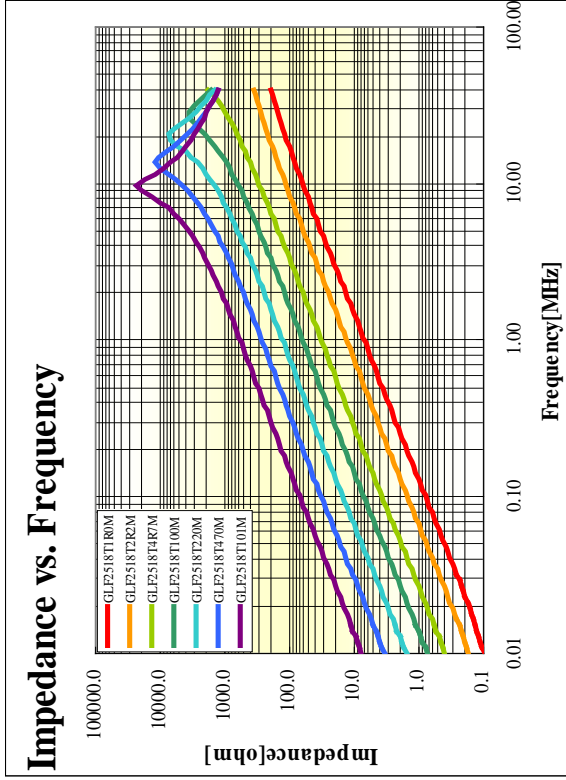
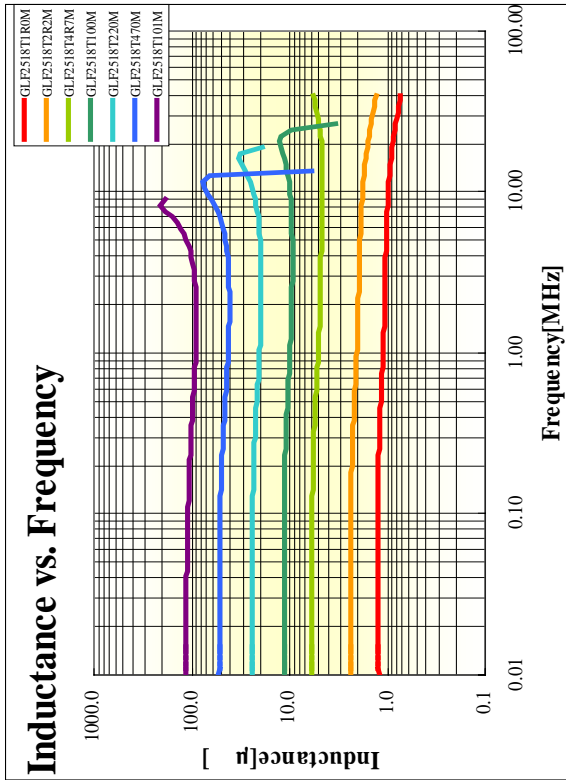



Typical Electrical Characteristics [GLF201208Type]

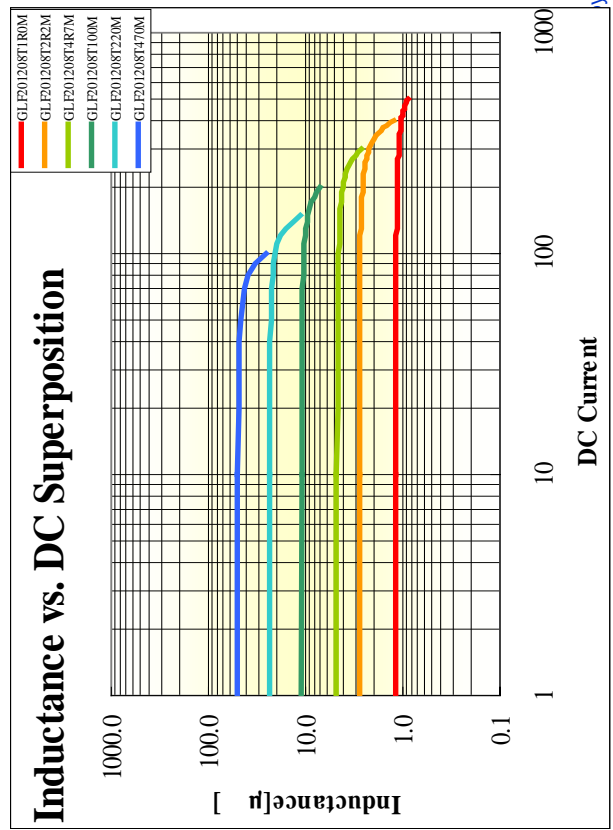
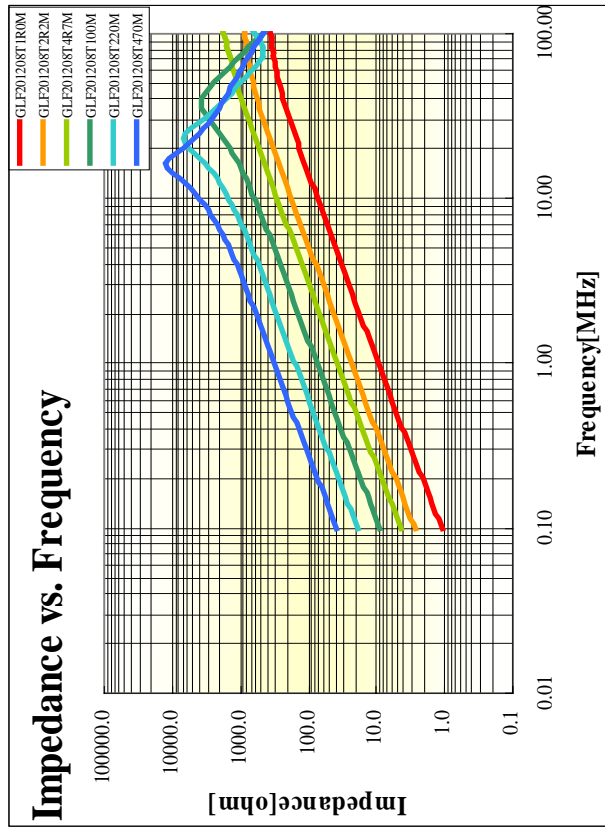
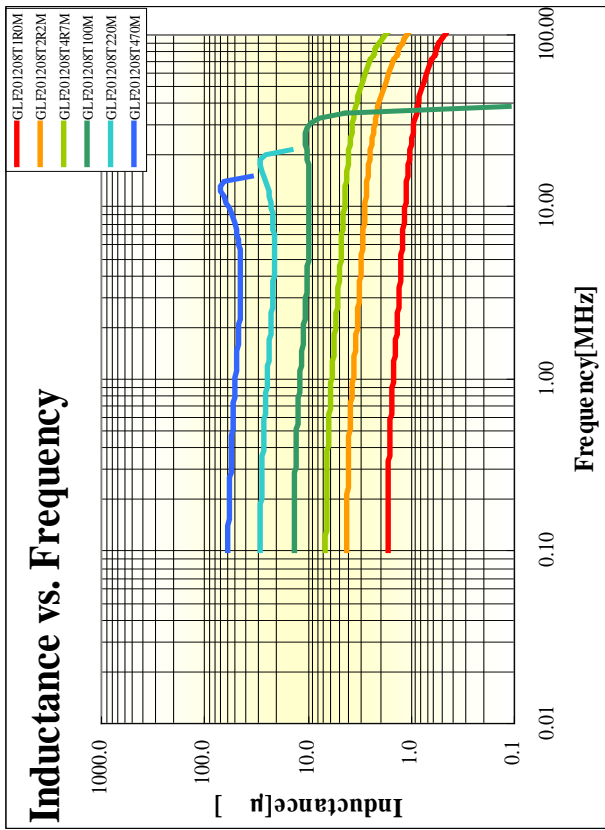



Typical Electrical Characteristics [GLF251812Type]

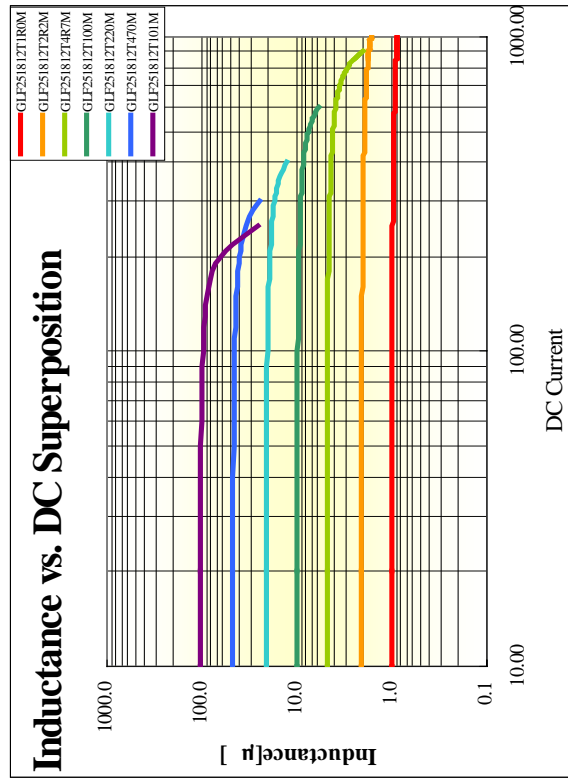
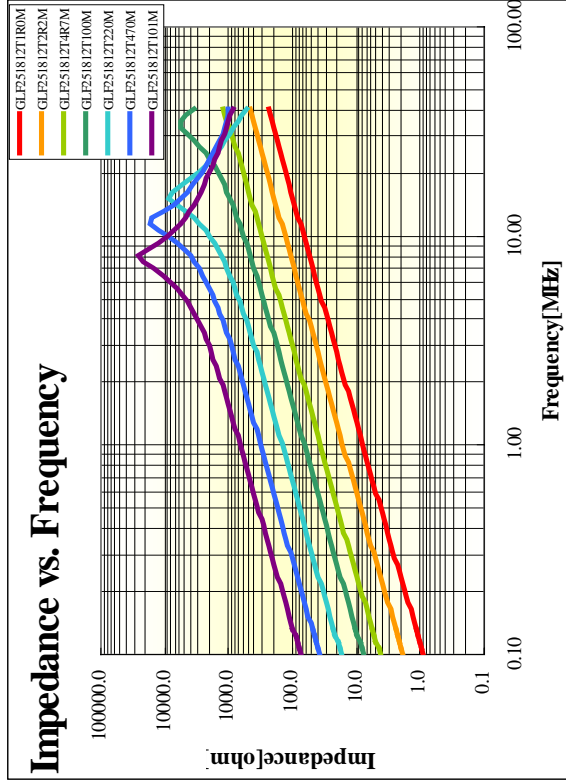
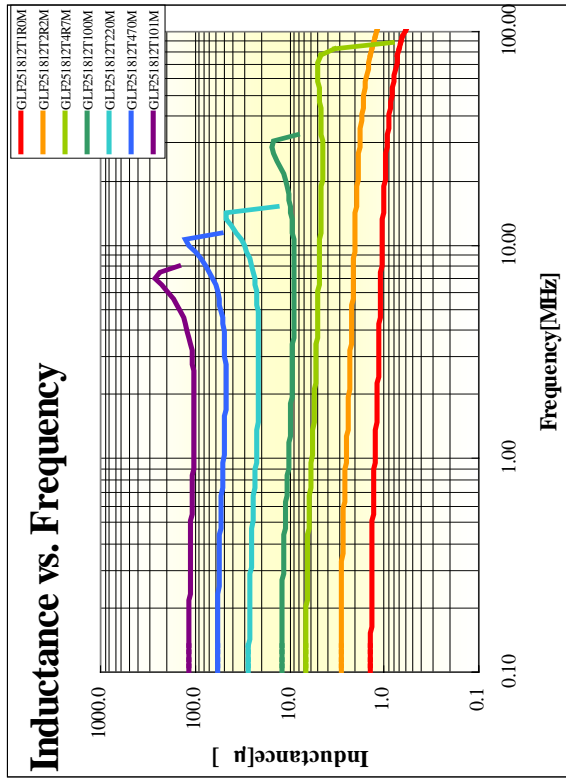

Typical Electrical Characteristics [GLC2518Type]

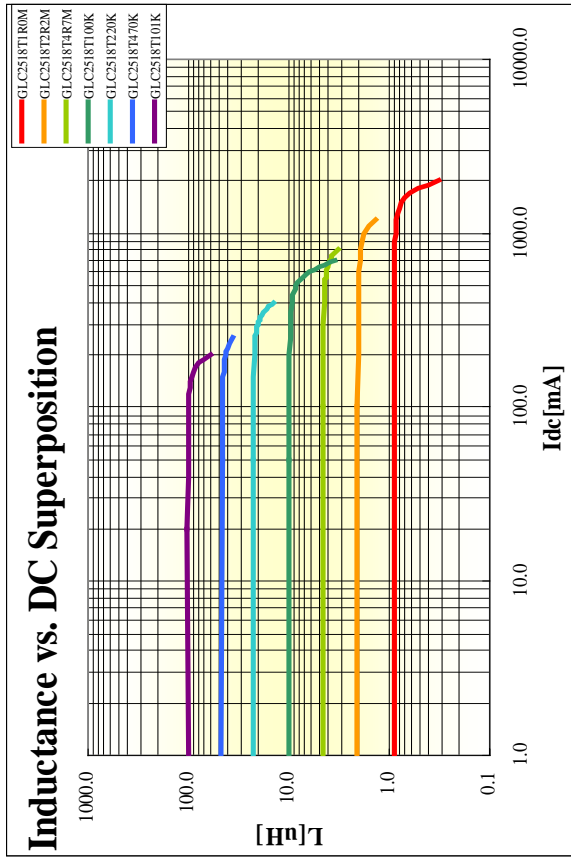
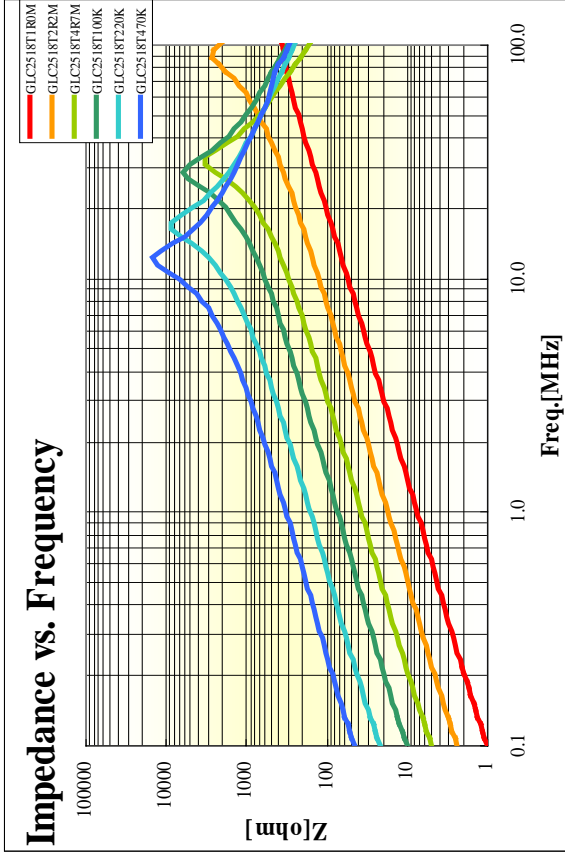
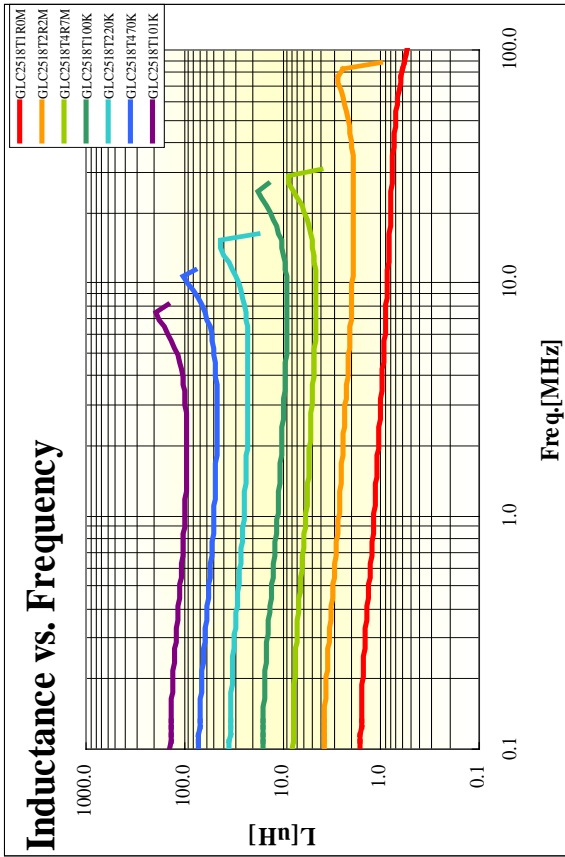



GLF & GLC Series Basic Information



Ratings

Temperature rise: 20C° max.

Storage temperature range: -40C° to 105C°

Operating temperature range: -20C° to 105C°

Country of origin

Japan

(TDK Shonai Manufacturing Corporation/Yamagata)



The Recommended Land Pattern

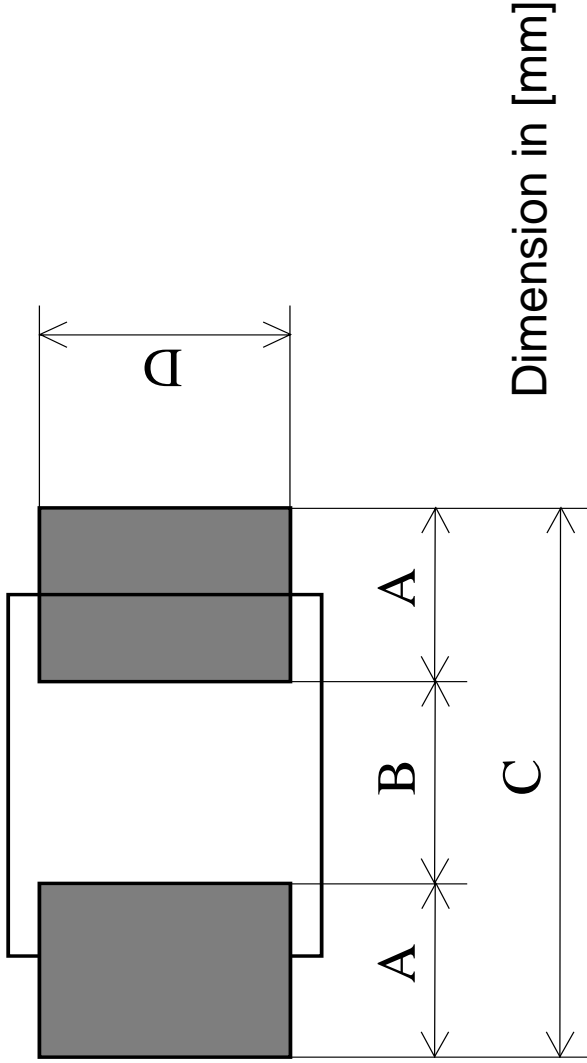

Dimension in [mm]

	A [mm]	B [mm]	C [mm]	D [mm]
GLF1608Type	0.70	0.70	2.10	0.70
GLF2012Type	0.80	1.00	2.60	0.80
GLF201208Type				
GLF2518Type				
GLF251812Type	0.90	1.30	3.10	1.60
GLC2518Type				



Reliability requirements



Test Item	Test Condition	Specification	TEST RESULT																
Temperature characteristics	The test shall be performed after the sample has stabilized in an ambient temperature of -40 to +105 ,and the value calculated based on the value applicable in a normal temperature of +20 .	L ₂₀ ±10%	<table border="1"> <thead> <tr> <th>L</th> <th>-40C</th> <th>20C</th> <th>105C</th> </tr> </thead> <tbody> <tr> <td>Avg.</td> <td>-3.91</td> <td>0.00</td> <td>3.81</td> </tr> <tr> <td>Max.</td> <td>-3.09</td> <td>0.00</td> <td>4.79</td> </tr> <tr> <td>Min.</td> <td>-4.55</td> <td>0.00</td> <td>2.50</td> </tr> </tbody> </table>	L	-40C	20C	105C	Avg.	-3.91	0.00	3.81	Max.	-3.09	0.00	4.79	Min.	-4.55	0.00	2.50
L	-40C	20C	105C																
Avg.	-3.91	0.00	3.81																
Max.	-3.09	0.00	4.79																
Min.	-4.55	0.00	2.50																
Thermal shock	<p>The test shall be performed upon completion of 100 cycles in accordance with the conditions in the figure below, the measurement shall be made after the sample has been left in a normal temperature and normal humidity more than 12hours.</p>	No mechanical damage. L/Lo ±10%	<table border="1"> <thead> <tr> <th>L</th> <th>Initial</th> <th>Final</th> </tr> </thead> <tbody> <tr> <td>Avg.</td> <td>0.00</td> <td>0.22</td> </tr> <tr> <td>Max.</td> <td>0.00</td> <td>1.38</td> </tr> <tr> <td>Min.</td> <td>0.00</td> <td>-0.69</td> </tr> </tbody> </table>	L	Initial	Final	Avg.	0.00	0.22	Max.	0.00	1.38	Min.	0.00	-0.69				
L	Initial	Final																	
Avg.	0.00	0.22																	
Max.	0.00	1.38																	
Min.	0.00	-0.69																	
Low temperature storage	This test shall be performed upon completion of 1000±12hours in an atmosphere with a temperature of -40±2 Upon completion of the test, the measurement shall be made after The sample has been left in a normal temperature and normal humidity more than 12hours.	No mechanical damage. L/Lo ±10%	<table border="1"> <thead> <tr> <th>L</th> <th>Initial</th> <th>Final</th> </tr> </thead> <tbody> <tr> <td>Avg.</td> <td>0.00</td> <td>1.22</td> </tr> <tr> <td>Max.</td> <td>0.00</td> <td>3.56</td> </tr> <tr> <td>Min.</td> <td>0.00</td> <td>-0.32</td> </tr> </tbody> </table>	L	Initial	Final	Avg.	0.00	1.22	Max.	0.00	3.56	Min.	0.00	-0.32				
L	Initial	Final																	
Avg.	0.00	1.22																	
Max.	0.00	3.56																	
Min.	0.00	-0.32																	
Continuous operation in high temperature	The sample shall be left for 1000±12hours in an atmosphere with a temperature of +105±2 , under supplying rated current.Upon completion of the test, the measurement shall be made after the sample has been left in a normal temperature and normal humidity more than 12hours.	No mechanical damage. L/Lo ±10%	<table border="1"> <thead> <tr> <th>L</th> <th>Initial</th> <th>Final</th> </tr> </thead> <tbody> <tr> <td>Avg.</td> <td>0.00</td> <td>0.75</td> </tr> <tr> <td>Max.</td> <td>0.00</td> <td>1.52</td> </tr> <tr> <td>Min.</td> <td>0.00</td> <td>0.22</td> </tr> </tbody> </table>	L	Initial	Final	Avg.	0.00	0.75	Max.	0.00	1.52	Min.	0.00	0.22				
L	Initial	Final																	
Avg.	0.00	0.75																	
Max.	0.00	1.52																	
Min.	0.00	0.22																	
Continuous operation in moisture	The sample shall be left for 1000±12hours in an atmosphere with a temperature of +60±3 and a humidity(RH)of 90-95%,under supplying rated current.Upon completion of the test,the measurement shall be made after the sample has been left in a normal temperature and normal humidity more than 12hours.	No mechanical damage. L/Lo ±10%	<table border="1"> <thead> <tr> <th>L</th> <th>Initial</th> <th>Final</th> </tr> </thead> <tbody> <tr> <td>Avg.</td> <td>0.00</td> <td>0.51</td> </tr> <tr> <td>Max.</td> <td>0.00</td> <td>2.14</td> </tr> <tr> <td>Min.</td> <td>0.00</td> <td>-0.49</td> </tr> </tbody> </table>	L	Initial	Final	Avg.	0.00	0.51	Max.	0.00	2.14	Min.	0.00	-0.49				
L	Initial	Final																	
Avg.	0.00	0.51																	
Max.	0.00	2.14																	
Min.	0.00	-0.49																	



Reflow Soldering

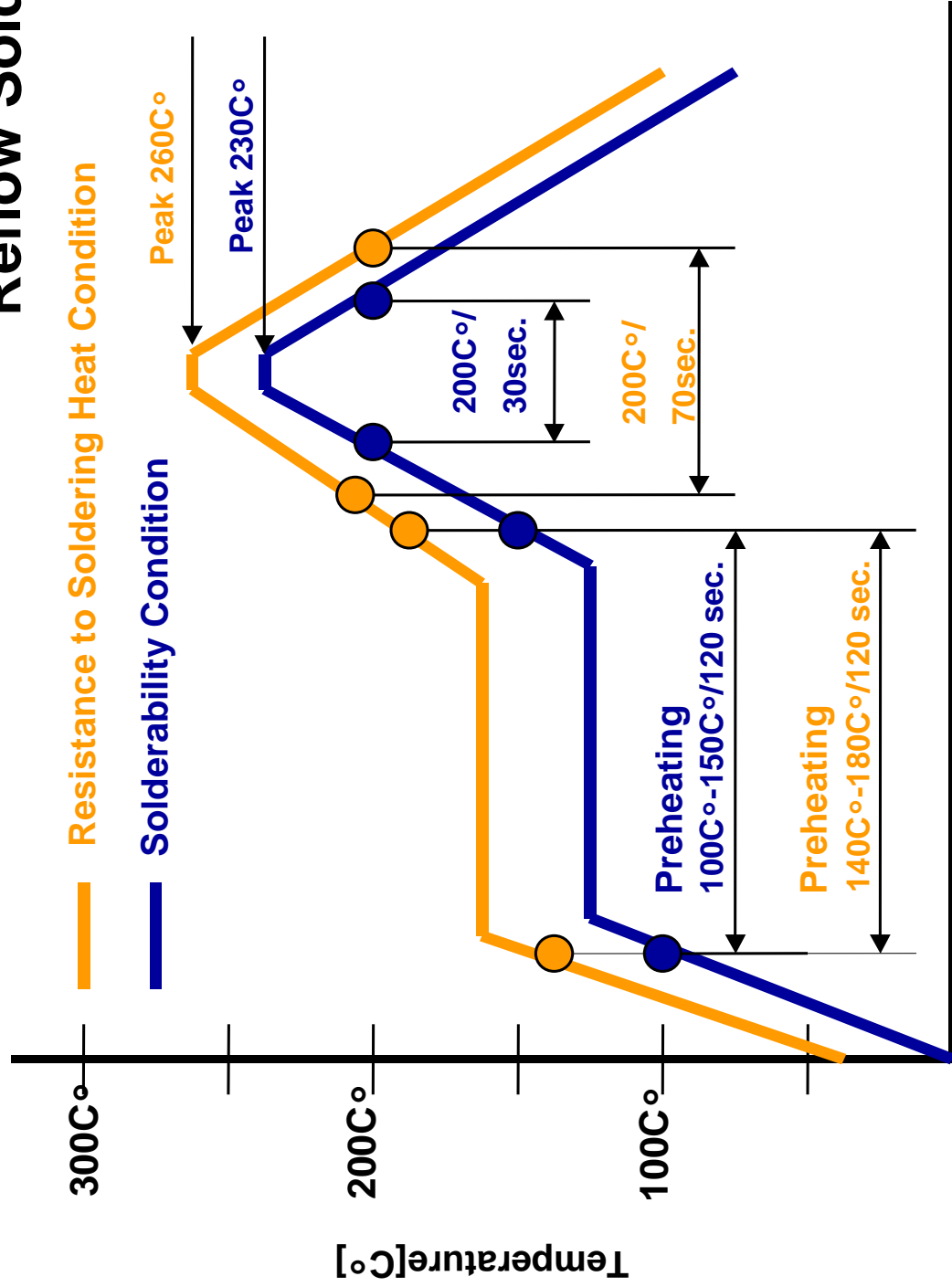



Technical Part and Leader Part Tape

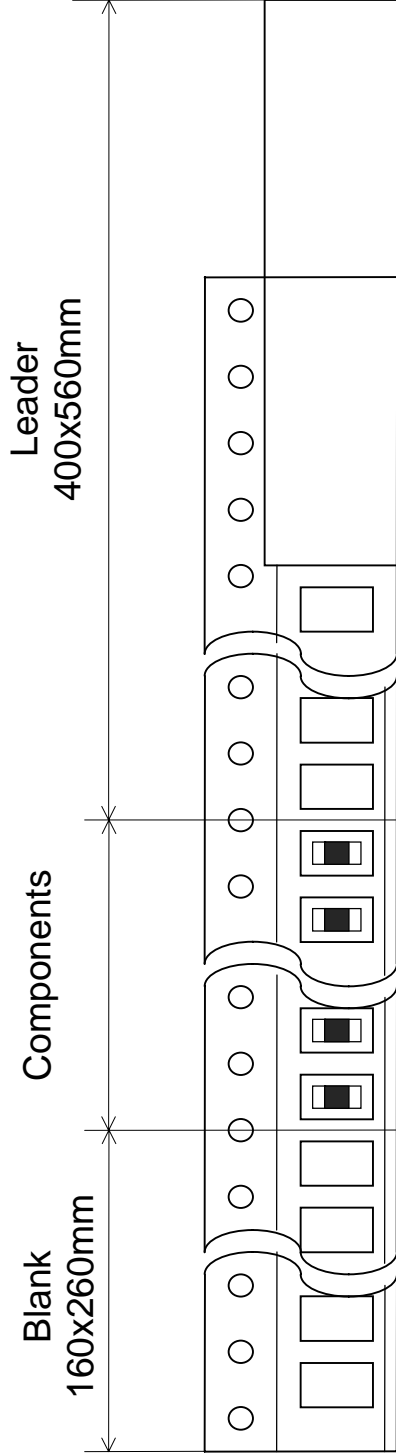

	Packing number
GLF1608Type	4,000pieces
GLF201208Type	2,000pieces
GLF2012Type	
GLF2518Type	
GLF251812Type	
GLC2518Type	

Reel Dimension

